



For over 10 years Prime Corporation has been devoted to providing its customers with the highest quality Surgical, Dental, Beauty and Podiatry Instruments.

Prime Corporation is committed to provide you with the highest quality instruments. We are the original equipment manufacturer (OEM) for all above mention instruments.

Our production depth covers thousands of instruments ranging from the typical instruments use in clinic to sophisticated instruments required during surgeries. We deem, however, pertinent to submit further that the range and scope of our production activities is not limited to our production literature. We can produce instruments even if not depicted in our online catalogues. We receive samples, photos or references from the world-renowned companies catalogues.

### **QUALITY/ INNOVATION**

At Prime Corporation the quality is set in motion through motivated specifications planning by trained technical persons. The computer added design and imaging provide visual instruments a set configuration. This simplifies each aspect of instruments manufacturing.

### **QUALITY CERTIFICATIONS:**

We are ISO 9001:2015, ISO 13485:2016, CE MARK, CGMP approved.

### **COMMITMENT:**

Our commitment is to meet the changing needs of healthcare systems and to lead the industry by providing quality surgical instruments and dental instruments at competitive price.

We understand the diverse needs of our customers and know that quality along with delivery time are the most important and common requirements of our customers from both segments. This Realization allows us to serve our customers in the most efficient and cost effective manners.

Wish you all the Best.

Prime Corporation Team



01		Scalpels Skalpelle Bisturías	Page 01 to 15
02		Diagnostics Diagnostik Diagnóstico	Page 16 to 21
03		Anaesthesia Narkose Anestesia	Page 22 to 37
04		Scissors Scheren Tijeras	Page 38 to 64
05		Super-Cut Scissors Super-Cut Scheren Tijeras Super-Cut	Page 65 to 74
06		TC Scissors TC Scheren Tijeras TC	Page 75 to 84
07		TC Super-Cut Scissors TC Super-Cut Scheren Tijeras Super-Cut TC	Page 85 to 86
08		Dressing & Tissue Forceps Anatomische und Chirurgische Pinzetten Pinzas de diseccion con dientes	Page 87 to 110
09		TC Forceps TC-Zange Pinzas TC	Page 111 to 114
10		Titanium Forceps Titan-Pinzetten Pinzas de titanio	Page 115 to 116
11		Artery Forceps Arterienklemmen Pinzas hemostáticas	Page 117 to 157
12		Cotton Swab Forceps Tupfer-und Kornzangen Pinzas para tapones y curaciones	Page 158 to 163
13		Probes, Applicators, Spatulas Sonden, Watteträger, Spatel Sondas, Porta-algodones, Espátulas	Page 164 to 169

Page 170 to 268	<b>Bone Surgery</b> Knochenchirurgie Cirugía ósea		<b>14</b>
Page 269 to 274	<b>Plaster Instruments</b> Plaster Instrumente Instrumentos de yeso		<b>15</b>
Page 275 to 345	<b>Retractors</b> Wundhaken und -sperrer Separadores		<b>16</b>
Page 346 to 372	<b>Suture</b> Naht Sutura		<b>17</b>
Page 373 to 387	<b>Neurosurgery</b> Neurochirurgie Neuro Cirugía		<b>18</b>
Page 388 to 498	<b>Cardiovascular Surgery</b> Herz- und Gefäßchirurgie Cirugía cardiovascular		<b>19</b>
Page 499 to 511	<b>Tonsil</b> Mandel Amígdala		<b>20</b>
Page 512 to 540	<b>Otology</b> Otologie Otología		<b>21</b>
Page 541 to 574	<b>Rhinology</b> Rhinologie Rinología		<b>22</b>
Page 575 to 595	<b>Oral Instruments</b> Mund instrumente Cirugía oral		<b>23</b>
Page 596 to 619	<b>Stomach, Intestine, Rectum</b> Magen, Darm, Mastdarm Estómago, Intestinos, Recto		<b>24</b>
Page 620 to 638	<b>Kidney, Liver, Gall Stone, Urology</b> Niere, Leber, Galle, Urologie Riñón, Hígado, Bilis, Urología		<b>25</b>
Page 639 to 640	<b>Dermatology</b> Dermatologie Dermatología		<b>26</b>



27		<p>Tracheotomy Tracheotomie Traqueotomía</p>	Page 641 to 650
28		<p>Ophthalmology Ophthalmologie Oftalmología</p>	Page 651 to 681
29		<p>Gynecology Gynäkologie Ginecología</p>	Page 682 to 722
30		<p>Obstetrics Geburtshilfe Obstetricia</p>	Page 723 to 740
31		<p>Goitre Kropfchirurgie Bocio</p>	Page 741
32		<p>Sterilization Sterilisation Esterilización</p>	Page 742 to 743
33		<p>Asepsis Asepsis Asepsia</p>	Page 744 to 745
34		<p>Holloware Holloware holloware</p>	Page 746 to 753

**EN** Scalpels

**DE** Skalpelle

**ES** Bisturías

Page 1 to 15





- EN —● Scalpel Handles
- DE —● Skalpelli-Griffe
- ES —● Mangos de bisturios



**Standard**  
PC 01-1000-04  
# 4

PC 01-1001-4L # 4L  
PC 01-1001-4XL # 4XL

PC 01-1002-4L # 4L  
PC 01-1002-4XL # 4XL  
angled

PC 01-1003-07  
# 7

PC 01-1004-07  
# 7K

**Collin**  
PC 01-1005-08  
Fig. 8

- Scalpel Handles ● — EN
- Skalpelli-Griffe ● — DE
- Mangos de bisturios ● — ES



**Standard**  
PC 01-1006-03 # 3

PC 01-1007-03 # 3

PC 01-1008-04 # 4

PC 01-1009-3L # 3L  
PC 01-1009-3XL # 3XL

PC 01-1010-3L # 3L  
PC 01-1010-3XL # 3XL  
angled



- EN —● Scalpel Handles  
 DE —● Skalpelli-Griffe  
 ES —● Mangos de bisturios



**Collin**  
PC 01-1011-09  
Hollow, No. 9



**Super**  
PC 01-1012-10  
Hollow, No. 10



PC 01-1013-00  
Hollow, round



PC 01-1014-00  
Plastics

- Scalpel Handles ●— EN
- Skalpelli-Griffe ●— DE
- Mangos de bisturys ●— ES



Fig. 1 PC 01-1015-01      Fig. 2 PC 01-1015-02      Fig. 3 PC 01-1015-03      Fig. 4 PC 01-1015-04      Fig. 5 PC 01-1015-05

Fig. 6 PC 01-1015-06      Fig. 7 PC 01-1015-07      Fig. 8 PC 01-1015-08      Fig. 9 PC 01-1015-09      Fig. 10 PC 01-1015-10



- EN —● Dissecting Knives
- DE —● Anatomische Skalpelle
- ES —● Bisturios para disección anatómica



Fig. 1 PC 01-1016-01 Fig. 2 PC 01-1016-02 Fig. 3 PC 01-1016-03 Fig. 4 PC 01-1016-04 Fig. 5 PC 01-1016-05 Fig. 6 PC 01-1016-06 Fig. 7 PC 01-1016-07 Fig. 8 PC 01-1016-08 Fig. 9 PC 01-1016-09



17cm/6 3/4"



Fig. 10 PC 01-1016-10 Fig. 11 PC 01-1016-11 Fig. 12 PC 01-1016-12 Fig. 13 PC 01-1016-13 Fig. 14 PC 01-1016-14 Fig. 15 PC 01-1016-15 Fig. 16 PC 01-1016-16 Fig. 18 PC 01-1016-18



Fig. 27 PC 01-1016-27 Fig. 38 PC 01-1016-38 Fig. 40 PC 01-1016-40 Fig. 46 PC 01-1016-46 Fig. 61 PC 01-1016-61 Fig. 63 PC 01-1016-63

- Dissecting Knives ● — EN
- Anatomische Skalpelle ● — DE
- Bisturías para disección anatómica ● — ES



# SCALPEL

- EN —● Dissecting Knives
- DE —● Anatomische Skalpelle
- ES —● Bisturías para disección anatómica



◀ Fig. 1

**Bergmann**  
PC 01-1018-01  
14.5cm/5¾"



Fig. 2  
PC 01-1018-02



Fig. 3  
PC 01-1018-03



Fig. 4  
PC 01-1018-04

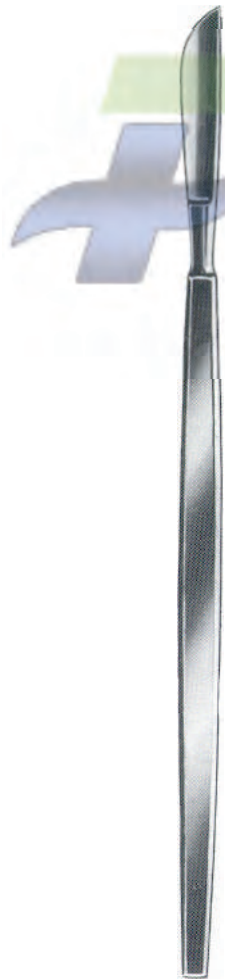

**Dieffenbach**  
13cm/5¼"



Fig. 1  
PC 01-1019-01



Fig. 2  
PC 01-1019-02



Fig. 3  
PC 01-1019-03



Fig. 4  
PC 01-1019-04



Fig. 5  
PC 01-1019-05



Fig. 6  
PC 01-1019-06



Fig. 7  
PC 01-1019-07



Fig. 8  
PC 01-1019-08



Fig. 9  
PC 01-1019-09



Fig. 10  
PC 01-1019-10



Fig. 11  
PC 01-1019-11



Fig. 12  
PC 01-1019-12



Dissecting Knives ●— EN  
 Anatomische Skalpelle ●— DE  
 Bisturías para disección anatómica ●— ES



**Simon**  
20cm/8"

Fig. 1 PC 01-1020-01  
 Fig. 2 PC 01-1020-02

Fig. 3 PC 01-1020-03  
 Fig. 4 PC 01-1020-04

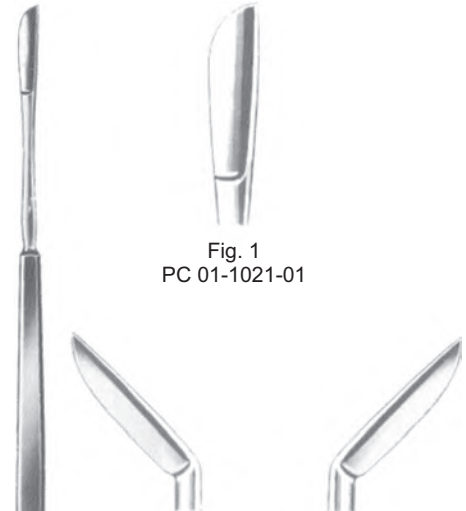

Fig. 1  
PC 01-1021-01

Fig. 2 PC 01-1021-02  
 Fig. 3 PC 01-1021-03

**Ulrich**  
22.5 cm/9"



**Simon**  
23.5 cm/9 1/4"

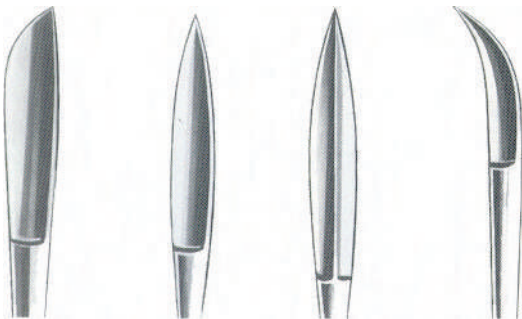

Fig. 1 PC 01-1022-01  
 Fig. 2 PC 01-1022-02  
 Fig. 3 PC 01-1022-03  
 Fig. 4 PC 01-1022-04



PC 01-1023-07  
7.5 cm/3"



PC 01-1024-08  
8 cm/3 1/4"

- EN —● Brain Knives  
 DE —● Hirmmesser  
 ES —● Cuchillos para cerebro

Brain knives

Post mortem knives

Autopsy knives

**Virchow**

PC 01-1025-16 26cm  
Blade Size 160mm

PC 01-1025-20 33.5cm  
Blade Size 200mm

PC 01-1025-24 38cm  
Blade Size 240mm

**Walb**

PC 01-1026-11 26cm  
Blade Size 110mm

PC 01-1026-14 29cm  
Blade Size 140mm

PC 01-1026-17 31cm  
Blade Size 170mm

PC 01-1027-10 25.5cm  
Blade Size 100mm

**Virchow**

PC 01-1028-08  
Blade Size 8.5 cm

Dissecting Knives ●— EN  
 Anatomische Skalpelle ●— DE  
 Bisturías para disección anatómica ●— ES



Length of blades		Collin	Liston	Catlin	Langenbeck	
cm	in					
9.5	3 3/4					PC 01-1033-09
11.0	4 1/2					
12.0	4 3/4					
13.0	5	PC 01-1029-13				
15.0	6					
16.0	6 1/4	PC 01-1029-16				
17.0	6 3/4		PC 01-1030-17			
19.0	7 1/2	PC 01-1029-19				
20.0	8		PC 01-1030-20			
22.0	8 3/4	PC 01-1029-22				
28.0	11	PC 01-1029-28				



- EN —● Dissecting Knives  
 DE —● Anatomische Skalpelle  
 ES —● Bisturías para disección anatómica

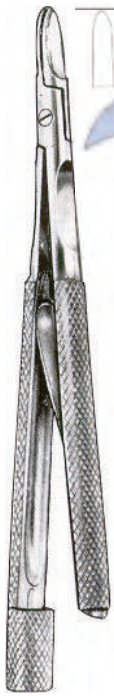

**Troutman-Chris**  
 PC 01-1034-09  
 9 cm/3½"

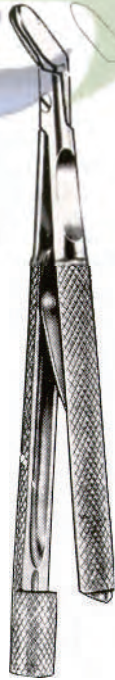

**Troutman-Chris**  
 PC 01-1035-09  
 9cm/3½"



PC 01-1036-11  
 11cm/4½"



**Castroviejo**  
 PC 01-1037-13  
 13cm/5¼"



PC 01-1038-18  
 18cm/7"

Dissecting Knives ●— EN  
 Anatomische Skalpelle ●— DE  
 Bisturías para disección anatómica ●— ES



Skull Breaker

PC 01-1039-14  
 14 cm/5½"

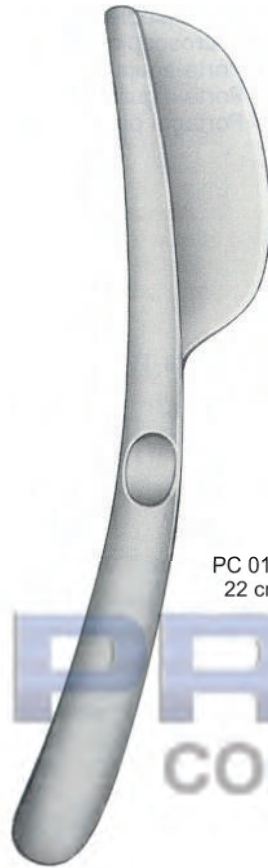

Rachiotome

PC 01-1040-22  
 22 cm/8¾"



23 mm

Osteotome

PC 01-1041-13  
 13 cm/5"

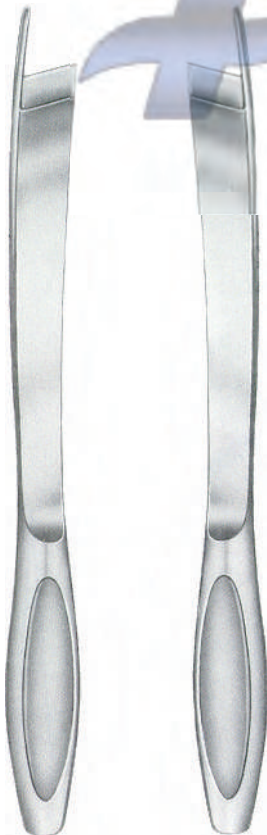

**Brunetti**      **Brunetti**  
 PC 01-1042-28    PC 01-1043-28  
 28.5 cm/11¼"

Muscle hooks



PC 01-1044-06  
 6.5 cm/2½"



PC 01-1045-07  
 7 cm/2¾"

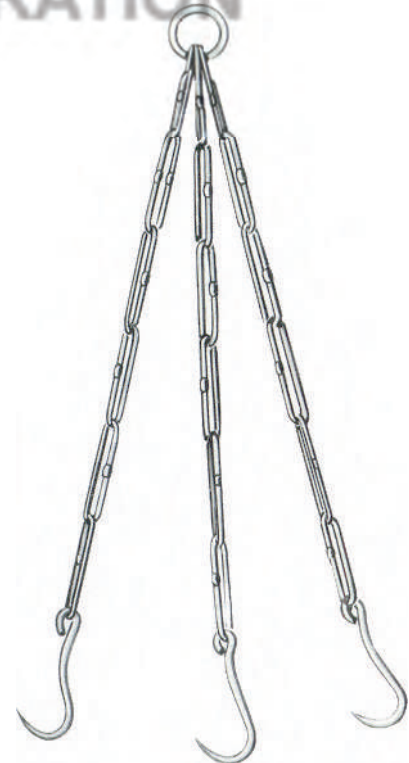

PC 01-1046-01

- EN —● Dissecting Needles  
 DE —● Sezieren Needles  
 ES —● Las agujas de disección



## Post mortem needles





- Dissecting Set — EN
- Sezieren Set — DE
- Conjunto de disección — ES



PC 01-1052-00



PC 01-1053-00



- EN —● Razor knives  
 DE —● Rasiermesser  
 ES —● Navajas



**SCHINK**  
 PC 01-1054-30  
 30 cm/12"



PC 01-1054-01



PC 01-1055-00



**HUMBY**  
 PC 01-1056-31  
 31 cm/12 1/2"



PC 01-1056-01



**SILVER**  
 PC 01-1057-19  
 19.5 cm/7 3/4"

**EN** Diagnostics

**DE** Diagnostik

**ES** Diagnóstico

Page 16 to 21

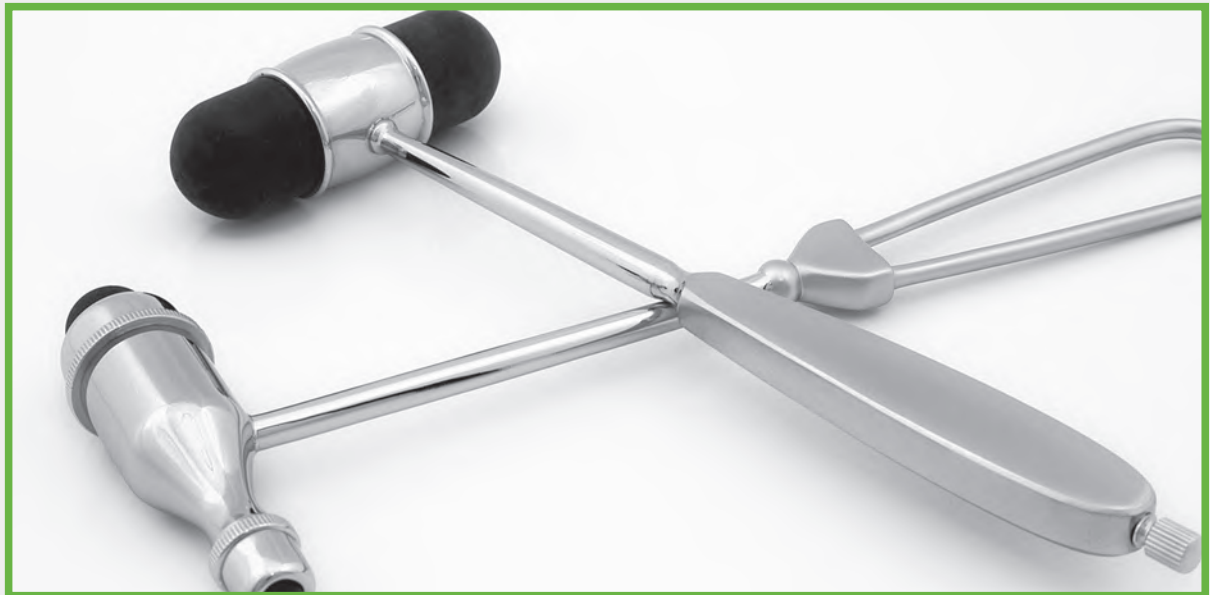

- EN —● Percussion Hammers
- DE —● Perkussionshämmer
- ES —● Martillos de percusión



**Taylor**  
PC 02-1101-18 18 cm/7½"  
PC 02-1101-20 20 cm/8"



**Dejerine**  
PC 02-1102-20  
20 cm/8"



**Dejerine**  
PC 02-1103-21 21 cm/8½"  
PC 02-1103-35 35 cm/14"



**Neuro-Duoflex**  
PC 02-1104-22  
22 cm/8¾"

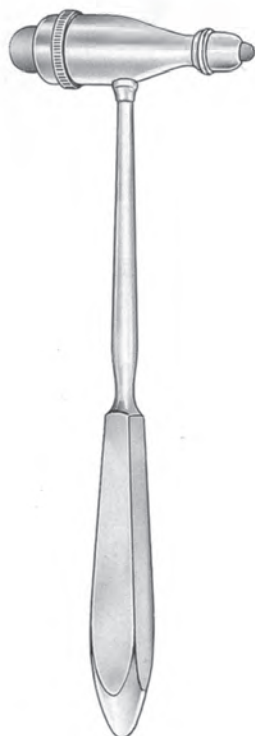

**Troemner**  
PC 02-1105-24  
24 cm/9¾"



**Berliner**  
PC 02-1106-17 17cm/7"  
PC 02-1106-20 20cm/8"



**Buck**  
PC 02-1107-18  
18 cm/7½"



**Buck (Telescopic)**  
PC 02-1108-18  
18 cm/7½"



Percussion Hammers ● EN  
 Perkussionshämmer ● DE  
 Martillos de percusión ● ES



**Traube**  
 PC 02-1109-16  
 16 cm/6 1/4"



**Troemner**  
 PC 02-1110-21  
 21cm/8 1/4"



**Divers-Duoflex**  
 PC 02-1111-22  
 22 cm/8 3/4"



**Babinsky**  
 PC 02-1112-22 22 cm/8 3/4"  
 PC 02-1112-25 25 cm/10"

**Rabiner**  
 PC 02-1113-23  
 23 cm/9 "



**National Hospital**  
 PC 02-1114-50 50 mm Ø  
 PC 02-1114-60 60 mm Ø  
 PC 02-1114-70 70 mm Ø  
 33 cm/13"



**Queen Sqaure**  
 PC 02-1115-26  
 26 cm/10 1/4"

- EN —● Sensibility Instruments
- DE —● Sensibilitäts-Instrumente
- ES —● Instrumentos para examinar la sensibilidad



**Pinard**  
PC 02-1116-18  
18 cm/7½"  
( wooden )



**Pinard**  
PC 02-1117-15  
15 cm/6"  
( plastic )



**Pinard**  
PC 02-1118-15  
15 cm/6"  
( aluminum )



**Pinard**  
PC 02-1119-15  
15 cm/6"  
( aluminum )



**Aly**  
PC 02-1120-17  
17cm/6¾"



**Wartenberg**  
PC 02-1121-19  
19cm/7½"



**Weber**  
PC 02-1122-09  
9cm/3½"



PC 02-1123-15 15 cm/6"  
PC 02-1123-30 30 cm/12"  
PC 02-1123-60 60 cm/24"

Examination and Measuring Instruments, Stethoscopes — EN  
 Prüf- und Meßinstrumente, Stethoskope — DE  
 Instrumentos para exámenes y medidas, Estetoscopios — ES

Goniometer

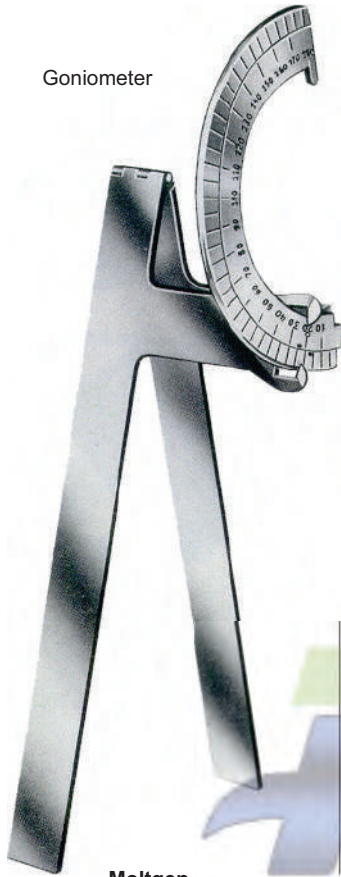

**Moltgen**  
PC 02-1124-00



**Townley**  
PC 02-1125-10  
10cm/4"

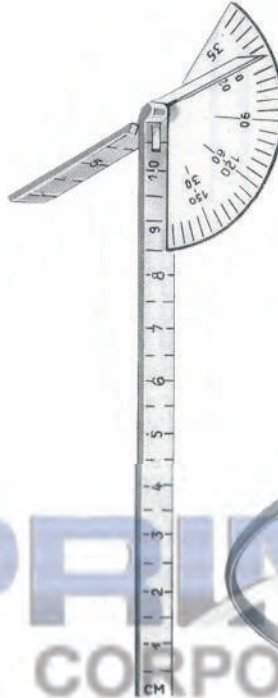

**Caroll**  
PC 02-1126-14  
14cm/5 1/2"



**Collin**  
for children PC 02-1127-01  
for adults PC 02-1127-02



**Ford Stethoscope**  
PC 02-1128-00  
Double Sided



**Dual Stethoscope**  
PC 02-1129-00  
Single Sided



- EN —● Head Lamps  
 DE —● Stimlampen  
 ES —● Lámparas de cabeza



PC 02-1130-00  
Head Lamp



PC 02-1131-00  
Head Lamp

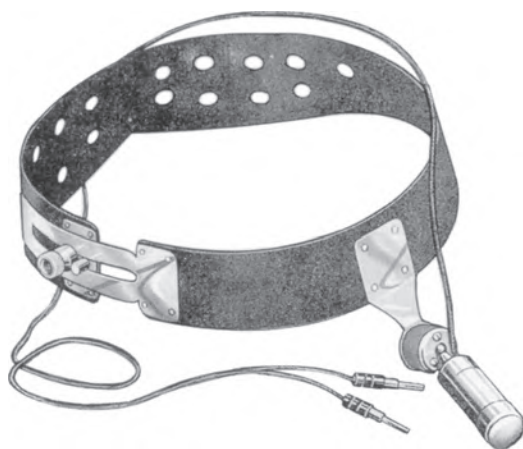

PC 02-1132-00  
Head Lamp



**Jansen**  
PC 02-1133-00  
Head Lamp

- Diagnostic Sets ●— EN
- Diagnostik - Bestecke ●— DE
- Juegos para diagnóstico ●— ES

Available in conventional and fiber



PC 02-1134-00  
Otoscope set in Case



PC 02-1135-00  
Otoscope set in Pouch

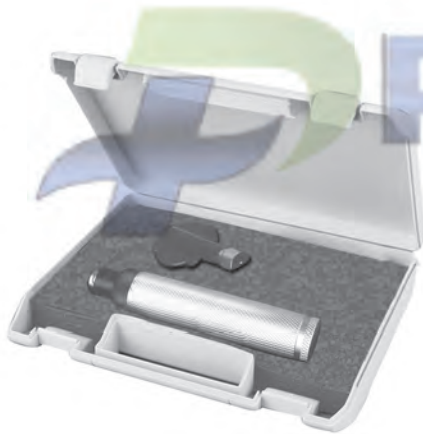

PC 02-1136-00  
Ophthalmoscope set



PC 02-1137-00  
Ophthalmoscope and Otoscope set



PC 02-1138-00  
Complete ENT set

**EN** Anaesthesia

**DE** Narkose

**ES** Anestesia

Page 22 to 37

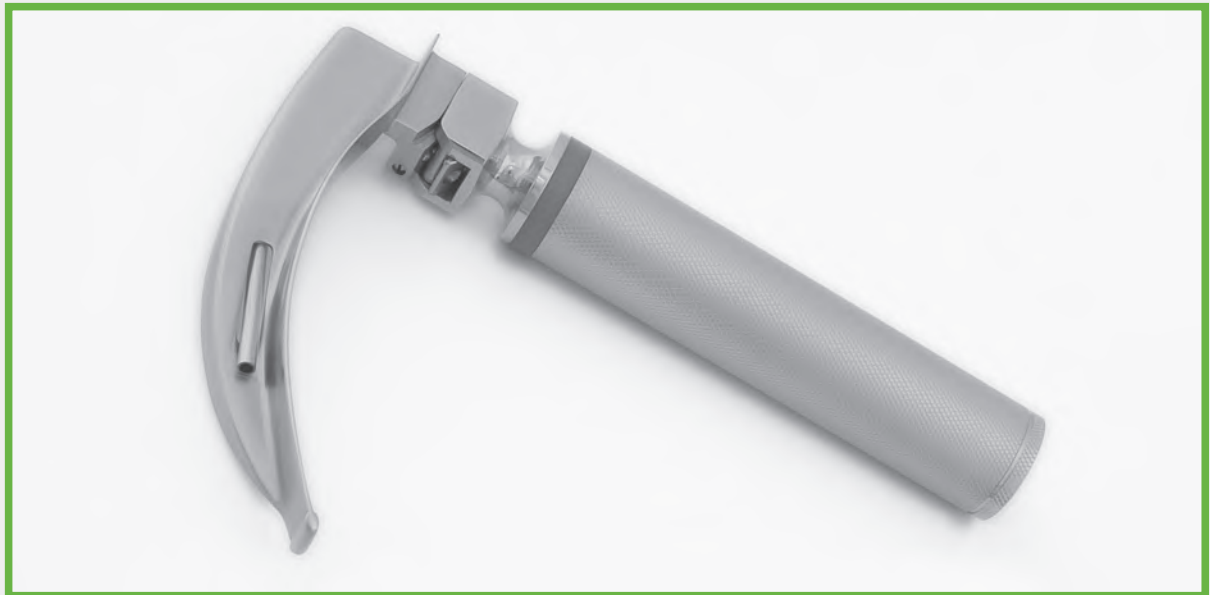



- EN —● Fiber Optic Laryngoscopes and Accessories
- DE —● Kaltlicht-Laryngoskope und Zubehör
- ES —● Laringoscopios de luz fria y accesorios



fiber optic



PC 03-1204-00  
Battery handle



PC 03-1203-00  
Fig. 0  
for babies  
55 mm



**McINTOSH**  
with fiberoptic

PC 03-1201-00  
set with 4 blades, battery handle  
(without batteries)  
Fig. 1 to 4, in case

PC 03-1202-00  
set with 3 blades, battery handle  
(without batteries)  
Fig. 1 to 3, in case



PC 03-1203-01  
Fig. 1  
for children  
70 mm

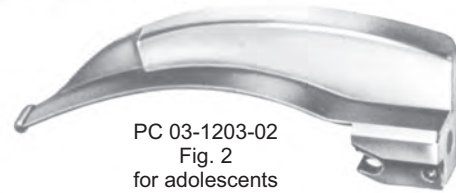

PC 03-1203-02  
Fig. 2  
for adolescents  
80 mm



PC 03-1203-03  
Fig. 3  
for women  
105 mm



PC 03-1203-04  
Fig. 4  
for men  
130 mm

Fiber Optic Laryngoscopes and Accessories ● EN  
 Kaltlicht-Laryngoskope und Zubehör ● DE  
 Laringoscopios de luz fria y accesorios ● ES



**FOREGGER**  
with fiberoptic

PC 03-1205-00  
set with 4 blades, battery handle  
(without batteries)  
Fig. 1 to 4, in case

PC 03-1205-01  
set with 3 blades, battery handle  
(without batteries)  
Fig. 2 to 4, in case



PC 03-1204-00  
Battery handle



Laryngoscope Sets  
fiber optic



PC 03-1206-00  
Fig. 0  
for babies  
55 mm



PC 03-1206-01  
Fig. 1  
for children  
70 mm

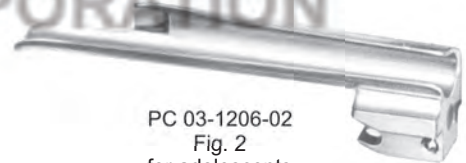

PC 03-1206-02  
Fig. 2  
for adolescents  
90 mm



PC 03-1206-03  
Fig. 3  
for women  
110 mm



PC 03-1206-04  
Fig. 4  
for men  
135 mm

- EN —● Laryngoscopes and Accessories
- DE —● Laryngoskope und Zubehör
- ES —● Laringoscopios y accesorios



**FOREGGER**  
PC 03-1207-00  
set with 3 blades  
Fig. 2 to 4, in case



**FOREGGER**  
PC 03-1208-00  
set with 4 blades  
in case  
Fig. 1 to 4, in case



PC 03-1209-01  
Fig. 1  
for children  
70 mm

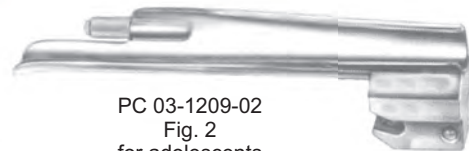

PC 03-1209-02  
Fig. 2  
for adolescents  
90 mm



PC 03-1209-03  
Fig. 3  
for women  
110 mm

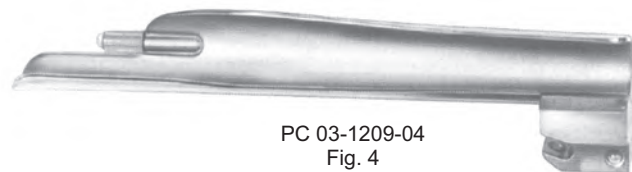

PC 03-1209-04  
Fig. 4  
for men  
135 mm

- Laryngoscopes and Accessories ● EN
- Laryngoskope und Zubehör ● DE
- Laringoscopios y accesorios ● ES



PC 03-1210-00  
Battery handle



PC 03-1211-00  
Battery handle



PC 03-1212-00  
Battery handle



PC 03-1213-00  
spare bulb small  
for blades fig. 0 to 1



PC 03-1214-00  
spare bulb large  
for blades fig. 2 to 4



- EN —● Fiber Optic Laryngoscopes and Accessories
- DE —● Kaltlicht-Laryngoskope und Zubehör
- ES —● Laringoscopios de luz fria y accesorios



**MILLER**  
PC 03-1215-00  
with battery handle (without batteries)  
and three laryngoscope blades  
fig. 1 to 3, complete, in case

**MILLER**  
PC 03-1216-00  
with battery handle (without batteries)  
and four laryngoscope blades  
fig. 1 to 4, complete, in case



Laryngoscope Sets  
fiber optic



PC 03-1217-00  
Fig. 0  
for babies  
55 mm

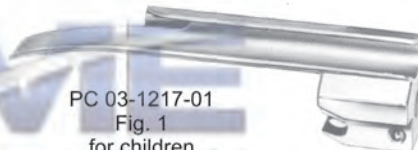

PC 03-1217-01  
Fig. 1  
for children  
80 mm



PC 03-1217-02  
Fig. 2  
for adolescents  
130 mm



PC 03-1217-03  
Fig. 3  
for women  
170 mm



PC 03-1217-04  
Fig. 4  
for men  
180 mm

Laryngoscopes and Accessories ●— EN  
 Laryngoskope und Zubehör ●— DE  
 Laringoscopios y accesorios ●— ES



**MILLER**  
 PC 03-1218-00  
 set with 4 blades, battery handle  
 (without batteries)  
 Fig. 1 to 4, in case

**MILLER-BABY**  
 PC 03-1219-00  
 set with 2 blades, battery handle  
 (without batteries)  
 Fig. 0 & 1, in case

**MILLER**  
 PC 03-1220-00  
 set with 3 blades, battery handle  
 (without batteries)  
 Fig. 1 to 3, in case

J



PC 03-1221-00  
 Fig. 0  
 for children  
 55 mm

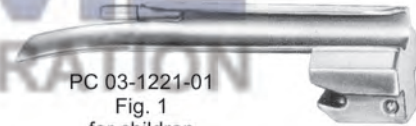

PC 03-1221-01  
 Fig. 1  
 for children  
 80 mm



PC 03-1221-02  
 Fig. 2  
 for adolescents  
 130 mm



PC 03-1221-03  
 Fig. 3  
 for women  
 170 mm



PC 03-1221-04  
 Fig. 4  
 for men  
 180 mm

EN —● Laryngoscopes and Accessories

DE —● Laryngoskope und Zubehör

ES —● Laringoscopios y accesorios



**GUEDEL-NEGUS**  
PC 03-1222-00  
set with 4 blades  
Fig. 1 to 4, in case

**GUEDEL-NEGUS**  
PC 03-1223-00  
set with 3 blades  
Fig. 2 to 4, in case



PC 03-1224-01  
Fig. 1  
for children  
70 mm



PC 03-1224-02  
Fig. 2  
for adolescent  
90 mm



PC 03-1224-03  
Fig. 3  
for women  
110 mm



PC 03-1224-04  
Fig. 4  
for men  
135 mm



Laryngoscopes and Accessories ●— EN  
 Laryngoskope und Zubehör ●— DE  
 Laringoscopios y accesorios ●— ES



**MCINTOSH**  
 PC 03-1225-00  
 set with 3 blades  
 Fig. 1 to 3, in case



PC 03-1227-00  
 Fig. 0  
 for babies  
 55 mm



PC 03-1227-01  
 Fig. 1  
 for children  
 70 mm



PC 03-1227-02  
 Fig. 2  
 for adolescent  
 90 mm



PC 03-1227-03  
 Fig. 3  
 for women  
 110 mm



PC 03-1227-04  
 Fig. 4  
 for men  
 130 mm



**MCINTOSH**  
 PC 03-1226-00  
 set with 4 blades  
 Fig. 1 to 4, in case

EN —● Fiber Optic Laryngoscopes and Accessories

DE —● Kaltlicht-Laryngoskope und Zubehör

ES —● Laringoscopios de luz fria y accesorios



fiber optic



PC 03-1228-00  
Battery handle (without batteries)  
with halogen bulb and green ring



PC 03-1229-00  
Battery handle (without batteries)  
with halogen bulb and green ring



PC 03-1230-00  
Spare bulb  
Krypton 2.5 V



PC 03-1231-00  
Spare bulb  
Xenon 2.5 V



PC 03-1232-00  
Spare bulb  
Halogen 2.5 V

- Catheter Introducing Forceps ● EN
- Kathetereinführzangen ● DE
- Pinzas para catéteres ● ES

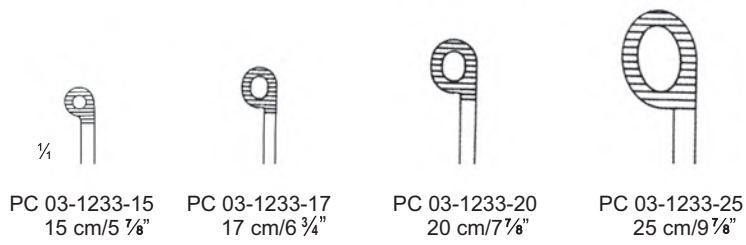

MAGILL

- EN —● Suction Tubes
- DE —● Sauger
- ES —● Tubos de aspiración



**YANKAUER**  
 PC 03-1234-31  
 31 cm/12 1/4"  
 with suction tip & connector

**YANKAUER**  
 PC 03-1235-31  
 (complete set)  
 31 cm/12 1/4"



**POOLE**  
 PC 03-1236-24  
 24 cm/9 1/2"  
 10 Ø

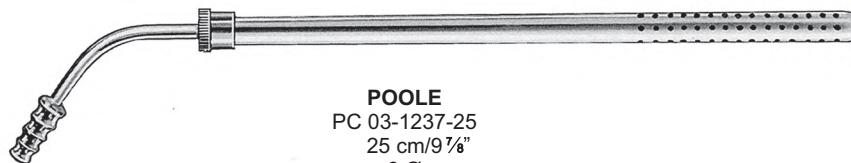

**POOLE**  
 PC 03-1237-25  
 25 cm/9 7/8"  
 8 Ø



Suction Tubes ●— EN  
 Sauger ●— DE  
 Tubos de aspiración ●— ES



**ADSON**  
 PC 03-1238-21  
 21 cm/8 1/4"  
 4mm Ø

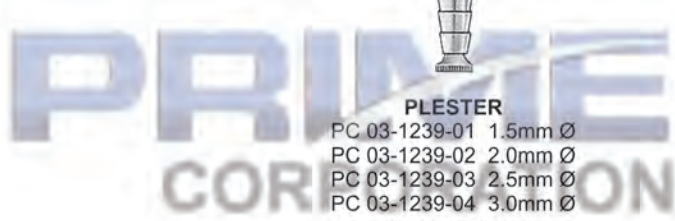

**PLESTER**  
 PC 03-1239-01 1.5mm Ø  
 PC 03-1239-02 2.0mm Ø  
 PC 03-1239-03 2.5mm Ø  
 PC 03-1239-04 3.0mm Ø  
 19.5 cm/7 3/4"

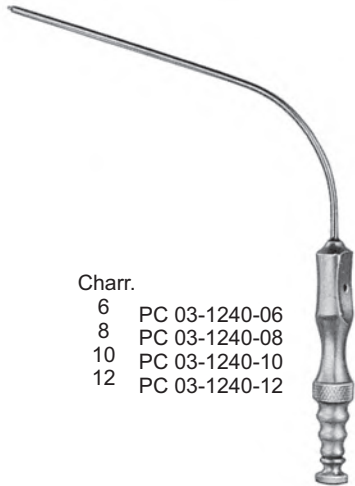

Charr.  
 6 PC 03-1240-06  
 8 PC 03-1240-08  
 10 PC 03-1240-10  
 12 PC 03-1240-12

**POPPE**  
 13 cm/5 1/8"



Charr.  
 6 PC 03-1241-06  
 7 PC 03-1241-07  
 8 PC 03-1241-08  
 9 PC 03-1241-09  
 10 PC 03-1241-10  
 11 PC 03-1241-11  
 12 PC 03-1241-12

**FRAZIER**  
 19 cm/7 1/2"

- EN —● Trocars
- DE —● Trokare
- ES —● Trócares



**HYDROCELE**  
 PC 03-1242-08 8 Fg.  
 PC 03-1242-09 9 Fg.  
 PC 03-1242-10 10 Fg.



**ACITES**  
 PC 03-1243-16 16 Fg.  
 PC 03-1243-21 21 Fg.

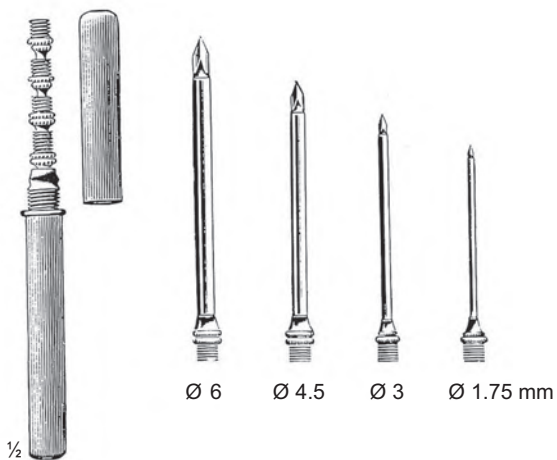

**UNIVERSAL**  
 PC 03-1244-30 Set of 3  
 PC 03-1244-40 Set of 4

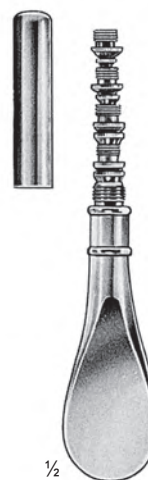

**UNIVERSAL**  
 PC 03-1245-30 Set of 3  
 PC 03-1245-40 Set of 4

Trocars ● — EN  
 Trokare ● — DE  
 Trócares ● — ES



**STANDARD**

- PC 03-1246-01 Ø 3.0 mm
- PC 03-1246-02 Ø 3.5 mm
- PC 03-1246-03 Ø 4.0 mm
- PC 03-1246-04 Ø 4.5 mm
- PC 03-1246-05 Ø 5.0 mm
- PC 03-1246-06 Ø 5.5 mm
- PC 03-1246-07 Ø 6.0 mm

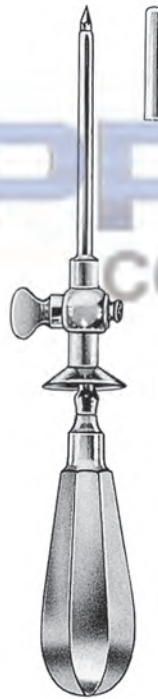

**STANDARD**

- PC 03-1247-01 Ø 3.0 mm
- PC 03-1247-02 Ø 3.5 mm
- PC 03-1247-03 Ø 4.0 mm
- PC 03-1247-04 Ø 4.5 mm
- PC 03-1247-05 Ø 5.0 mm
- PC 03-1247-06 Ø 5.5 mm
- PC 03-1247-07 Ø 6.0 mm



**STANDARD**

- PC 03-1248-01 Ø 3.0 mm
- PC 03-1248-02 Ø 3.5 mm
- PC 03-1248-03 Ø 4.0 mm
- PC 03-1248-04 Ø 4.5 mm
- PC 03-1248-05 Ø 5.0 mm
- PC 03-1248-06 Ø 5.5 mm
- PC 03-1248-07 Ø 6.0 mm

- EN —● Trocars
- DE —● Trokare
- ES —● Trócares

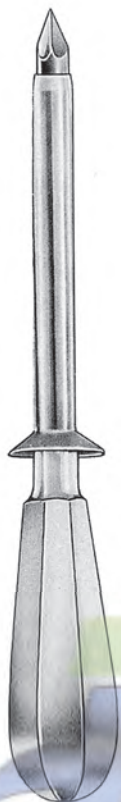

**NELSON**  
21 cm/8 1/4"

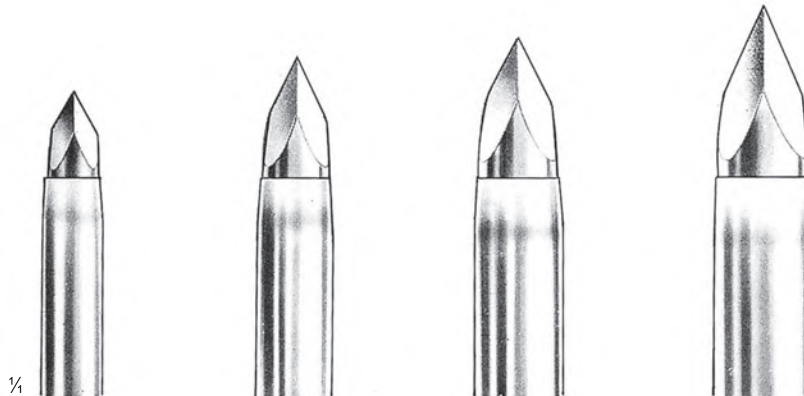
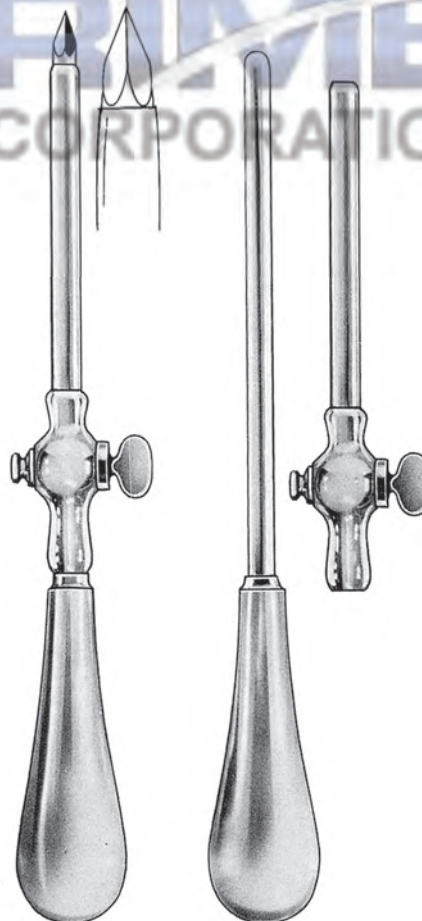

Fig. 1  
PC 03-1249-01

Fig. 2  
PC 03-1249-02

Fig. 3  
PC 03-1249-03

Fig. 4  
PC 03-1249-04



**BUELAU**  
PC 03-1250-24  
24 cm/9 1/2"  
8.0 mm Ø



Trocars, Guide Needles ●— EN  
 Trokare, Führungsnadeln ●— DE  
 Trócares, Agujas de guía ●— ES

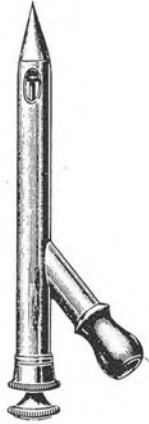

**PEAN**  
 PC 03-1251-13  
 13.5mm Ø



**OCHSNER**  
 PC 03-1252-04 4.0 mm Ø  
 PC 03-1252-05 5.5 mm Ø  
 PC 03-1252-06 6.5 mm Ø



**PIERCE**  
 PC 03-1253-03 15 cm/5 7/8" 3.0 mm Ø  
 PC 03-1253-04 15 cm/5 7/8" 4.0 mm Ø  
 PC 03-1253-05 15 cm/5 7/8" 5.0 mm Ø

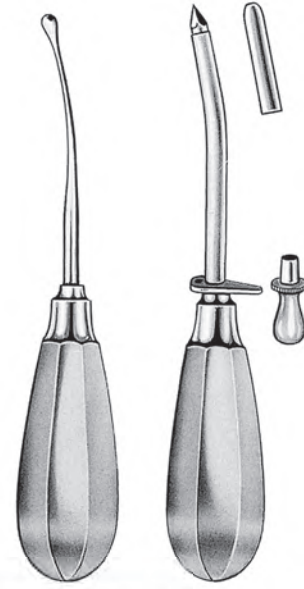

**KRAUSE**  
 PC 03-1254-15 15 cm/5 7/8"  
 5.5 mm Ø



**LICHTWITZ**  
 PC 03-1255-02  
 2.0 mm Ø

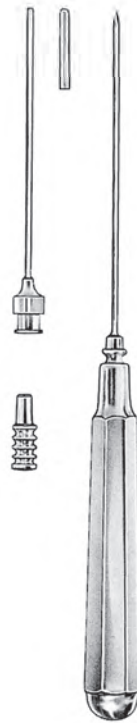

**LICHTWITZ**  
 PC 03-1256-19  
 19 cm/7 1/2"  
 1.8 mm Ø

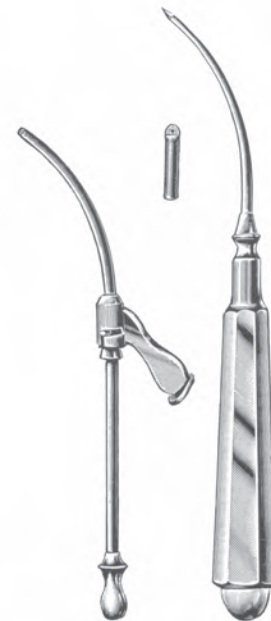

**COAKLEY**  
 PC 03-1257-16  
 16 cm/6 1/4"  
 2.25 mm Ø

**EN** Scissors

**DE** Scheren

**ES** Tijeras

Page 38 to 64

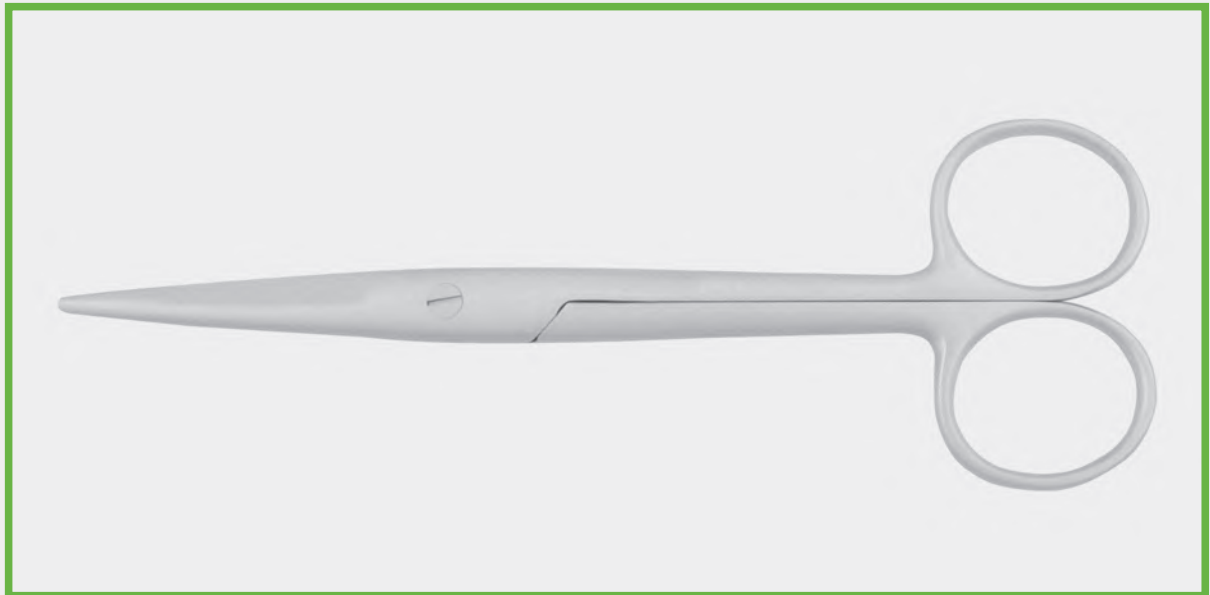

- EN —● Operating Scissors
- DE —● Chirurgische Scheren
- ES —● Tijeras quirúrgicas

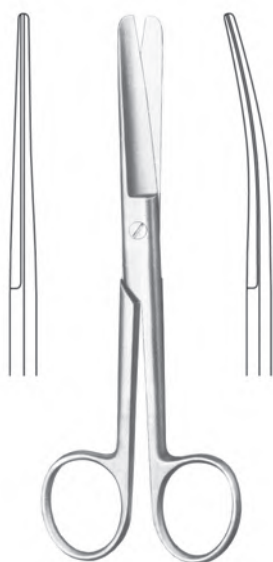

**STANDARD**  
blunt/blunt



**STANDARD**  
sharp/blunt

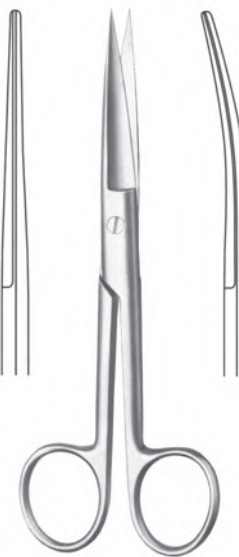

**STANDARD**  
sharp/sharp

cm	in	Straight	Curved	Straight	Curved	Straight	Curved
10.5	4 1/8"	PC 04-1301-10	PC 04-1302-10	PC 04-1303-10	PC 04-1304-10	PC 04-1305-10	PC 04-1306-10
11.5	4 1/2"	PC 04-1301-11	PC 04-1302-11	PC 04-1303-11	PC 04-1304-11	PC 04-1305-11	PC 04-1306-11
13.0	5 1/8"	PC 04-1301-13	PC 04-1302-13	PC 04-1303-13	PC 04-1304-13	PC 04-1305-13	PC 04-1306-13
14.5	5 3/4"	PC 04-1301-14	PC 04-1302-14	PC 04-1303-14	PC 04-1304-14	PC 04-1305-14	PC 04-1306-14
15.5	6 1/8"	PC 04-1301-15	PC 04-1302-15	PC 04-1303-15	PC 04-1304-15	PC 04-1305-15	PC 04-1306-15
16.5	6 1/2"	PC 04-1301-16	PC 04-1302-16	PC 04-1303-16	PC 04-1304-16	PC 04-1305-16	PC 04-1306-16
17.5	6 7/8"	PC 04-1301-17	PC 04-1302-17	PC 04-1303-17	PC 04-1304-17	PC 04-1305-17	PC 04-1306-17
18.5	7 1/4"	PC 04-1301-18	PC 04-1302-18	PC 04-1303-18	PC 04-1304-18	PC 04-1305-18	PC 04-1306-18
20.0	7 7/8"	PC 04-1301-20	PC 04-1302-20	PC 04-1303-20	PC 04-1304-20	PC 04-1305-20	PC 04-1306-20

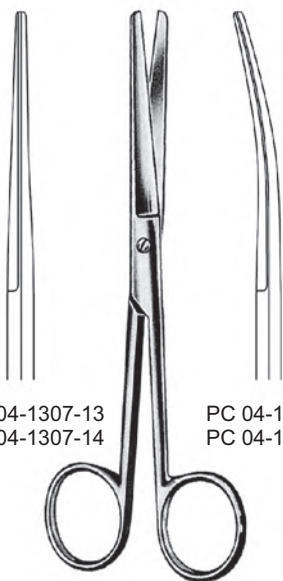

**GRAZIL**  
blunt/blunt

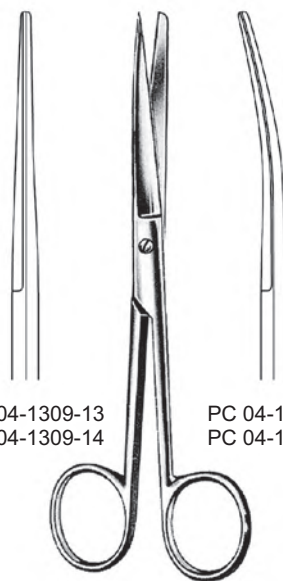

**GRAZIL**  
sharp/blunt

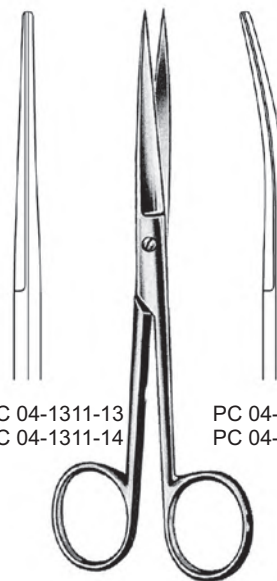

**GRAZIL**  
sharp/sharp

cm	in	Straight	Curved	Straight	Curved	Straight	Curved
13.0	5 1/8"	PC 04-1307-13	PC 04-1308-13	PC 04-1309-13	PC 04-1310-13	PC 04-1311-13	PC 04-1312-13
14.5	5 3/4"	PC 04-1307-14	PC 04-1308-14	PC 04-1309-14	PC 04-1310-14	PC 04-1311-14	PC 04-1312-14

Operating Scissors, Dissecting Scissors ●— EN  
 Chirurgische Scheren, Präparierscheren ●— DE  
 Tijeras quirúrgicas, Tijeras de disección ●— ES



**INCISION**  
 PC 04-1313-13 13 cm/5 1/8"  
 PC 04-1313-14 14.5 cm/5 3/4"



PC 04-1314-14 Straight  
 PC 04-1315-14 Curved  
 1/2  
**DEAVER**  
 14 cm/5 1/2"

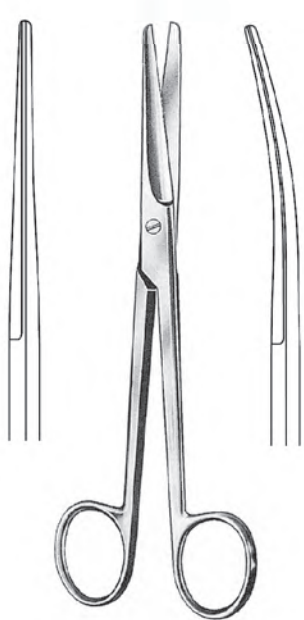

**MAYO**  
 straight  
 PC 04-1316-14 14.5 cm/5 3/4"  
 PC 04-1316-15 15 cm/5 7/8"  
 PC 04-1316-17 17 cm/6 3/4"  
 PC 04-1316-23 23 cm/9"  
 curved  
 PC 04-1317-14  
 PC 04-1317-15  
 PC 04-1317-17  
 PC 04-1317-23

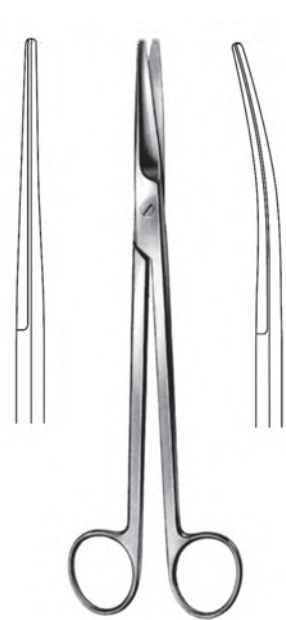

**MAYO-HARRINGTON**  
 straight  
 PC 04-1318-23 23 cm/9"  
 PC 04-1318-28 28 cm/11"  
 curved  
 PC 04-1319-23  
 PC 04-1319-28

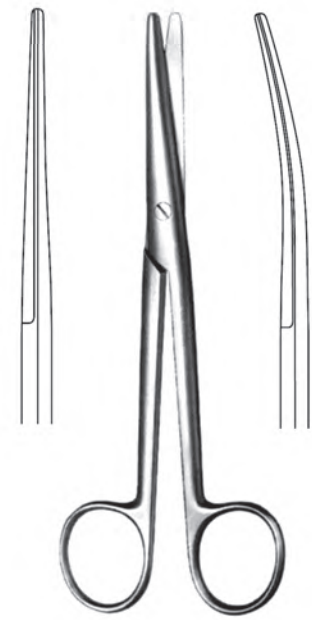

**MAYO-STILLE**  
 straight  
 PC 04-1320-15 15 cm/5 7/8"  
 PC 04-1320-16 16.5 cm/6 1/2"  
 PC 04-1320-17 17 cm/6 3/4"  
 PC 04-1320-19 19.5 cm/7 1/2"  
 PC 04-1320-21 21 cm/8 1/4"  
 curved  
 PC 04-1321-15  
 PC 04-1321-16  
 PC 04-1321-17  
 PC 04-1321-19  
 PC 04-1321-21



**SCISSORS**

- EN —● Dissecting Scissors, Gynecological Scissors
- DE —● Präparierscheren, Gynäkologische Scheren
- ES —● Tijeras de disección, Tijeras para ginecología



**MAYO-NOBLE**  
16.5 cm/6 1/2"

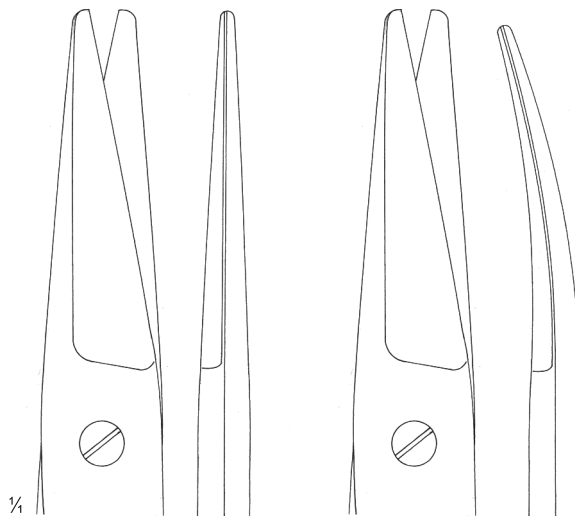

PC 04-1322-16  
straight

PC 04-1323-16  
curved



**WERTHEIM**

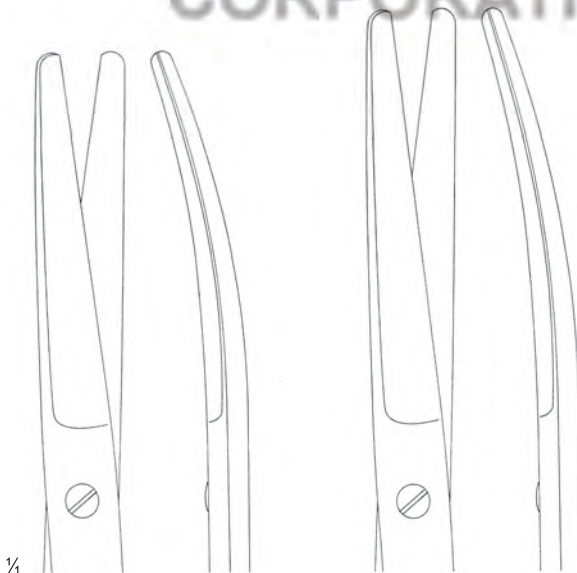

PC 04-1324-20  
20 cm/7 7/8"

PC 04-1324-23  
23 cm/9"

Gynecological Scissors, Dissecting Scissors — EN  
 Gynäkologische Scheren, Präparierscheren — DE  
 Tijeras para ginecología, Tijeras de disección — ES

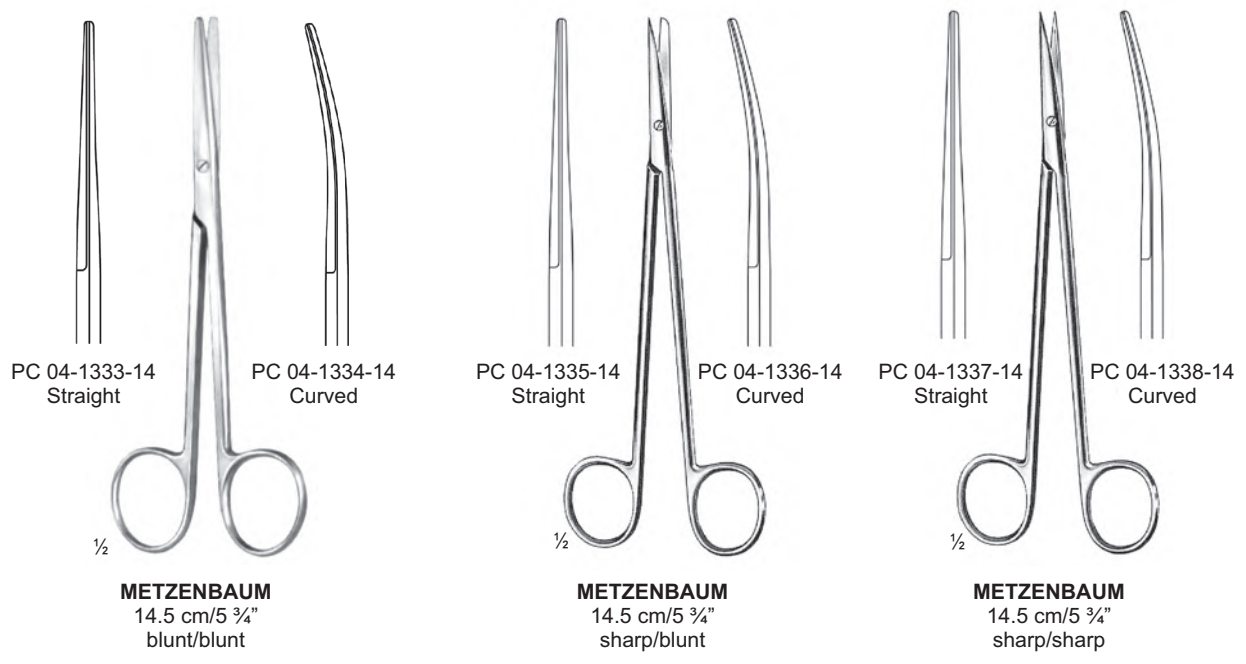
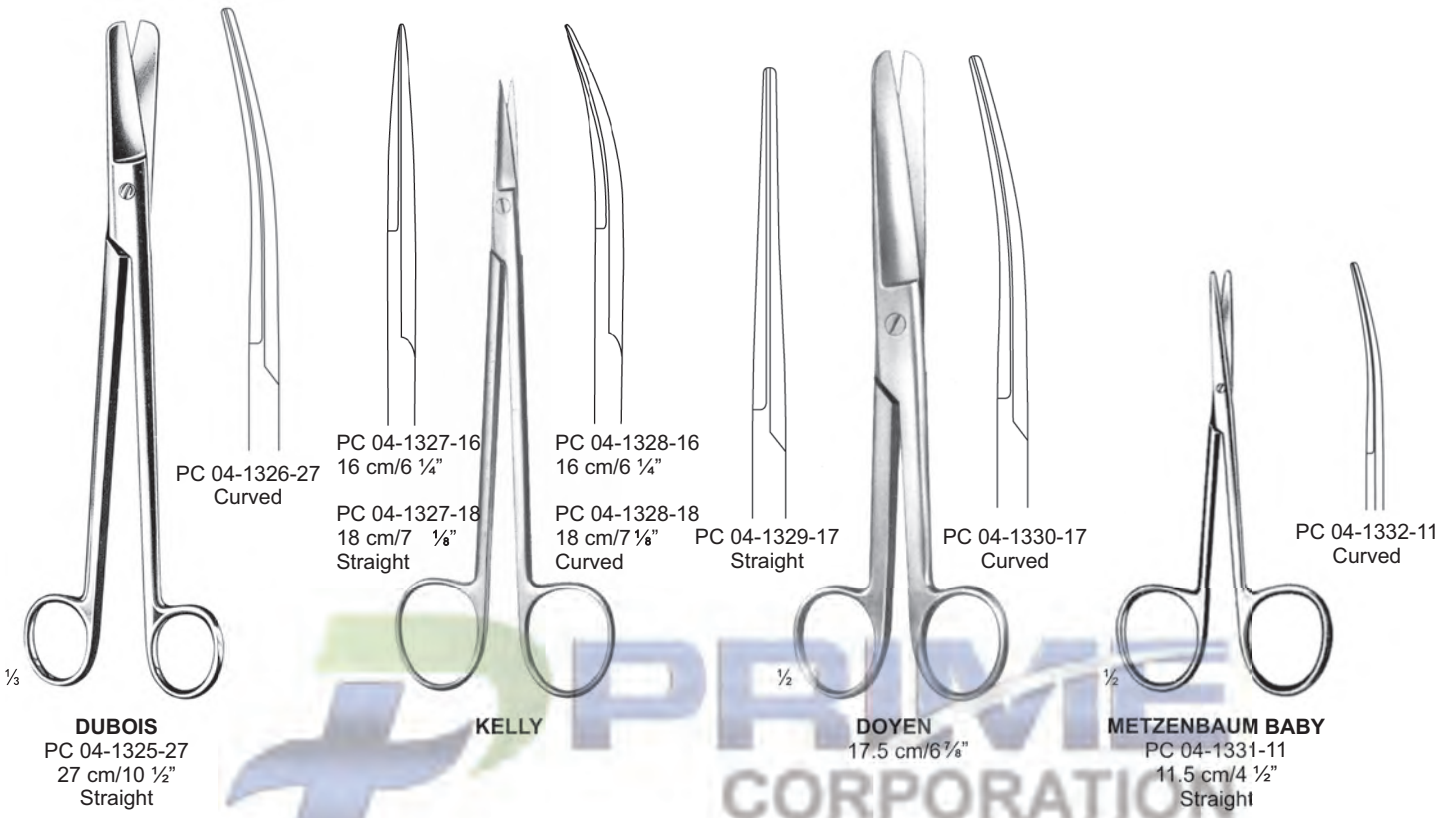

EN —● Dissecting Scissors  
 DE —● Präparierscheren  
 ES —● Tijeras de disección

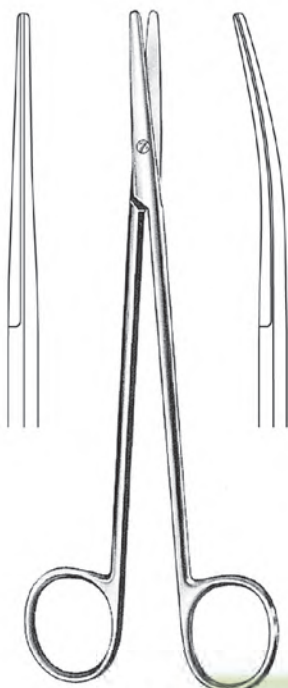

**METZENBAUM-NELSON**  
blunt/blunt

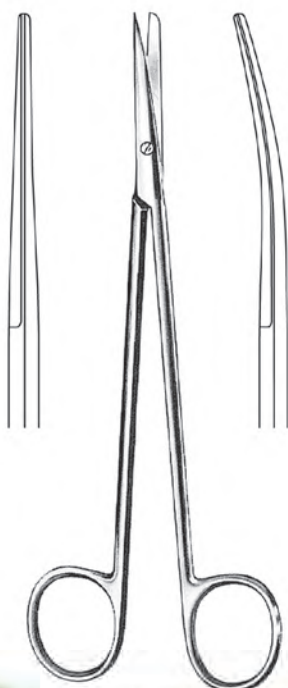

**METZENBAUM-NELSON**  
sharp/blunt

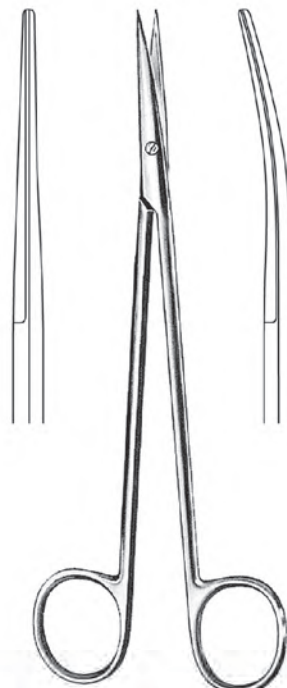

**METZENBAUM-NELSON**  
sharp/sharp

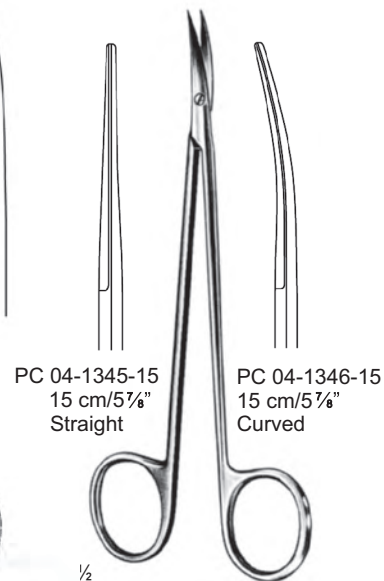

PC 04-1345-15  
15 cm/5 7/8"  
Straight

PC 04-1346-15  
15 cm/5 7/8"  
Curved

1/2

**NERVE DISSECTING SCISSORS**

cm	in	blunt/blunt		sharp/blunt		sharp/sharp	
		straight	curved	straight	curved	straight	curved
18	7 1/8"	PC 04-1339-18	PC 04-1340-18	PC 04-1341-18	PC 04-1342-18	PC 04-1343-18	PC 04-1344-18
20	7 7/8"	PC 04-1339-20	PC 04-1340-20	PC 04-1341-20	PC 04-1342-20	PC 04-1343-20	PC 04-1344-20
23	9"	PC 04-1339-23	PC 04-1340-23	PC 04-1341-23	PC 04-1342-23	PC 04-1343-23	PC 04-1344-23
25	9 7/8"	PC 04-1339-25	PC 04-1340-25	PC 04-1341-25	PC 04-1342-25	PC 04-1343-25	PC 04-1344-25
28	11"	PC 04-1339-28	PC 04-1340-28	PC 04-1341-28	PC 04-1342-28	PC 04-1343-28	PC 04-1344-28
30	11 3/4"	PC 04-1339-30	PC 04-1340-30	PC 04-1341-30	PC 04-1342-30	PC 04-1343-30	PC 04-1344-30

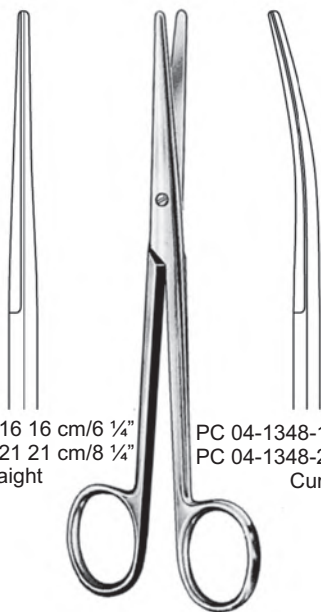

PC 04-1347-16 16 cm/6 1/4"  
PC 04-1347-21 21 cm/8 1/4"  
Straight

**LEXER**

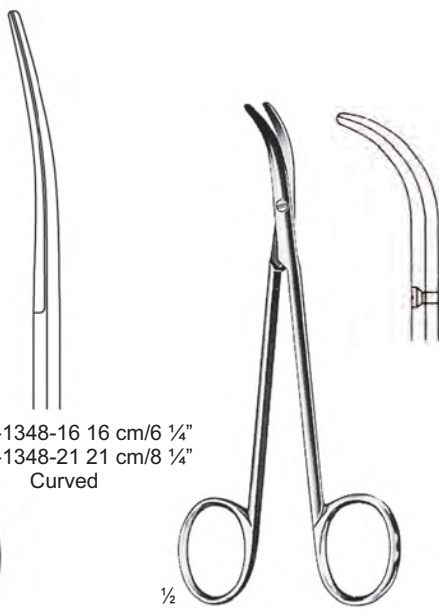

PC 04-1348-16 16 cm/6 1/4"  
PC 04-1348-21 21 cm/8 1/4"  
Curved

**FOMON**

PC 04-1349-13  
13.5 cm/5 3/8"

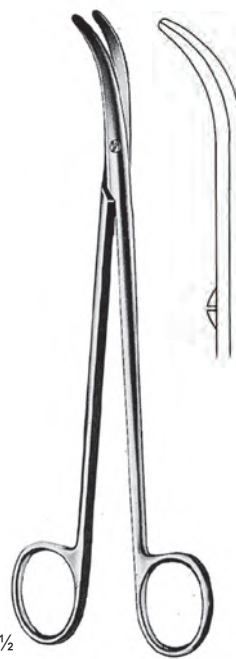

1/2

**THOREK**

PC 04-1350-19  
19 cm/7 1/2"

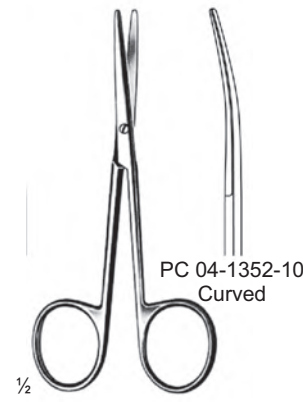

1/2

**LEXER-BABY**

PC 04-1351-10  
10 cm/3 7/8"  
Straight

PC 04-1352-10  
Curved

Plastic Surgery, Thorax and Vascular Scissors ● EN  
 Thoraxchernen, Gefabschernen ● DE  
 Tijeras Tracicas y Vasculares ● ES



PC 04-1354-12 12 cm/4 3/4"  
 PC 04-1354-15 15 cm/5 7/8"

**KILNER**  
 PC 04-1353-13  
 13 cm/5 1/8"

**CRAFOORD**  
 PC 04-1355-30  
 30 cm/11 3/4"

**SATINSKY**  
 PC 04-1356-24  
 24.5 cm/9 5/8"

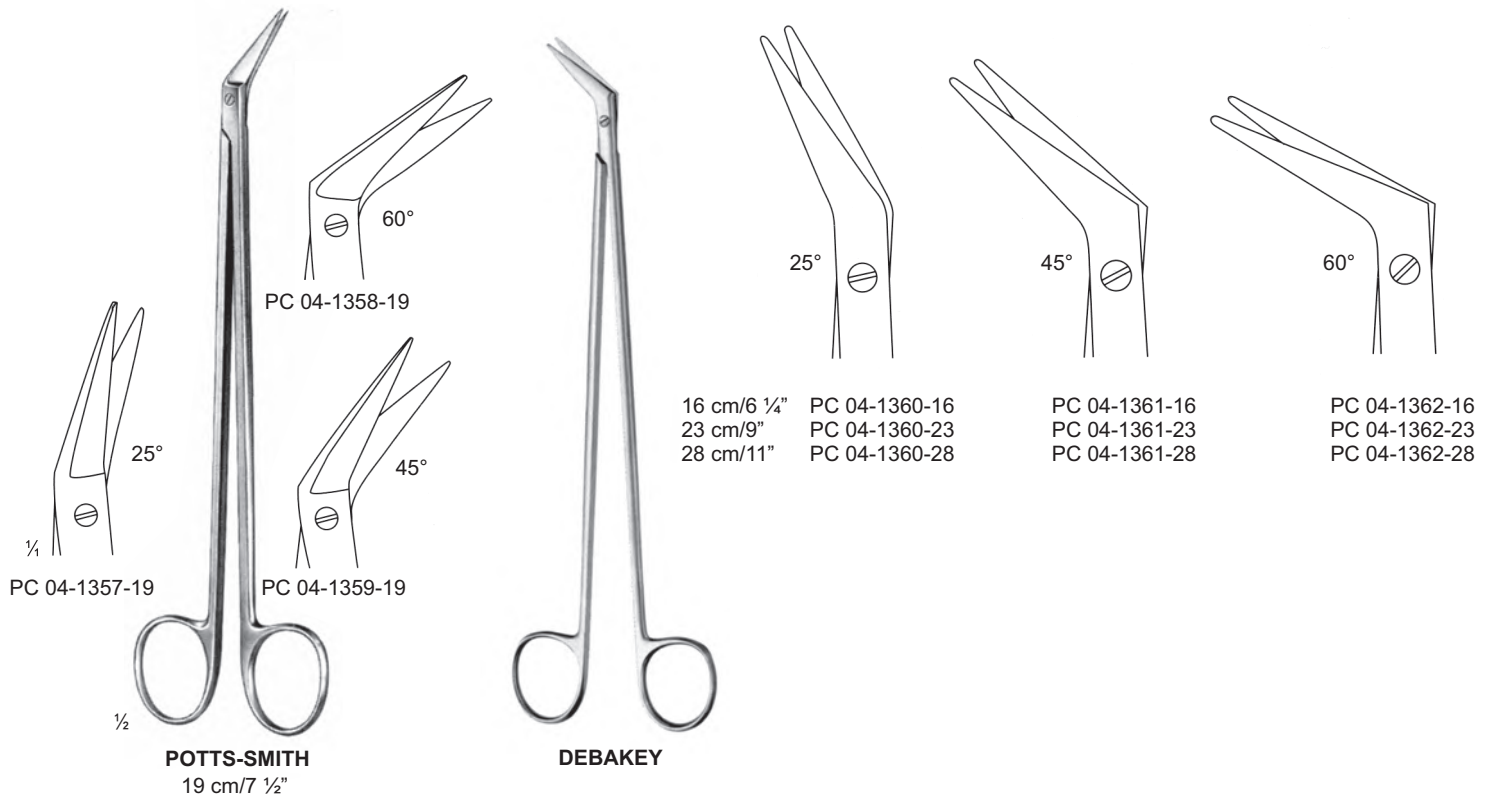

60°  
 PC 04-1358-19

25°

45°

60°

16 cm/6 1/4" PC 04-1360-16  
 23 cm/9" PC 04-1360-23  
 28 cm/11" PC 04-1360-28

PC 04-1361-16  
 PC 04-1361-23  
 PC 04-1361-28

PC 04-1362-16  
 PC 04-1362-23  
 PC 04-1362-28

25°  
 1/4"  
 PC 04-1357-19

45°  
 PC 04-1359-19

1/2"  
**POTTS-SMITH**  
 19 cm/7 1/2"

**DEBAKEY**



- EN —● Dissecting and Vascular Scissors
- DE —● Präparierschere, Gefäßscheren
- ES —● Tijeras para preparaciones y vasculares

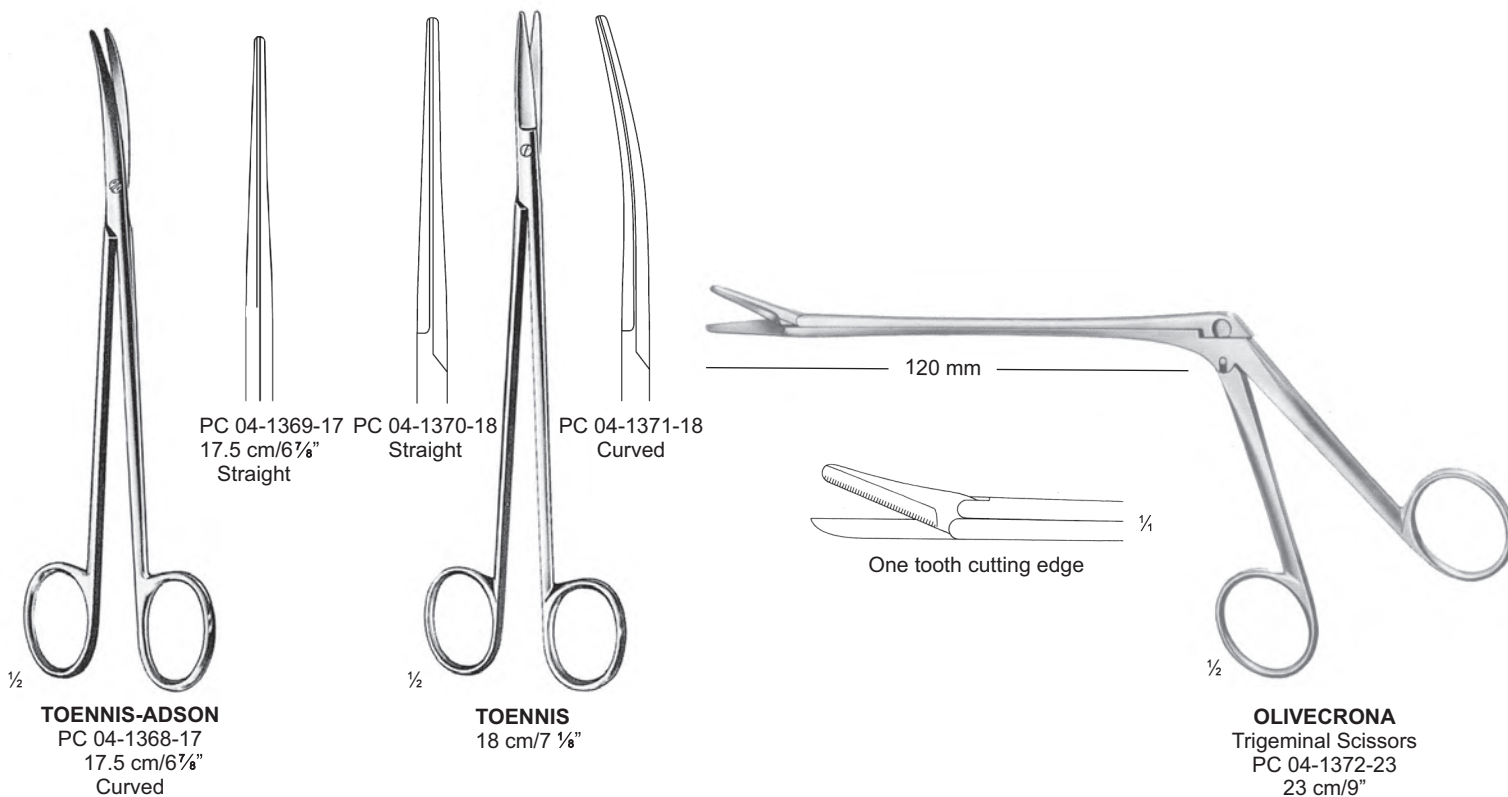

Cartilage Scissors, Dissecting Scissors, Rectal Scissors ● EN  
 Kapselschere, Präparierscheren, Mastdarm Scheren ● DE  
 Tijeras para preparaciones, Tijeras para rectales ● ES

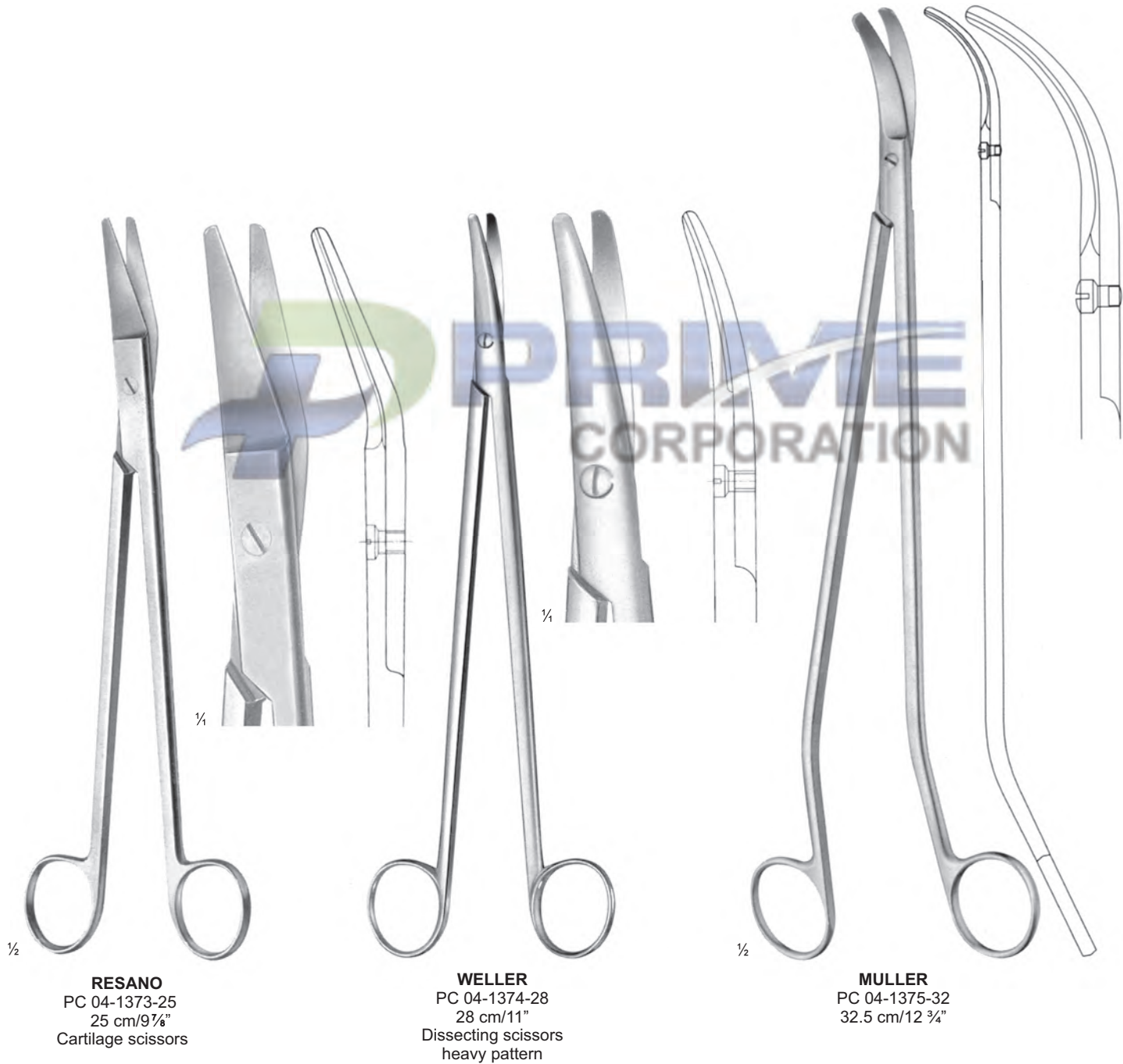

**RESANO**  
 PC 04-1373-25  
 25 cm/9<sup>7</sup>/<sub>8</sub>"  
 Cartilage scissors

**WELLER**  
 PC 04-1374-28  
 28 cm/11"  
 Dissecting scissors  
 heavy pattern

**MULLER**  
 PC 04-1375-32  
 32.5 cm/12 <sup>3</sup>/<sub>4</sub>"

**SCISSORS**

- EN —● Tonsil and Nasal Scissors
- DE —● Tonsillen-und-Nasenscheren
- ES —● Tijeras nasales y para amígdalas

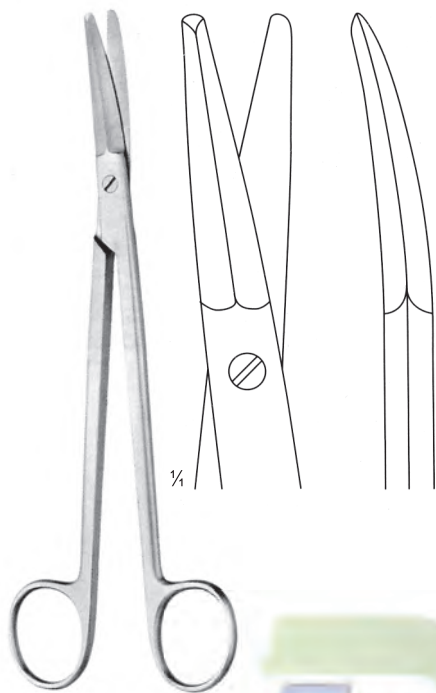

**BOETTCHER**  
PC 04-1376-18  
18 cm/7 1/8"

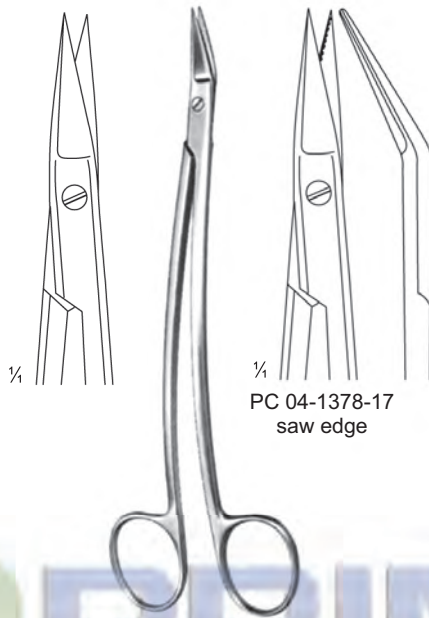

**DEAN**  
PC 04-1377-17  
17 cm/6 3/4"

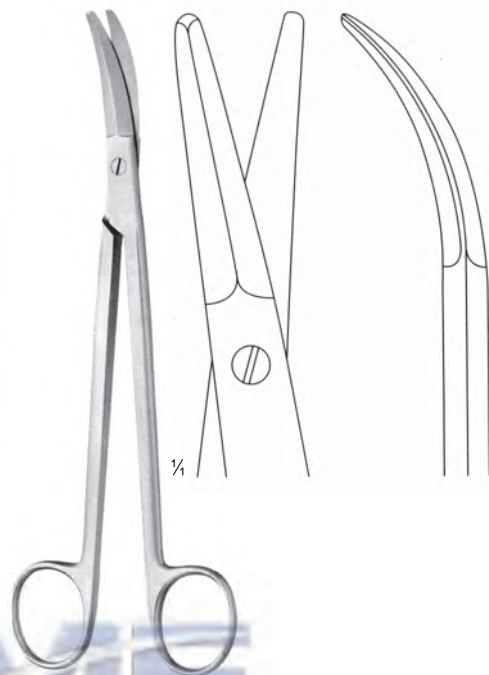

**PRINCE**  
PC 04-1379-17  
17.5 cm/6 7/8"

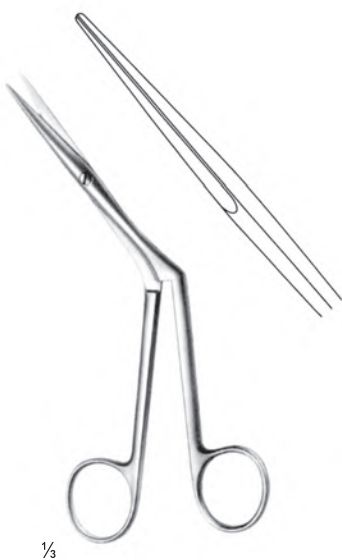

**HEYMANN**  
PC 04-1380-18  
18 cm/7 1/8"

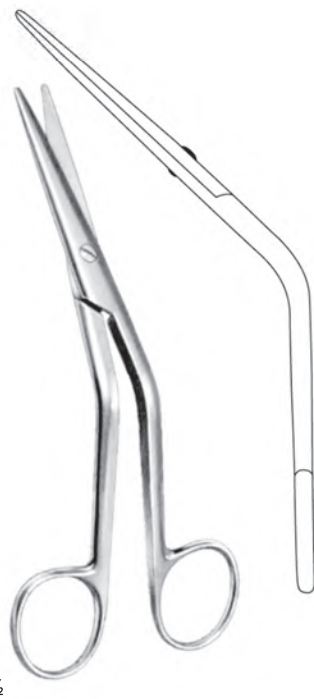

**COTTLE**  
PC 04-1381-16  
16 cm/6 1/4"



**FOMON**  
PC 04-1382-15  
15 cm/5 7/8"

Episiotomy and Umbilical Scissors — EN  
 Episiotomie-und Nabelschnurscheren — DE  
 Tijeras para episiotomia y umbilicales — ES

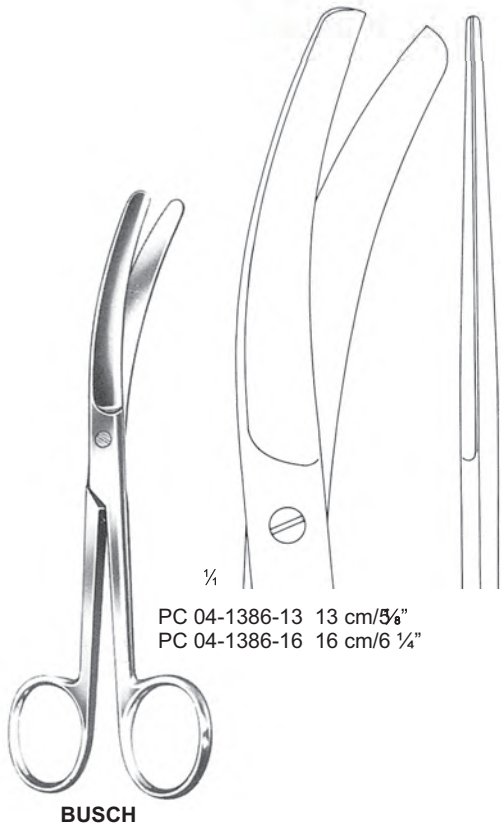

**BUSCH**

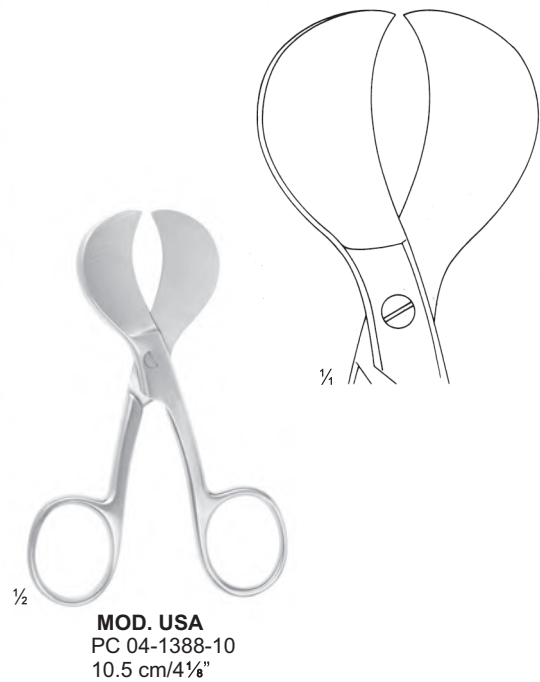
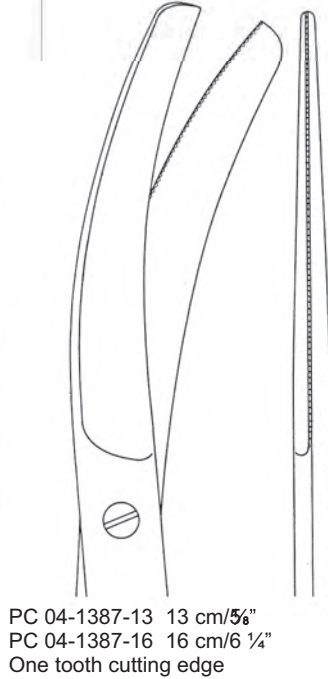

**MOD. USA**  
 PC 04-1388-10  
 10.5 cm/4 1/8"



- EN —● Episiotomy, Tonsil and Gynecological Scissors
- DE —● Episiotomie, Tonsillenscheren, Gynäkologische Scheren
- ES —● Episiotomía, Tijeras para amígdalas y ginecología

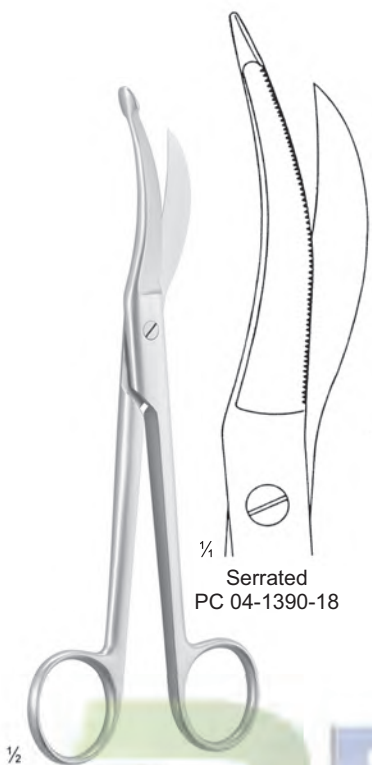

Serrated  
PC 04-1390-18

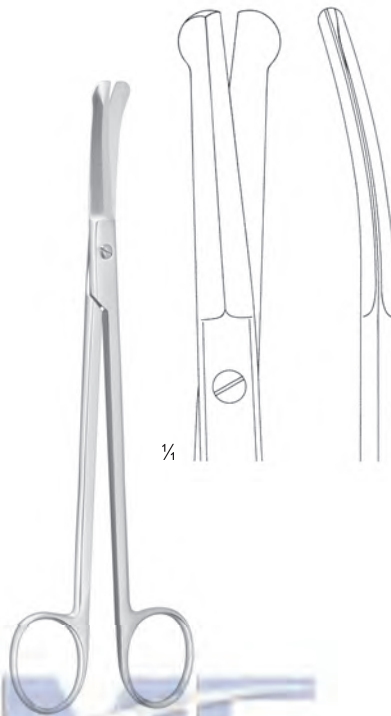

GOOD  
PC 04-1391-19  
19 cm/7 1/2"

1/2  
WALDMANN  
PC 04-1389-18  
18 cm/7 1/8"  
Non-Serrated



1/4  
PC 04-1392-20  
20 cm/7 7/8"  
straight

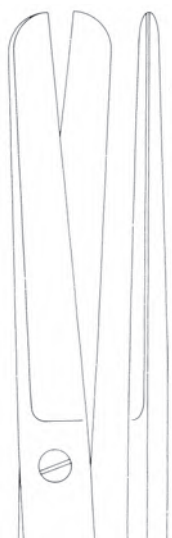

PC 04-1393-20  
20 cm/7 7/8"  
curved



PC 04-1394-23 23 cm/9"  
PC 04-1394-25 25 cm/9 7/8"  
Straight



PC 04-1395-23  
23 cm/9"  
curved

Gynecological Scissors, Delicate Dissecting Scissors — EN  
 Gynäkologische Scheren, Feine Präparierscheren — DE  
 Tijeras para ginecología, Tijeras finas de disección — ES



**SIMS-SIEBOLD**  
straight  
PC 04-1396-24  
24 cm/9 1/2"

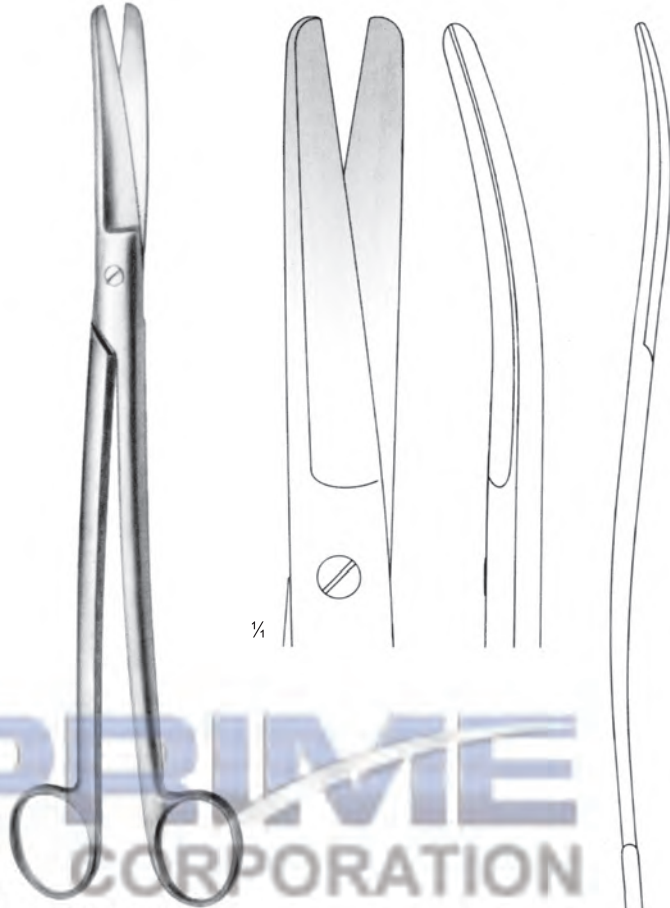

**SIMS-SIEBOLD**  
S-Shaped  
PC 04-1397-24  
24 cm/9 1/2"

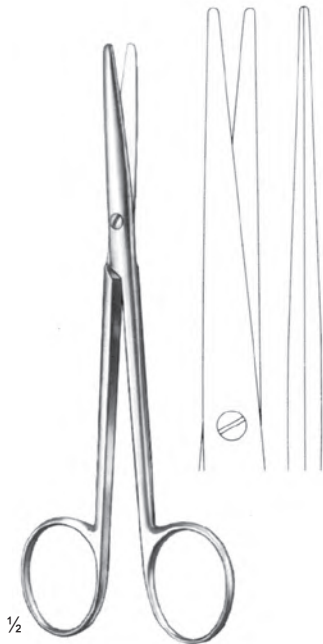

**LEXER-FINO**  
PC 04-1398-16  
16 cm/6 1/4"  
Straight

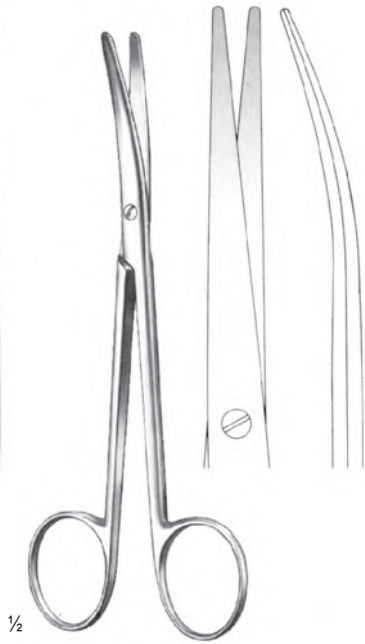

**LEXER-FINO**  
PC 04-1399-16  
16 cm/6 1/4"  
Curved

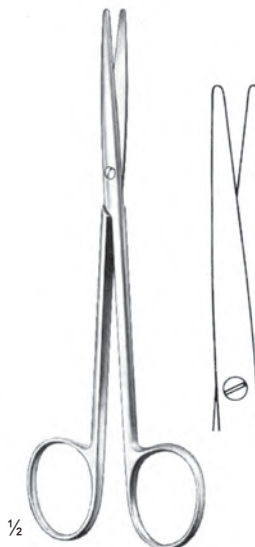

**METZENBAUM-FINO**  
PC 04-1400-14  
14.5 cm/5 3/4"  
Straight  
Blunt/Blunt

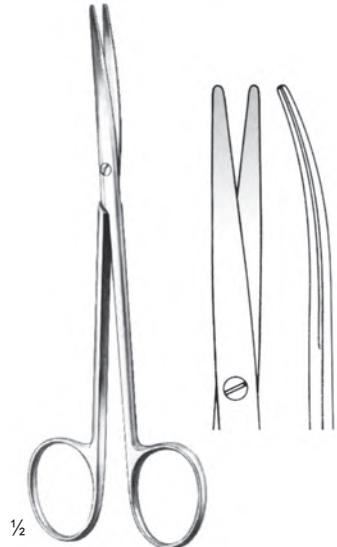

**METZENBAUM-FINO**  
PC 04-1401-14  
14.5 cm/5 3/4"  
Curved  
Blunt/Blunt

- EN —● Fine Dissecting Scissors
- DE —● Fine Präparierscheren
- ES —● Tijeras finas de disección



**METZENBAUM-FINO**  
 PC 04-1402-14  
 14.5 cm/5 3/4"  
 Straight  
 Sharp/Sharp

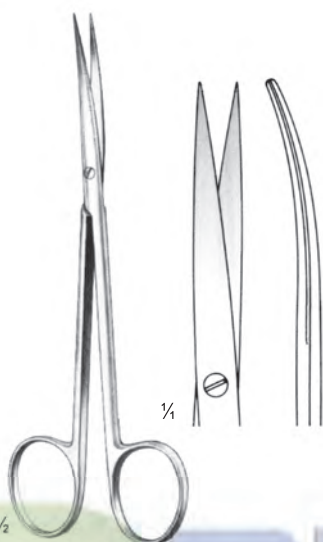

**METZENBAUM-FINO**  
 PC 04-1403-14  
 14.5 cm/5 3/4"  
 Curved  
 Sharp/Sharp

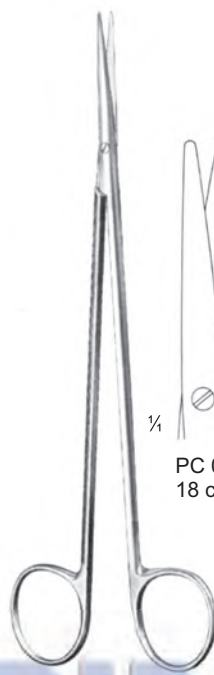

PC 04-1404-18  
 18 cm/7 1/8"



PC 04-1404-20  
 20 cm/7 7/8"



PC 04-1404-23  
 23 cm/9"

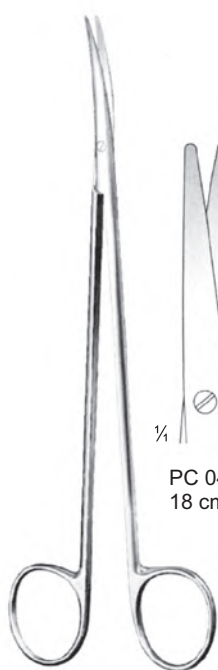

PC 04-1405-18  
 18 cm/7 1/8"



PC 04-1405-20  
 20 cm/7 7/8"



PC 04-1405-23  
 23 cm/9"



PC 04-1406-18  
 18 cm/7 1/8"



PC 04-1406-20  
 20 cm/7 7/8"



PC 04-1406-23  
 23 cm/9"

**METZENBAUM-FINO**

**METZENBAUM-FINO**  
 S-SHAPED



Ligature Scissors, Nail Splitting Scissors ● EN  
 Ligaturscheren, Nagelschere ● DE  
 Tijeras para ligaduras, Tijeras de uñas Splitting ● ES

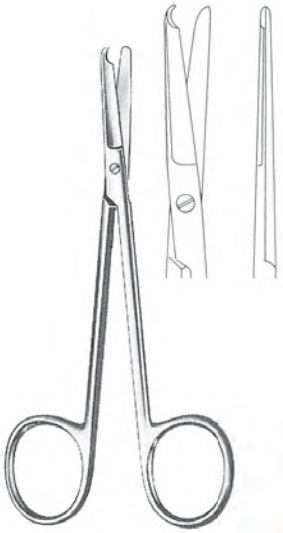

**SPENCER**  
 PC 04-1407-09 9 cm/3 1/2"  
 PC 04-1407-10 10.5 cm/4 1/8"  
 PC 04-1407-13 13 cm/5 1/8"

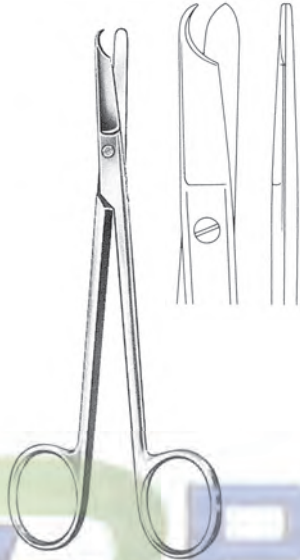

**LITTAUER**  
 PC 04-1408-14  
 14 cm/5 1/2"

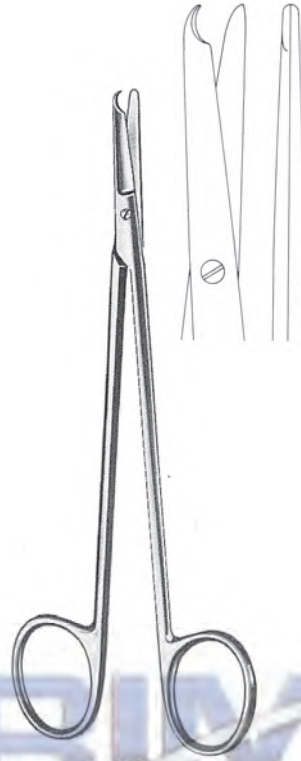

**BUCK**  
 PC 04-1409-14  
 14.5 cm/5 3/4"

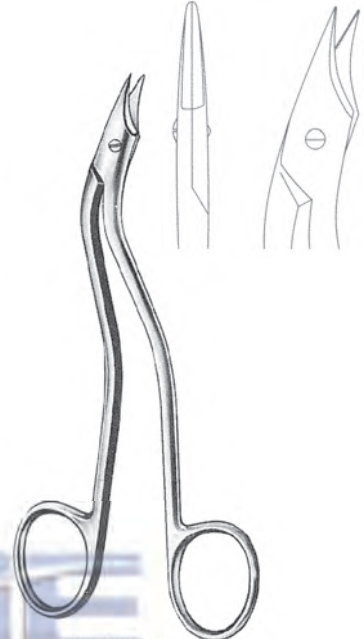

**HEATH**  
 PC 04-1410-15  
 15 cm/5 7/8"

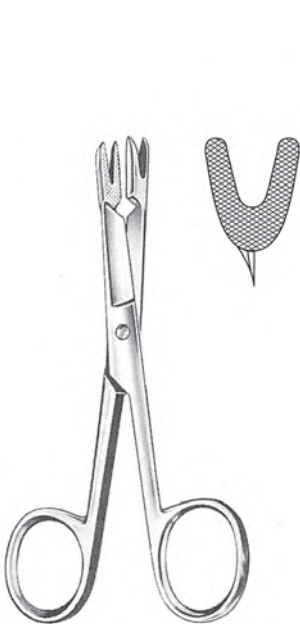

**SCHOEMAKER-LOTH**  
 PC 04-1411-13  
 13 cm/5 1/8"

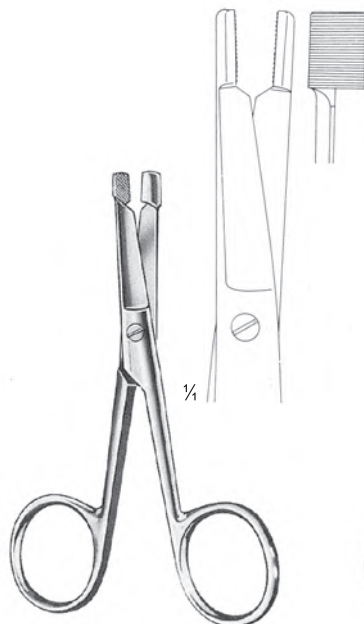

**EISELSBERG**  
 PC 04-1412-12  
 12 cm/4 3/4"



**NORTHBENT**  
 PC 04-1413-09 9 cm/3 1/2"  
 PC 04-1413-12 12.5 cm/4 7/8"

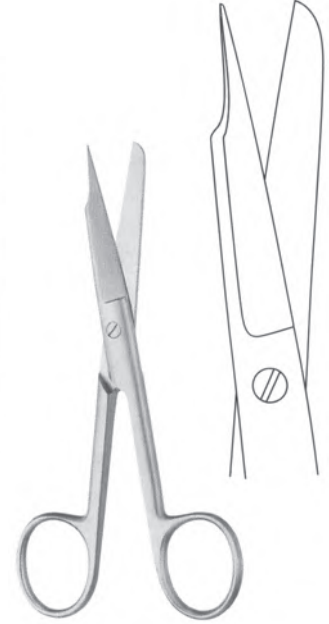

**NAIL SPLITTING SCISSORS**  
 PC 04-1414-13 13 cm/5 1/8"  
 PC 04-1414-15 15 cm/5 7/8"



- EN —● Dissecting Scissors, Face Lift Scissors
- DE —● Präparierscheren, Face-lift Scheren
- ES —● Tijeras de disección, Tijeras para Face-lift

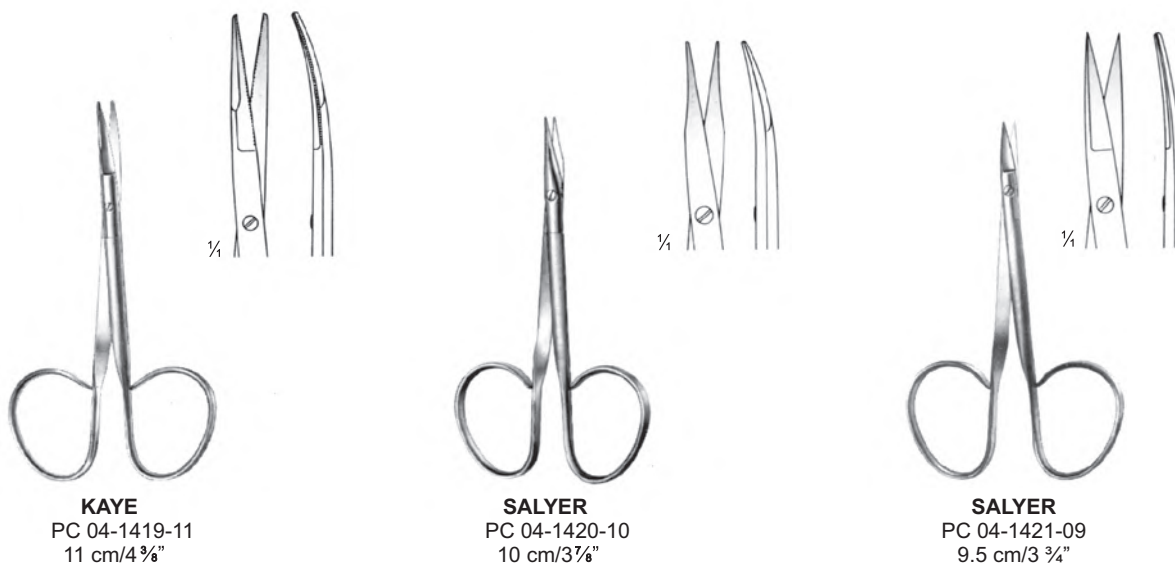
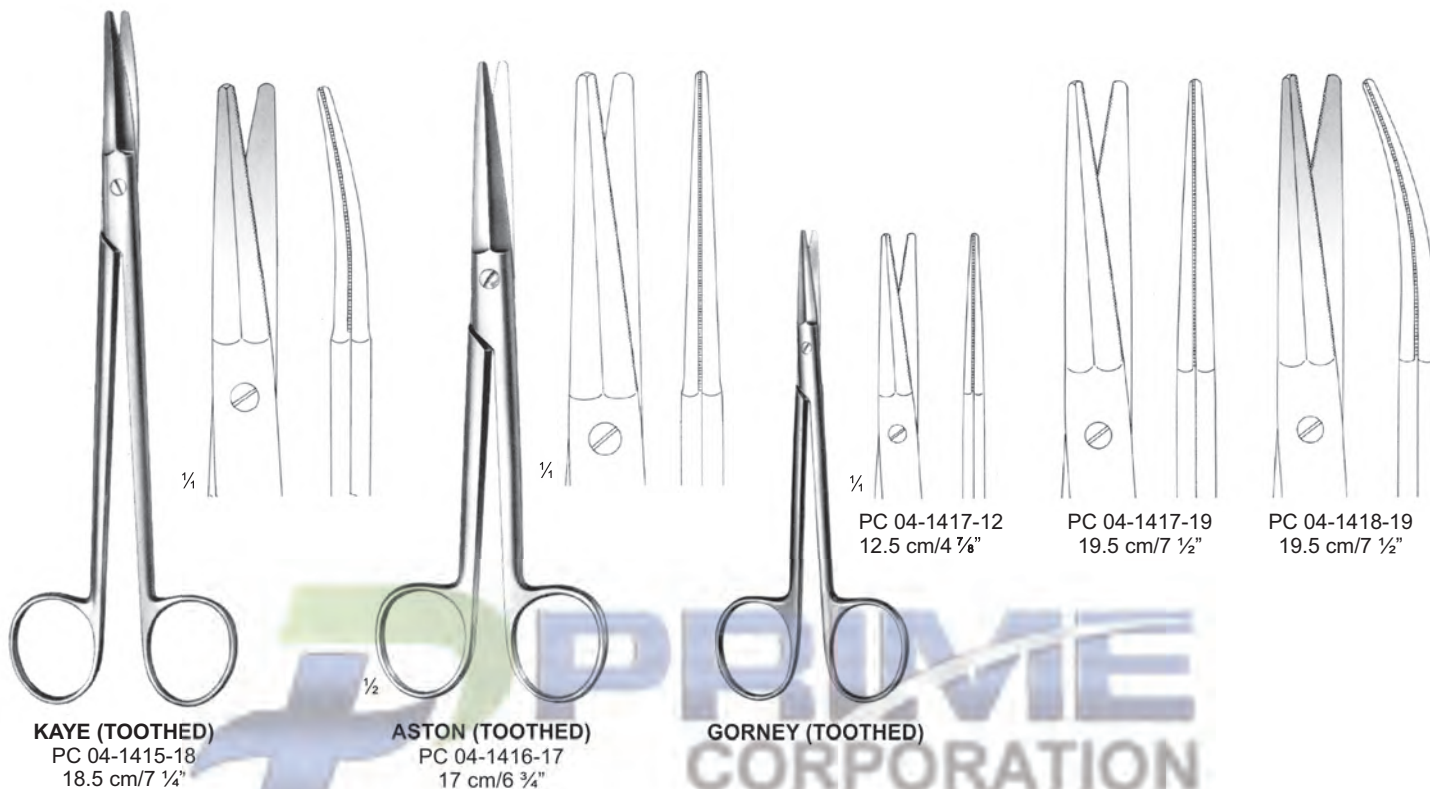

Eye Scissors, Fine Operating Scissors ●— EN  
 Augenschere, Fine Chirurgische Scheren ●— DE  
 Tijeras para eye, Tijeras finas quirúrgicas ●— ES

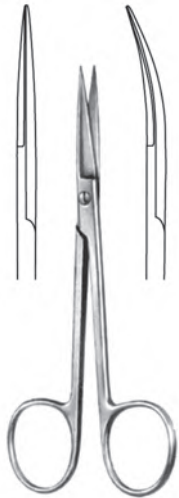

**IRIS**

Straight	Curved
PC 04-1422-09	PC 04-1423-09
PC 04-1422-10	PC 04-1423-10
PC 04-1422-11	PC 04-1423-11

9 cm/3 1/2"  
 10.5 cm/4 1/8"  
 11.5 cm/4 1/2"

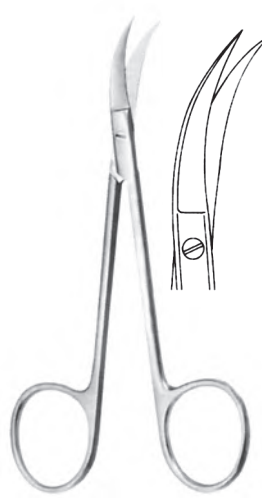

**IRIS-FINE**

PC 04-1424-11  
 11.5 cm/4 1/2"



**IRIS-FINE**

PC 04-1425-11  
 11.5 cm/4 1/2"  
 angled



**Pointed**



straight  
 PC 04-1426-11

**Blunt**



straight  
 PC 04-1428-11



**STEVENS-TENOTOMY**  
 11.5 cm/4 1/2"

curved  
 PC 04-1427-11

curved  
 PC 04-1429-11

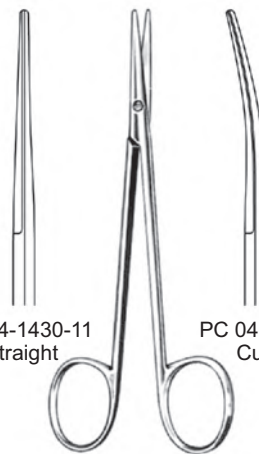

**STRABISMUS**  
 11.5 cm/4 1/2"

PC 04-1430-11  
 Straight

PC 04-1431-11  
 Curved

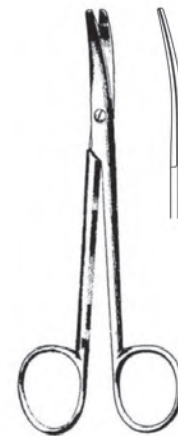

**ENUCLEATION**  
 PC 04-1432-11  
 11 cm/4 3/8"

- EN —● Wire Cutting Scissors, Ligature Scissors
- DE —● Drahtscheren, Ligaturscheren
- ES —● Tijeras para cortar hilos de acero, Tijeras para ligaduras

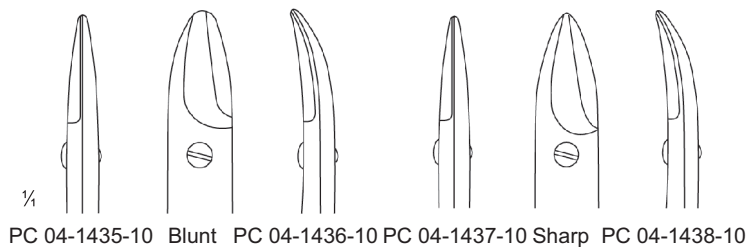

**UNIVERSAL**  
PC 04-1433-12  
12 cm/4 3/4"  
one saw edge

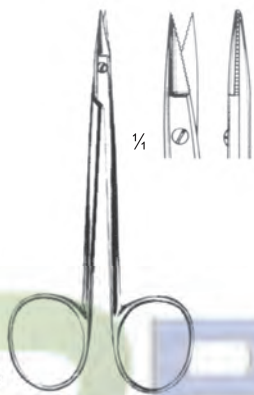

**BEEBEE**  
PC 04-1434-10  
10 cm/3 7/8"  
saw edge

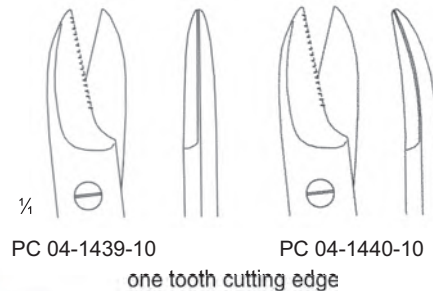

PC 04-1441-12  
12 cm/4 3/4"  
saw edge



PC 04-1442-10  
10.5 cm/4 1/8"  
saw edge



PC 04-1443-15  
15.5 cm/6 1/8"  
saw edge

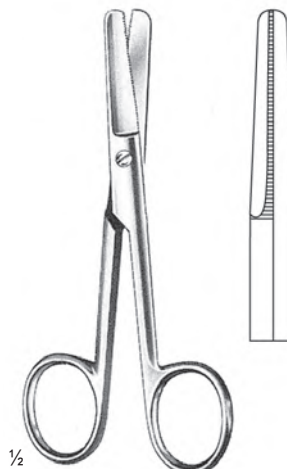

**HARVEY**  
PC 04-1444-12  
12.5 cm/4 7/8"

Fine Operating Scissors, Gum Scissors ●— EN  
 Fine Chirurgische Scheren, Zahnfleissscheren ●— DE  
 Tijeras finas quirúrgicas, Tijeras para cirugía y encías ●— ES

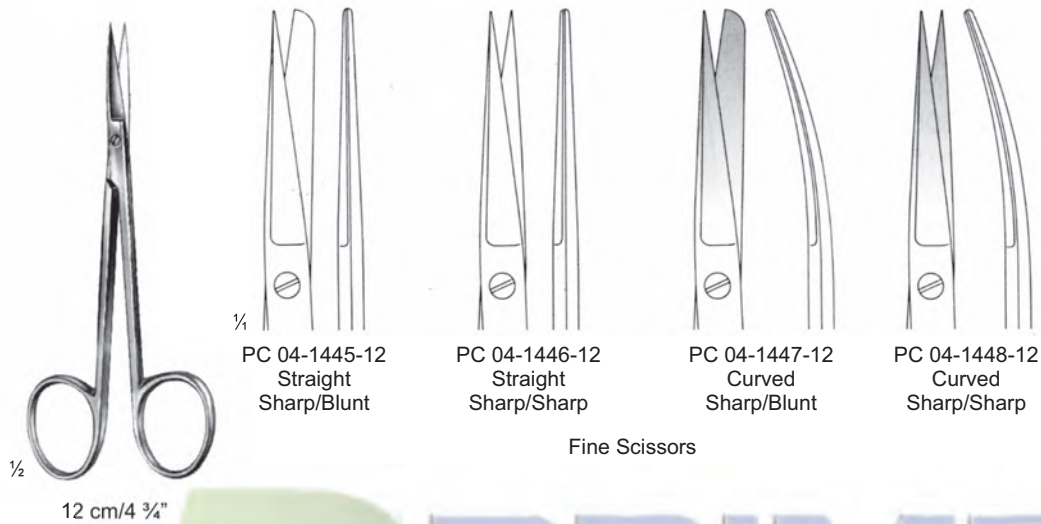

Fine Scissors

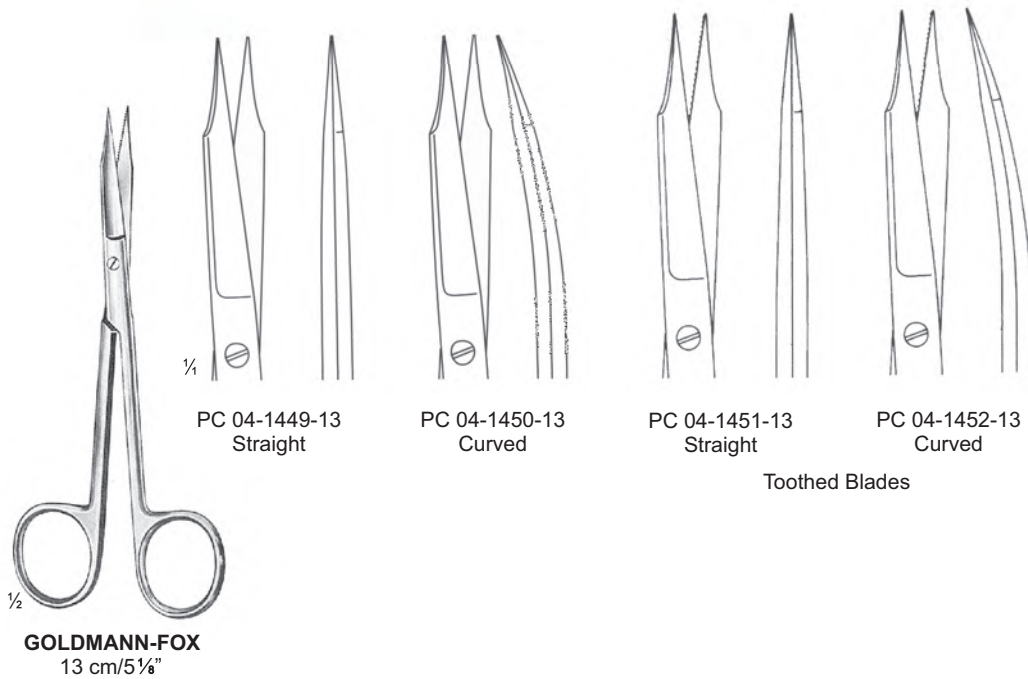

Toothed Blades



- EN —● Fine Operating Scissors & Gum Scissors
- DE —● Fine Chirurgische und Zahnfleischscheren
- ES —● Tijeras finas para cirugía y encías

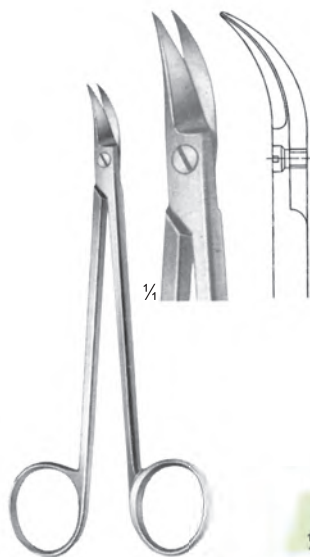

**QUINBY**  
PC 04-1453-12  
12.5 cm/4 7/8"



**NEUMANN**  
PC 04-1454-12  
12 cm/4 3/4"

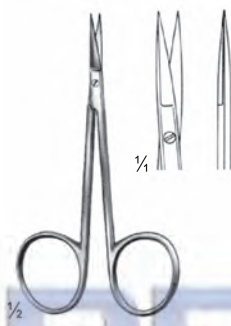

PC 04-1455-08  
8 cm/3 1/4"  
delicate

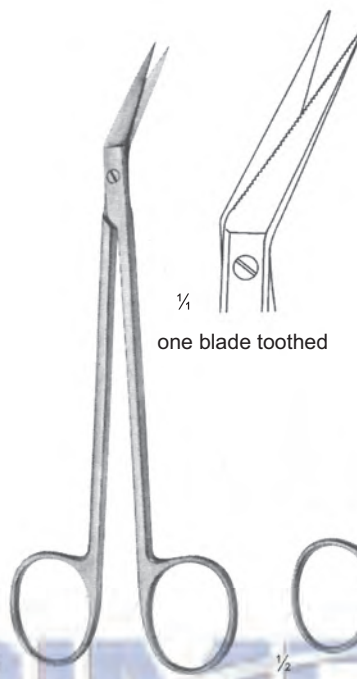

**LOCKLIN**  
PC 04-1456-16  
16 cm/6 1/4"

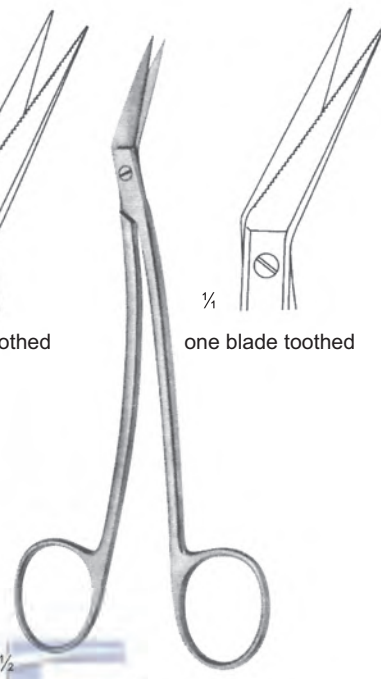

**LOCKLIN**  
PC 04-1457-16  
16 cm/6 1/4"

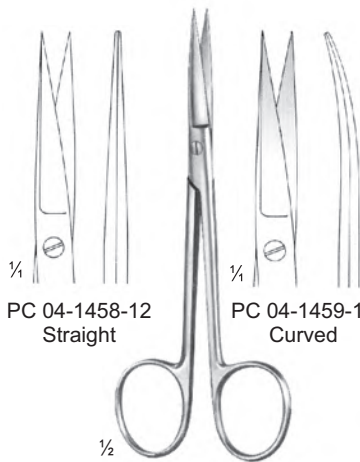

PC 04-1458-12  
Straight



**WAGNER**  
12 cm/4 3/4"

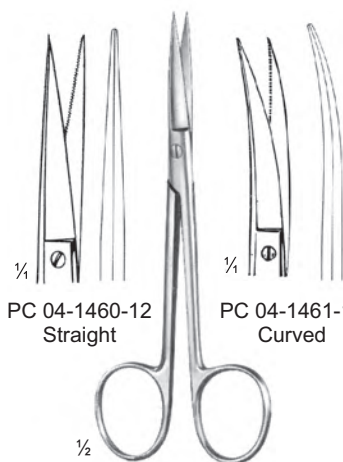

PC 04-1460-12  
Straight



**WAGNER**  
12 cm/4 3/4"  
Saw edge

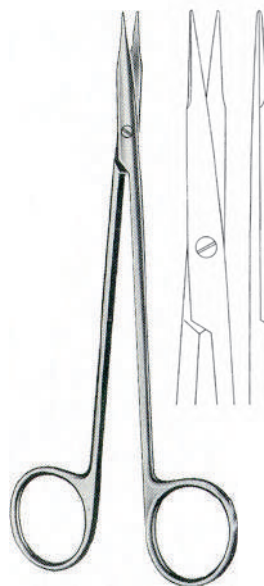

**REYNOLDS**  
Straight  
PC 04-1462-14 14.5 cm/5 3/4"  
PC 04-1462-15 15.5 cm/6 1/8"  
PC 04-1462-17 17.5 cm/6 7/8"  
PC 04-1462-18 18.0 cm/7 1/8"

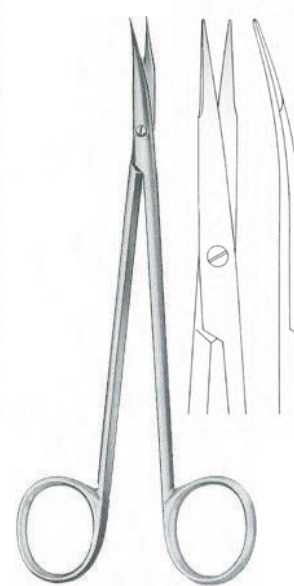

Curved  
PC 04-1463-14  
PC 04-1463-15  
PC 04-1463-17  
PC 04-1463-18

Umbilical Scissors, Fine Operating Scissors ● EN  
 Nabelschnurscheren, Fine Chirurgische Scheren ● DE  
 Tijeras umbilicales, Tijeras Finas para Cirugia ● ES



**SCHUMACHER**  
 PC 04-1464-16  
 16 cm/6 1/4"



**LANDOLT**  
 PC 04-1465-12  
 12.5 cm/4 7/8"



**LANDOLT**  
 PC 04-1466-12  
 12.5 cm/4 7/8"

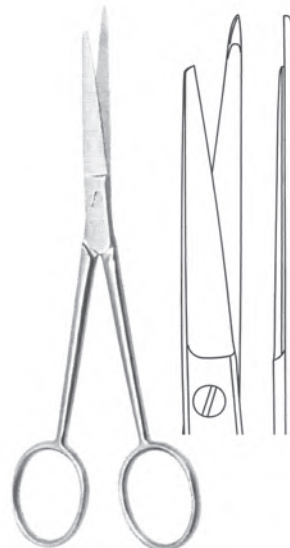

**PC 04-1467-14**  
 14.5 cm/5 3/4"

- EN —● Vascular Scissors, Coronary Scissors
- DE —● Gefäßscheren, Koronarscheren
- ES —● Tijeras vasculares, Tijeras coronarias



DIETRICH



25°  
PC 04-1468-19  
19 cm/7 1/2"



45°  
PC 04-1468-18  
18 cm/7 1/8"



60°  
PC 04-1468-17  
17.5 cm/6 7/8"



90°  
PC 04-1469-17  
17.5 cm/6 7/8"



125°  
PC 04-1470-17  
17.5 cm/6 7/8"



MICRO-HEGEMANN  
19 cm/7 1/2"



25°  
PC 04-1471-19



45°  
PC 04-1472-19



60°  
PC 04-1473-19



90°  
PC 04-1474-19



125°  
PC 04-1475-19

- Rectal Scissors ● EN
- Rektumschere ● DE
- Tijera para recto ● ES

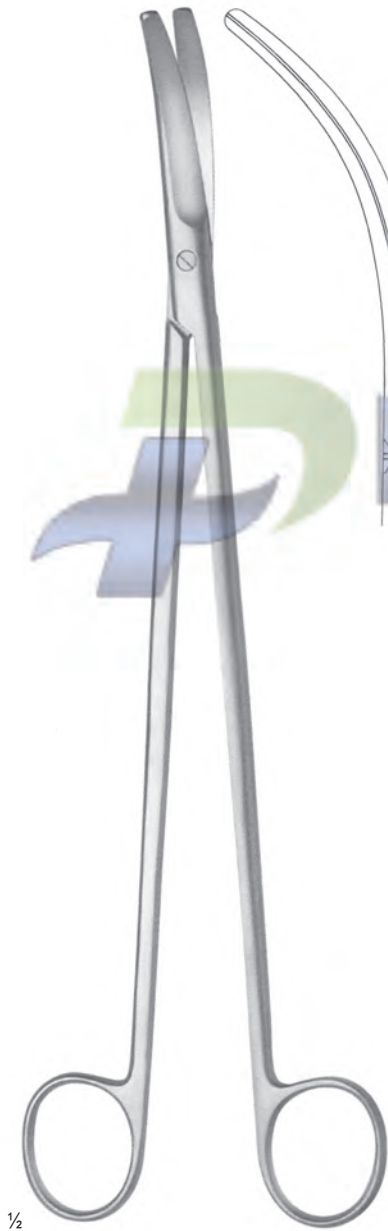

**RECTAL**  
PC 04-1476-32  
32.5 cm/12 3/4"



**FINOCHIETTO**  
PC 04-1477-27  
27 cm/10 1/2"



- EN —● Micro Scissors
- DE —● Mikroscheren
- ES —● Micro-Tijeras

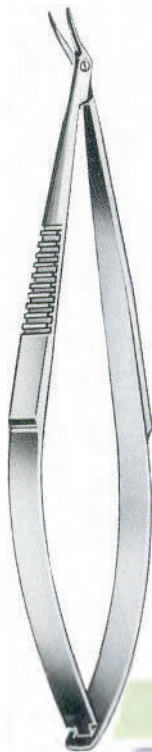

**TROUTMAN**  
PC 04-1478-10  
10 cm/4"

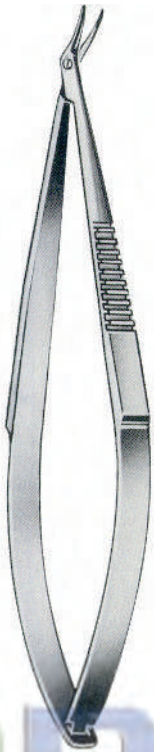

**TROUTMAN**  
PC 04-1479-10  
10 cm/4"

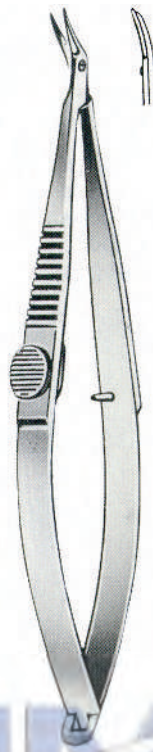

**KATZIN-BARRAQUER**  
PC 04-1480-10  
10 cm/4"

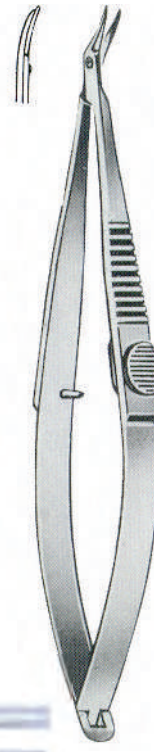

**KATZIN-BARRAQUER**  
PC 04-1481-10  
10 cm/4"

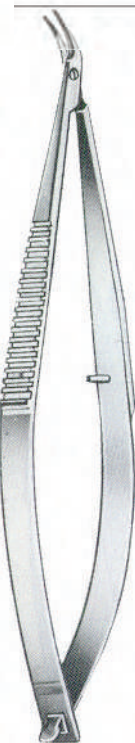

**KATZIN**  
PC 04-1482-10  
10 cm/4"

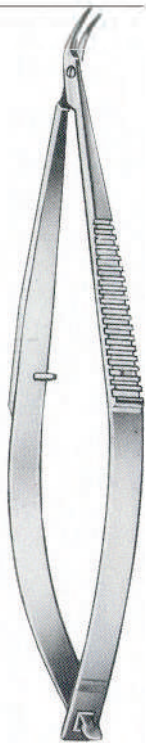

**KATZIN**  
PC 04-1483-10  
10 cm/4"

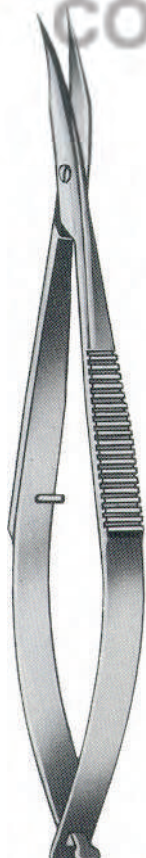

**WESTCOTT**  
PC 04-1484-11  
11 cm/4½"

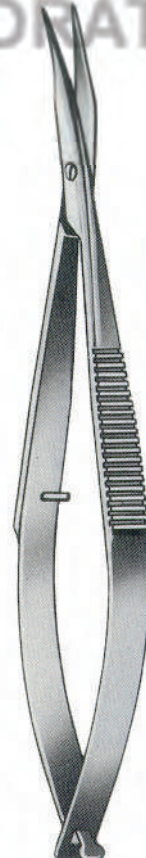

**WESTCOTT**  
PC 04-1485-11  
11 cm/4½"



**WESTCOTT**  
PC 04-1486-11  
11 cm/4½"

Micro Scissors ● EN  
 Mikroscheren ● DE  
 Micro-Tijeras ● ES

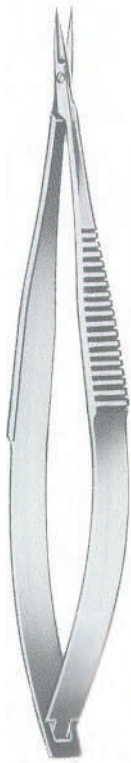

PC 04-1487-10  
10 cm/4"

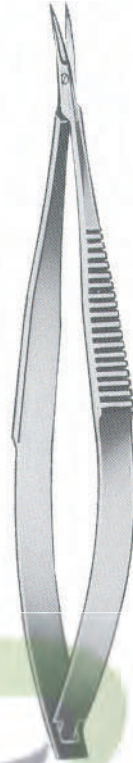

PC 04-1488-10  
10 cm/4"

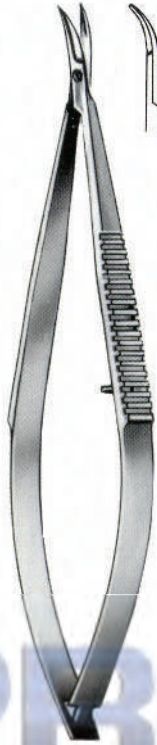

CASTROVIEJO  
PC 04-1489-10  
10 cm/4"

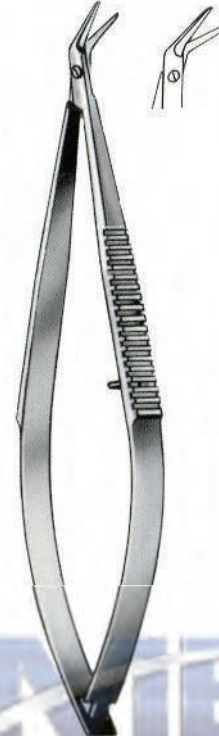

CASTROVIEJO  
PC 04-1490-10  
10 cm/4"



AEBLI  
PC 04-1491-10  
10 cm/4"

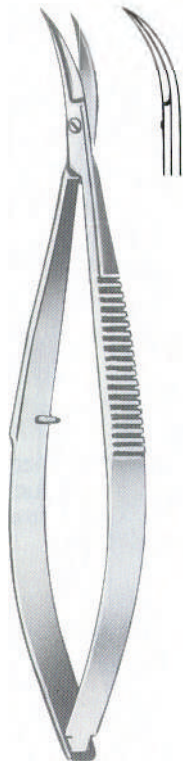

CASTROVIEJO  
PC 04-1492-10  
10 cm/4"

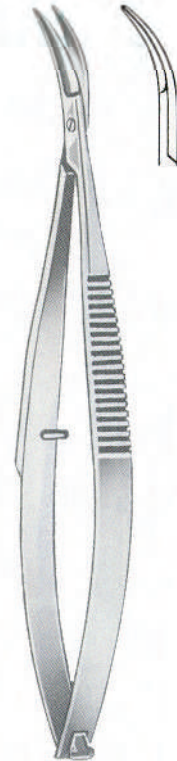

CASTROVIEJO  
PC 04-1493-10  
10 cm/4"

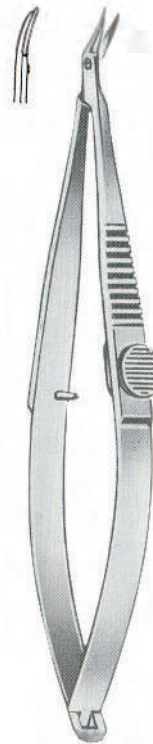

TROUTMAN-BARRAQUER  
PC 04-1494-10  
10 cm/4"

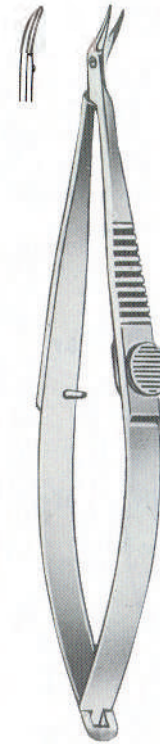

TROUTMAN-BARRAQUER  
PC 04-1495-10  
10 cm/4"



- EN —● Micro Scissors
- DE —● Mikroscheren
- ES —● Micro-Tijeras



**CASTROVIEJO**  
PC 04-1496-10  
10 cm/4"

**CASTROVIEJO**  
PC 04-1497-10  
10 cm/4"

**CASTROVIEJO**  
PC 04-1498-11  
11.5 cm/4½"

**CASTROVIEJO**  
PC 04-1499-11  
11.5 cm/4½"



**TROUTMANN-CASTROVIEJO**  
PC 04-1500-10  
10.5 cm/4¼"

**TROUTMANN-CASTROVIEJO**  
PC 04-1501-10  
10.5 cm/4¼"



14.5 cm/5¾"  
18.0 cm/7"

Straight  
PC 04-1502-14  
PC 04-1502-18

Curved  
PC 04-1503-14  
PC 04-1503-18

- Micro Scissors ● EN
- Mikroscheren ● DE
- Micro-Tijeras ● ES

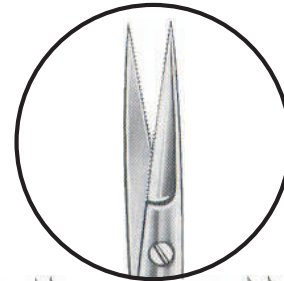

Saw Edge



Straight  
PC 04-1504-16  
16cm/6¼"

Curved  
PC 04-1505-16  
16cm/6¼"

Straight  
PC 04-1506-16  
16cm/6¼"

Curved  
PC 04-1507-16  
16cm/6¼"

**MILLESI**  
Straight  
PC 04-1508-16  
16cm/6¼"

**MILLESI**  
Curved  
PC 04-1509-16  
16cm/6¼"



- EN —● Micro Scissors  
 DE —● Mikroscheren  
 ES —● Micro-Tijeras

## Dissecting Scissors



Straight  
 PC 04-1510-14  
 14.5cm/5¾"



Curved  
 PC 04-1511-14  
 14.5cm/5¾"



Curved  
 PC 04-1512-14  
 14.5cm/5¾"

**EN** Super-Cut Scissors

**DE** Super-Cut Scheren

**ES** Tijeras Super-Cut

Page 65 to 74



- EN —●— Supercut Scissors
- DE —●— Supercut Scheren
- ES —●— Tijeras Supercut

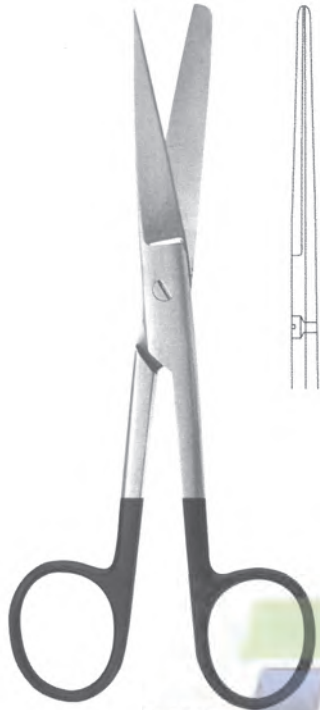

**STANDARD**  
PC 05-1601-14  
14.5 cm/5 ¾"

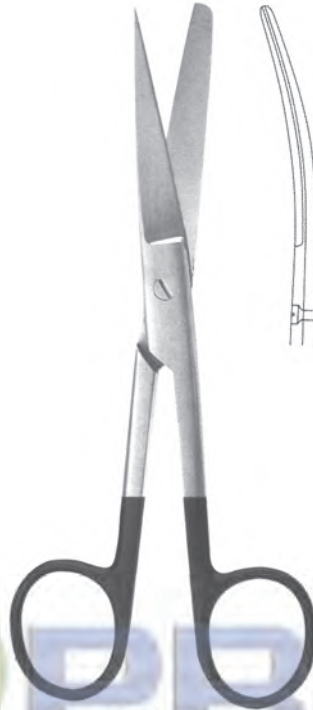

**STANDARD**  
PC 05-1602-14  
14.5 cm/5 ¾"

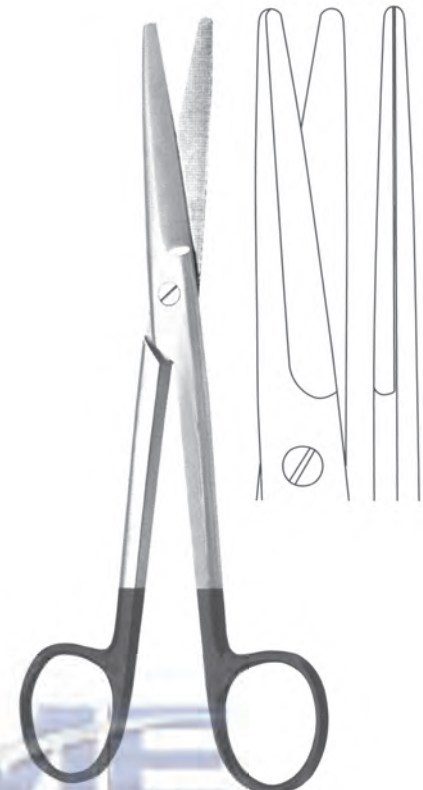

**MAYO**  
PC 05-1603-14 14.5 cm/5 ¾"  
PC 05-1603-17 17 cm/6 ¾"  
PC 05-1603-23 23 cm/9"

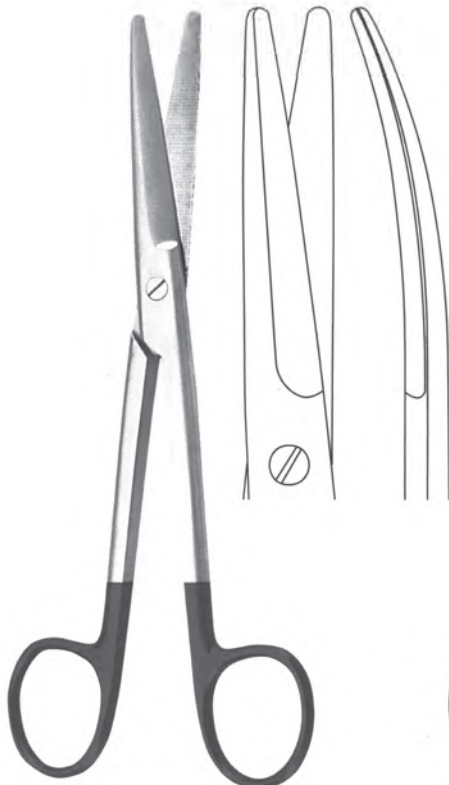

**MAYO**  
PC 05-1604-14 14.5 cm/5 ¾"  
PC 05-1604-17 17 cm/6 ¾"  
PC 05-1604-23 23 cm/9"

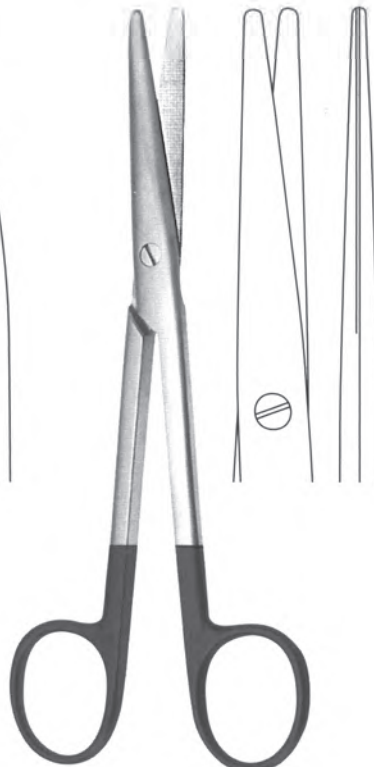

**MAYO-STILLE**  
PC 05-1605-15 15 cm/5 ⅞"  
PC 05-1605-17 17 cm/6 ¾"

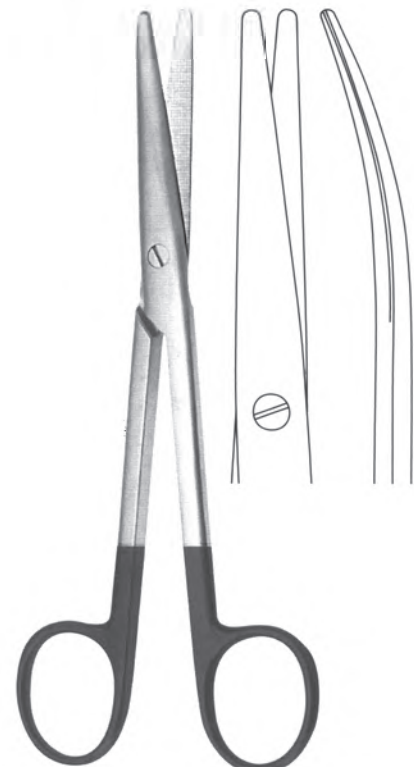

**MAYO-STILLE**  
PC 05-1606-16 15 cm/5 ⅞"  
PC 05-1606-17 17 cm/6 ¾"

Supercut Scissors ●— EN  
 Supercut Scheren ●— DE  
 Tijeras Supercut ●— ES

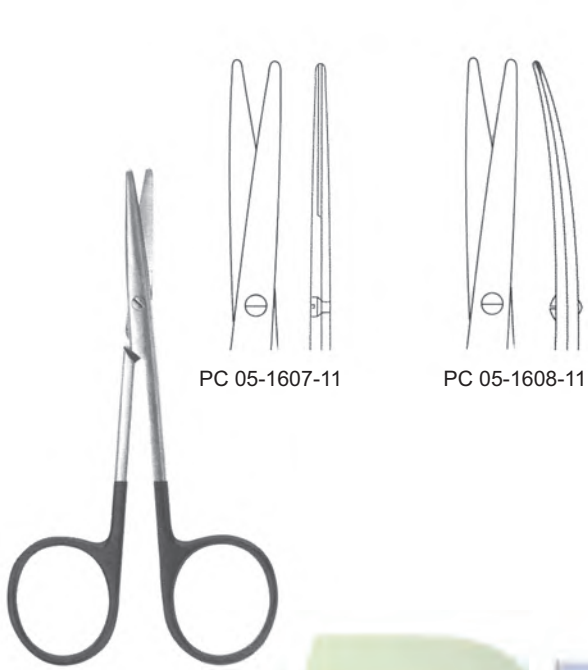

PC 05-1607-11

PC 05-1608-11

**METZENBAUM**  
 11.5 cm/4 1/2"

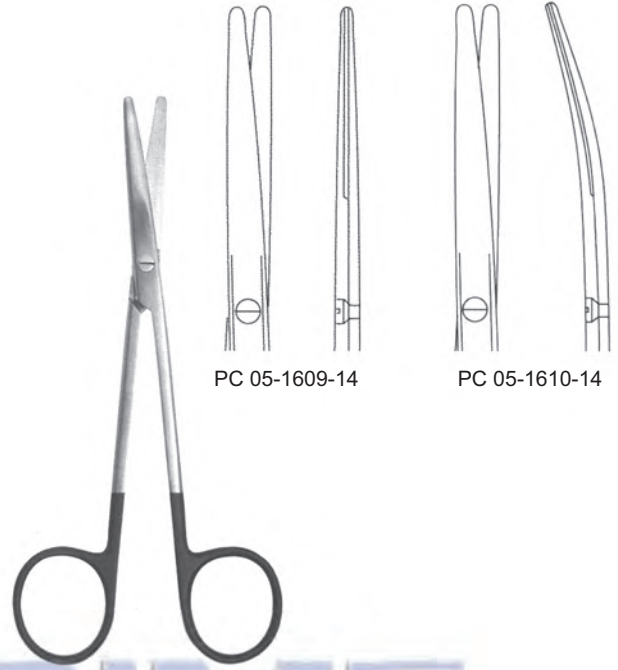

PC 05-1609-14

PC 05-1610-14

**METZENBAUM**  
 14.5 cm/5 3/4"



**METZENBAUM-NELSON**  
 PC 05-1611-18 18 cm/7 1/8"  
 PC 05-1611-20 20 cm/7 7/8"  
 PC 05-1611-23 23 cm/9"  
 PC 05-1611-26 26 cm/10 1/4"



**METZENBAUM-NELSON**  
 PC 05-1612-18 18 cm/7 1/8"  
 PC 05-1612-20 20 cm/7 7/8"  
 PC 05-1612-23 23 cm/9"  
 PC 05-1612-26 26 cm/10 1/4"



- EN —●— Supercut Scissors
- DE —●— Supercut Scheren
- ES —●— Tijeras Supercut



PC 05-1613-11

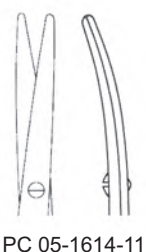

PC 05-1614-11

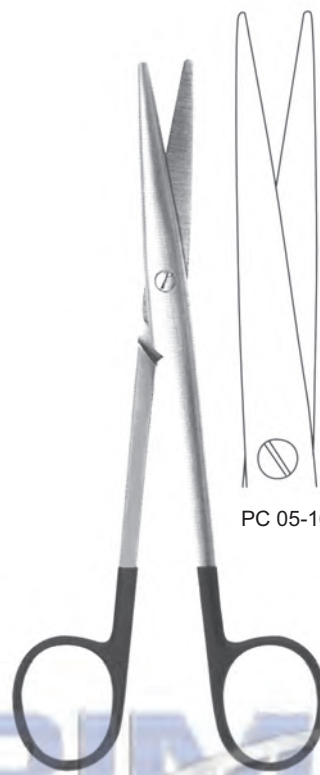

PC 05-1615-16

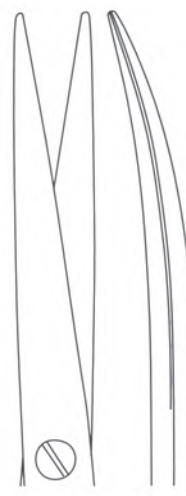

PC 05-1616-16

**STRABISMUS**  
11.5 cm/4 1/2"

**LEXER**  
16 cm/6 1/4"



PC 05-1617-14



PC 05-1618-14

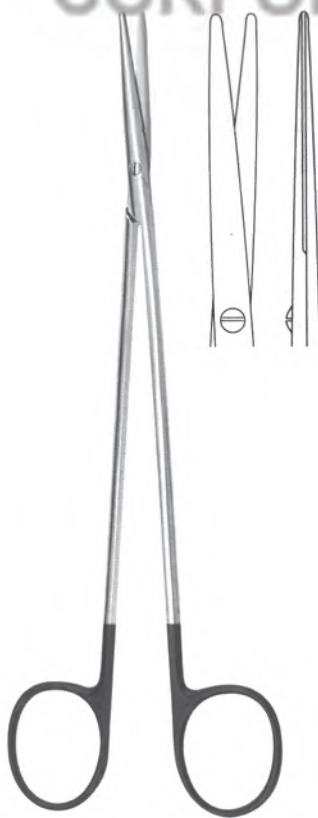

**METZENBAUM-FINO**  
PC 05-1619-18 18 cm/7 1/8"  
PC 05-1619-20 20 cm/7 7/8"  
PC 05-1619-23 23 cm/9"

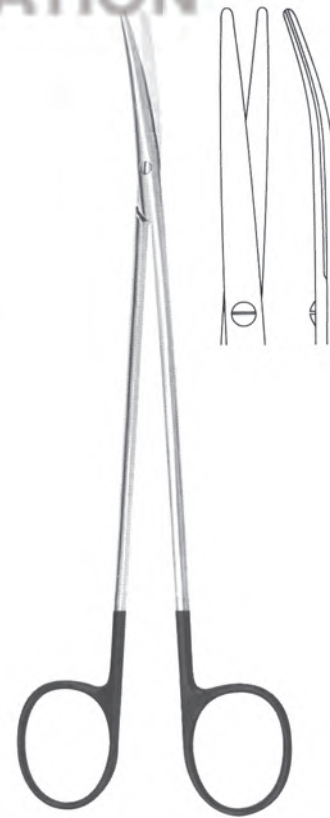

**METZENBAUM-FINO**  
PC 05-1620-18 18 cm/7 1/8"  
PC 05-1620-20 20 cm/7 7/8"  
PC 05-1620-23 23 cm/9"

**METZENBAUM-FINO**  
14.5 cm/5 3/4"

- Supercut Scissors ● EN
- Supercut Scheren ● DE
- Tijeras Supercut ● ES



**TOENNIS-ADSON**  
PC 05-1621-17  
17.5 cm/6 7/8"

**SIMS**  
PC 05-1622-20  
20 cm/7 7/8"

**SIMS**  
PC 05-1623-20 20 cm/7 7/8"  
PC 05-1623-23 23 cm/9"



**SIEBOLD**  
PC 05-1624-24  
24 cm/9 1/2"



**WALDMANN**  
PC 05-1625-18  
18 cm/7 1/8"

Episiotomy scissors



PC 05-1626-20  
20 cm/7 7/8"

- EN —● Supercut Scissors
- DE —● Supercut Scheren
- ES —● Tijeras Supercut



**FOMON**  
PC 05-1627-13  
13.5 cm/5 3/8"



**FOMON**  
PC 05-1628-14  
14.5 cm/5 3/4"



**COTTLE**  
PC 05-1629-16  
16 cm/6 1/4"



**HEYMANN**  
PC 05-1630-18  
18 cm/7 1/8"



- Supercut Scissors ● EN
- Supercut Scheren ● DE
- Tijeras Supercut ● ES



PC 05-1631-19

PC 05-1632-19

PC 05-1633-19

**POTTS-SMITH**  
19 cm/7 1/2"

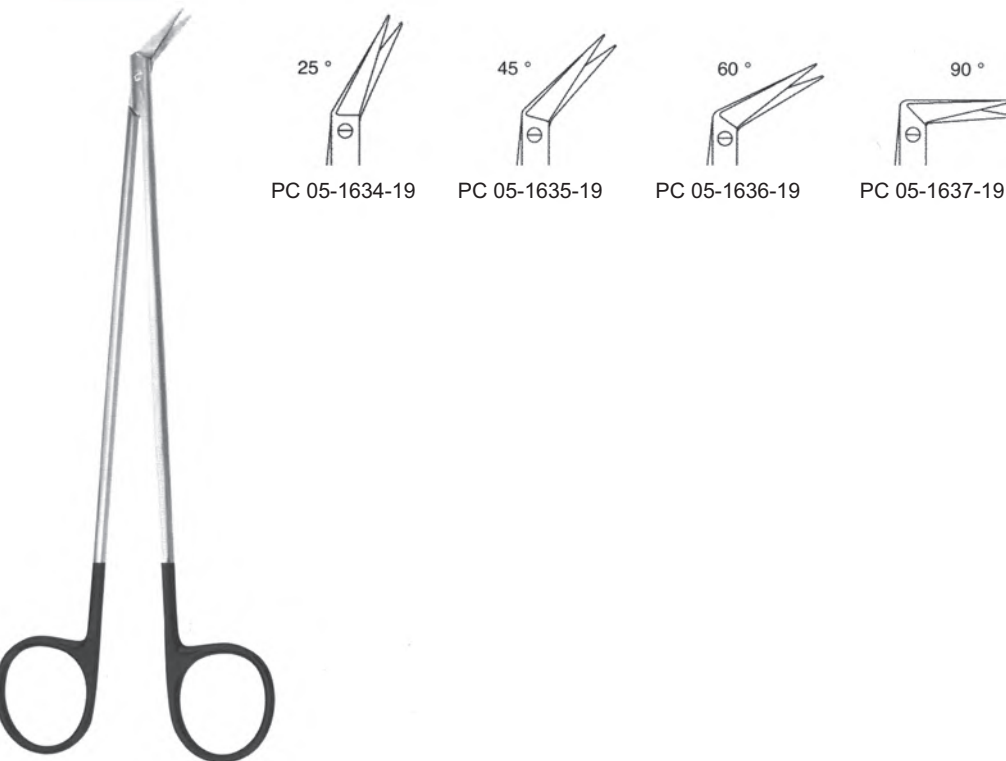

PC 05-1634-19

PC 05-1635-19

PC 05-1636-19

PC 05-1637-19

**DIETRICH**  
19 cm/7 1/2"



- EN —●— Supercut Scissors
- DE —●— Supercut Scheren
- ES —●— Tijeras Supercut



PC 05-1638-16

Fistula scissors

**KELLY**  
16 cm/6 1/4"



PC 05-1639-16

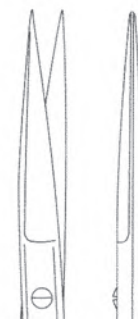

PC 05-1640-14



**JOSEPH**  
14 cm/5 1/2"



PC 05-1641-14



PC 05-1642-11

**IRIS**  
11.5 cm/4 1/2"

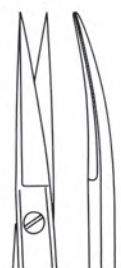

PC 05-1643-11



PC 05-1644-12



**WAGNER**  
12 cm/4 3/4"



PC 05-1645-12

- Supercut Scissors ● EN
- Supercut Scheren ● DE
- Tijeras Supercut ● ES



**STEVENS**  
11.5 cm/4 1/2"

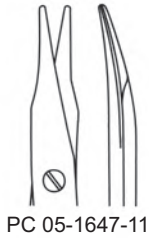
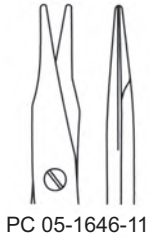

**GOLDMANN-FOX**  
13 cm/5 1/8"

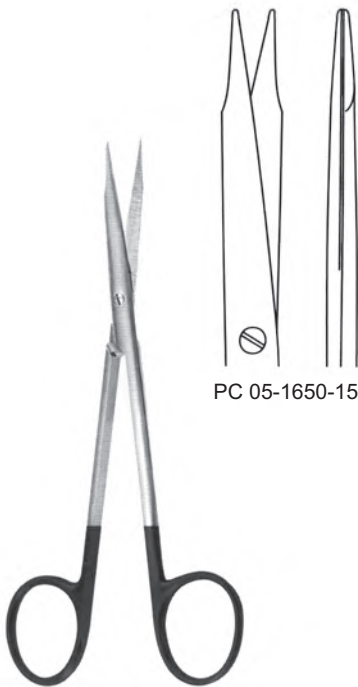
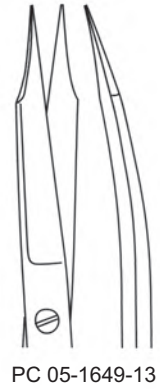
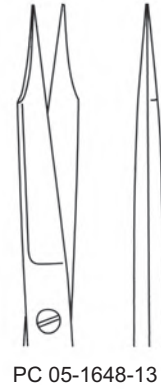

**REYNOLDS**  
15 cm/5 7/8"

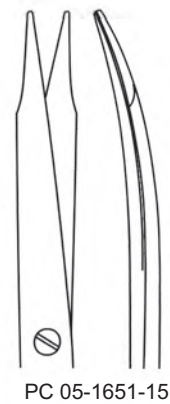
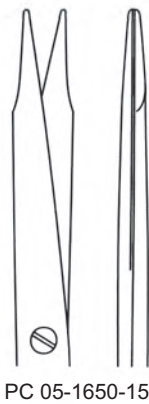

**REYNOLDS**  
PC 05-1652-17  
17.5 cm/6 7/8"

- EN —●— Supercut Scissors
- DE —●— Supercut Scheren
- ES —●— Tijeras Supercut



**JAMESON**  
PC 05-1653-15  
15 cm/5 7/8"



**PAR-TYPE**  
12 cm/4 3/4"

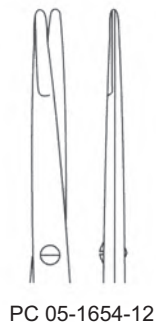

**KAYE FACE LIFT**  
PC 05-1656-15 15 cm/5 7/8"  
PC 05-1657-19 19 cm/7 1/2"

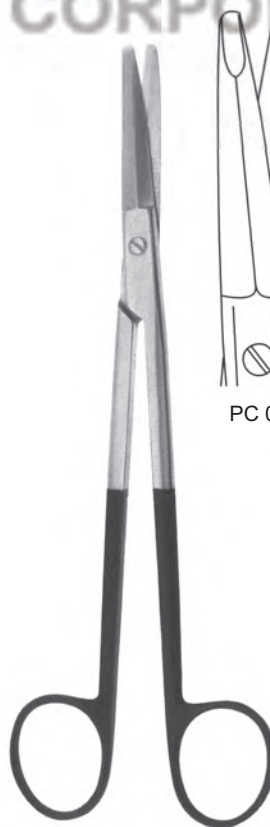

**GORNEY**  
19 cm/7 1/2"

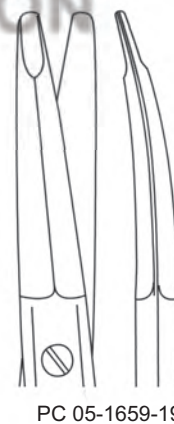
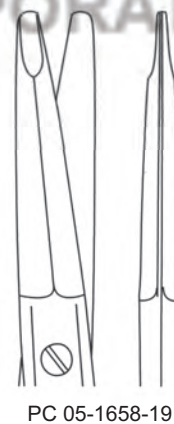

Supercut Scissors ●— EN  
 Supercut Scheren ●— DE  
 Tijeras Supercut ●— ES

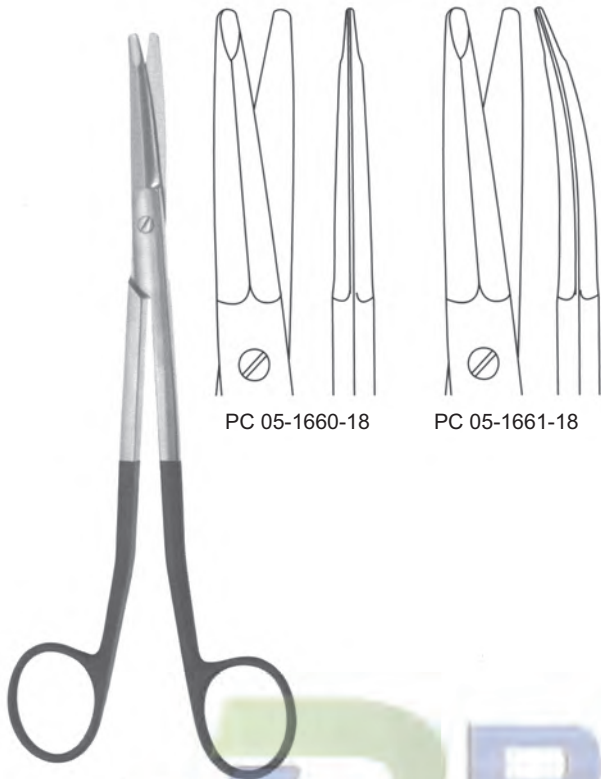

PC 05-1660-18

PC 05-1661-18

**FREEMANN-KAYE**  
18 cm/7 1/8"

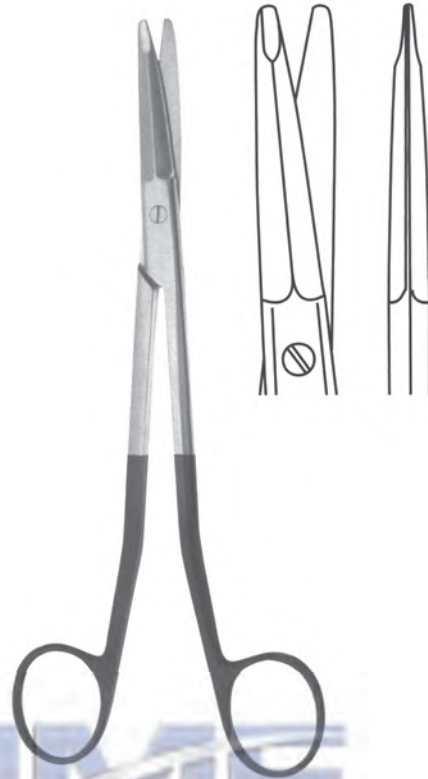

**FREEMANN-KAYE**  
PC 05-1662-19 19 cm/7 1/2"  
PC 05-1662-23 23 cm/9"

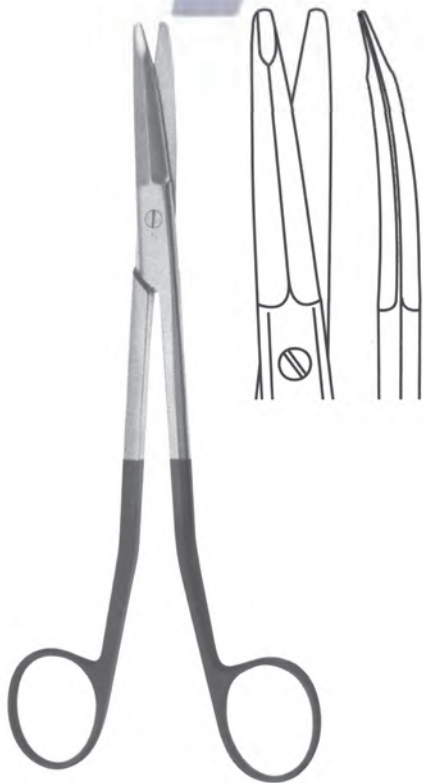

**FREEMANN-GORNEY**  
PC 05-1663-19 19 cm/7 1/2"  
PC 05-1663-23 23 cm/9"



**LISTER**  
PC 05-1664-14 14 cm/5 1/2"  
PC 05-1664-18 18 cm/7 1/8"  
PC 05-1664-20 20 cm/7 7/8"



**EN** TC Scissors

**DE** TC Scheren

**ES** Tijeras TC

Page 75 to 84

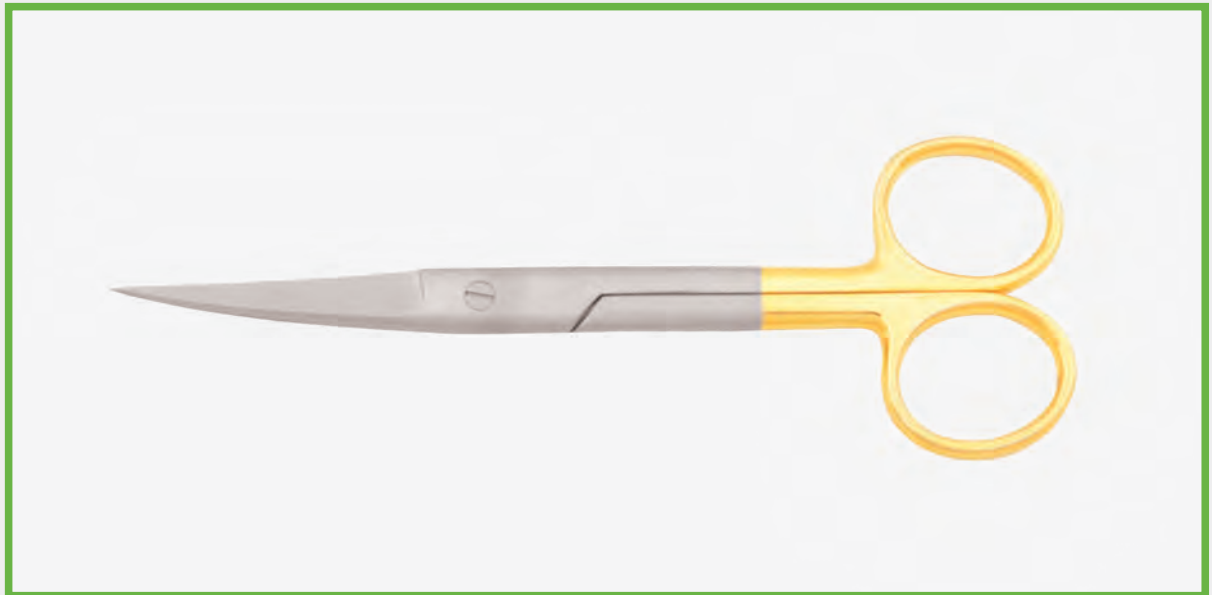

- EN —●— Operating Scissors
- DE —●— Chirurgische Scheren
- ES —●— Tijeras quirúrgicas

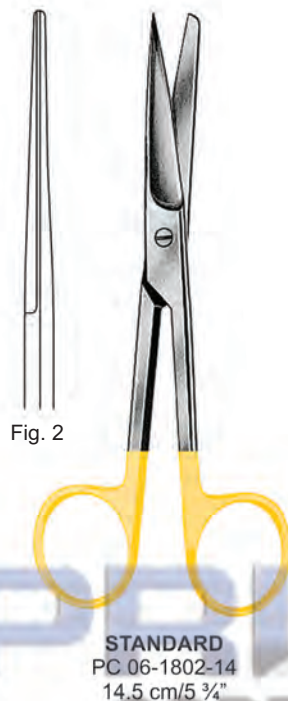
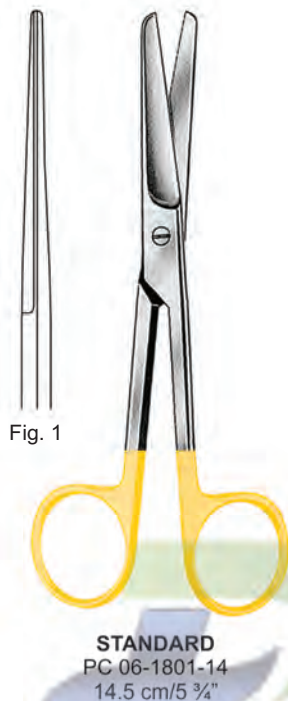



- EN —● Dissecting and Delicate Dissecting Scissors
- DE —● Präparierscheren und Feine Präparierscheren
- ES —● Tijeras de disección y finas de disección

PC 06-1815-11      PC 06-1816-11      PC 06-1817-14      PC 06-1818-14

**METZENBAUM**  
11.5 cm/4 1/2"

**METZENBAUM**  
14.5 cm/5 3/4"

Straight		Curved	
PC 06-1819-18	18 cm/7 1/8"	PC 06-1820-18	
PC 06-1819-20	20 cm/7 7/8"	PC 06-1820-20	
PC 06-1819-23	23 cm/9"	PC 06-1820-23	
PC 06-1819-25	25 cm/9 3/4"	PC 06-1820-25	
PC 06-1819-28	28 cm/11"	PC 06-1820-28	
PC 06-1819-30	30 cm/11 3/4"	PC 06-1820-30	

**METZENBAUM-Fino**  
PC 06-1821-14  
14.5 cm/5 3/4"

**METZENBAUM-Fino**  
PC 06-1822-14  
14.5 cm/5 3/4"

**METZENBAUM-Fino**  
PC 06-1823-14  
14.5 cm/5 3/4"

**METZENBAUM-Fino**  
PC 06-1824-14  
14.5 cm/5 3/4"



Delicate Dissecting Scissors ● EN  
 Feine Präparierscheren ● DE  
 Tijeras finas de disección ● ES



**METZENBAUM-Fino**  
 PC 06-1825-18 18 cm/7<sup>1</sup>/<sub>8</sub>"  
 PC 06-1825-20 20 cm/7<sup>7</sup>/<sub>8</sub>"  
 PC 06-1825-23 23 cm/9"  
 PC 06-1825-25 25 cm/9<sup>5</sup>/<sub>8</sub>"  
 PC 06-1825-28 28 cm/11"



**METZENBAUM-Fino**  
 PC 06-1826-18 18 cm/7<sup>1</sup>/<sub>8</sub>"  
 PC 06-1826-20 20 cm/7<sup>7</sup>/<sub>8</sub>"  
 PC 06-1826-23 23 cm/9"  
 PC 06-1826-25 25 cm/9<sup>5</sup>/<sub>8</sub>"  
 PC 06-1826-28 28 cm/11"



**METZENBAUM-Fino**  
 PC 06-1827-18 18 cm/7<sup>1</sup>/<sub>8</sub>"  
 PC 06-1827-20 20 cm/7<sup>7</sup>/<sub>8</sub>"  
 PC 06-1827-23 23 cm/9"  
 PC 06-1827-25 25 cm/9<sup>5</sup>/<sub>8</sub>"  
 PC 06-1827-28 28 cm/11"



**METZENBAUM-Fino**  
 PC 06-1828-18 18 cm/7<sup>1</sup>/<sub>8</sub>"  
 PC 06-1828-20 20 cm/7<sup>7</sup>/<sub>8</sub>"  
 PC 06-1828-23 23 cm/9"  
 PC 06-1828-25 25 cm/9<sup>5</sup>/<sub>8</sub>"  
 PC 06-1828-28 28 cm/11"



**TOENNIS-ADSON**  
 PC 06-1829-17  
 17.5 cm/6 <sup>7</sup>/<sub>8</sub>"

SUPER-Fino

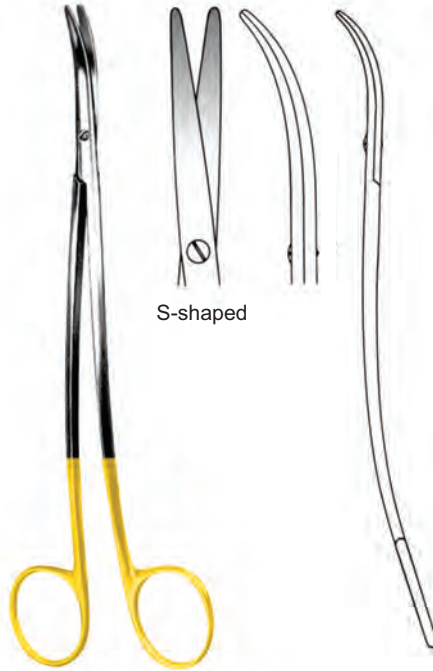

**METZENBAUM-Fino**  
 PC 06-1830-18 18 cm/7<sup>1</sup>/<sub>8</sub>"  
 PC 06-1830-20 20 cm/7<sup>7</sup>/<sub>8</sub>"  
 PC 06-1830-23 23 cm/9"

S-shaped

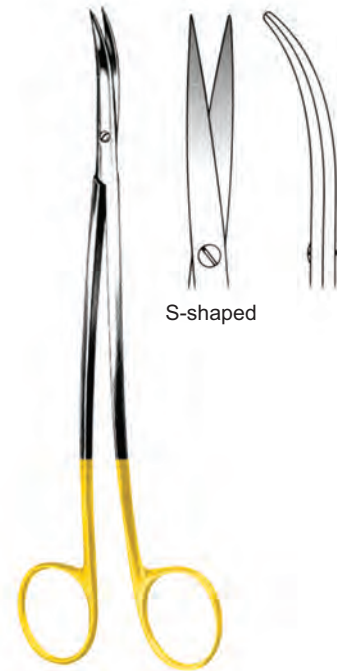

**METZENBAUM-Fino**  
 PC 06-1831-18 18 cm/7<sup>1</sup>/<sub>8</sub>"  
 PC 06-1831-20 20 cm/7<sup>7</sup>/<sub>8</sub>"  
 PC 06-1831-23 23 cm/9"

S-shaped

- EN —● Ligature Scissors, Wire Cutting Scissors
- DE —● Ligaturscheren, Drahtscheren
- ES —● Tijeras para ligaduras, Tijeras para cortar hilos de acero

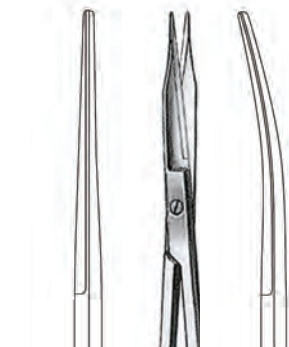

PC 06-1832-13



**GOLDMAN-FOX**  
13 cm/5 1/8"

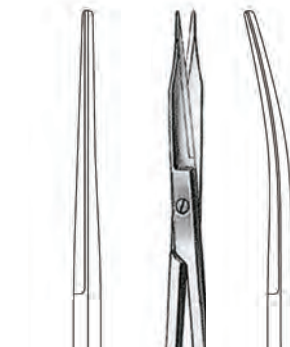

PC 06-1833-13



**GOLDMAN-FOX**  
Toothed blades  
13 cm/5 1/8"



PC 06-1834-13

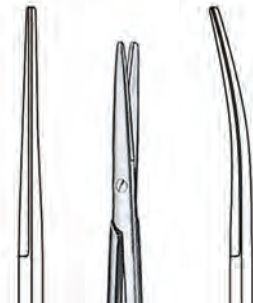

PC 06-1836-10



**KNAPP/LEXER-Baby**  
Starbismus  
10 cm/3 7/8"



PC 06-1837-10

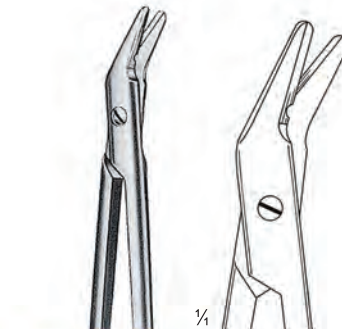

**UNIVERSAL (Wire Cutting)**  
PC 06-1838-12  
12 cm/4 3/4"



PC 06-1839-11



**IRIS**  
11.5 cm/4 1/2"



PC 06-1840-11



**BEEBEE**



PC 06-1841-11  
11 cm/4 1/2"  
Sharp

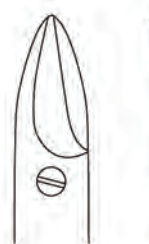

PC 06-1842-11  
11 cm/4 1/2"  
Sharp



PC 06-1843-10  
10 cm/3 7/8"  
Blunt

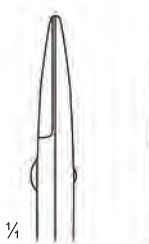

PC 06-1844-10  
10 cm/3 7/8"  
Blunt



PC 06-1845-11  
11 cm/4 3/8"  
Sharp

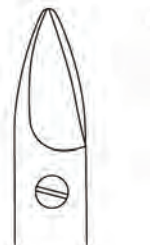

PC 06-1846-11  
11 cm/4 3/8"  
1 Blade serrated

Operating Scissors, Dissecting Scissors ●— EN  
 Chirurgische Scheren, Präparierscheren ●— DE  
 Tijeras quirúrgicas, Tijeras para preparaciones ●— ES



**KELLY**  
 PC 06-1847-16 16 cm/6 ¼"  
 PC 06-1847-18 18 cm/7 ⅛"



**KELLY**  
 PC 06-1848-16 16 cm/6 ¼"  
 PC 06-1848-18 18 cm/7 ⅛"



**RAGNELL**  
 PC 06-1849-12  
 12 cm/4 ¾"



**RAGNELL**  
 PC 06-1850-12  
 12 cm/4 ¾"



- EN —● Vascular and Fine Scissors
- DE —● Gefäßscheren und Feine scheren
- ES —● Tijeras para vasculares y finas

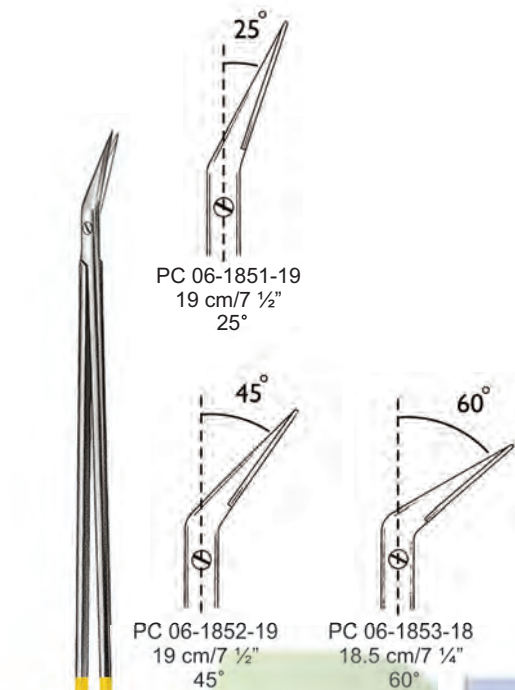

POTTS-SMITH



WAGNER  
PC 06-1854-11  
11.5 cm/4 1/2"



DEBAKEY

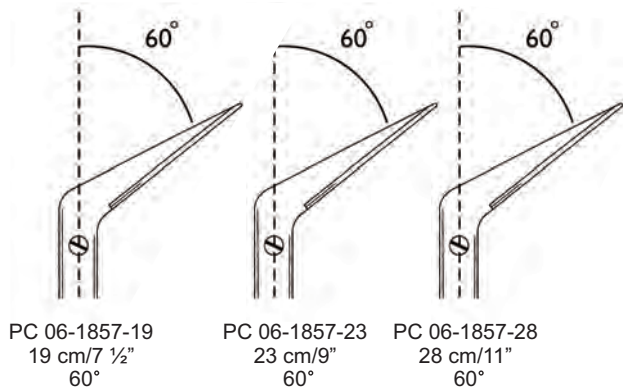
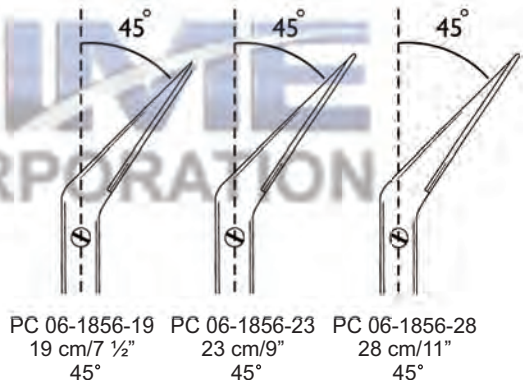
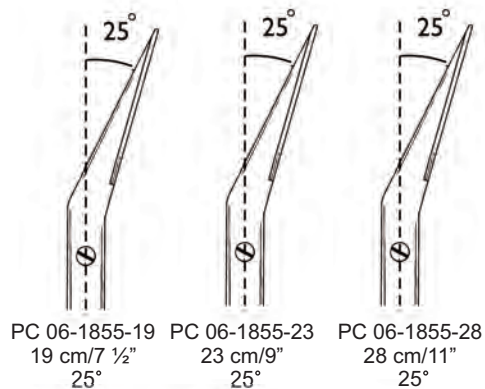



Bandage Scissors, Uterine Scissors ● EN  
 Verbandschere, Uterusschere ● DE  
 Tijeras para vendajes, Tijeras uterinas ● ES

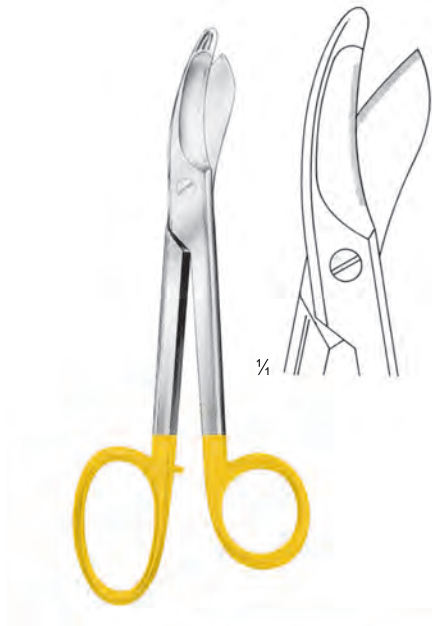

**BRUNS-Plaster**  
 PC 06-1858-24  
 24 cm/9 1/2"

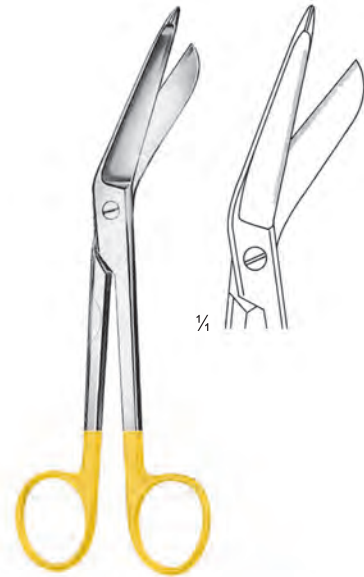

**LISTER-Bandage**  
 PC 06-1859-18  
 18 cm/7 1/8"

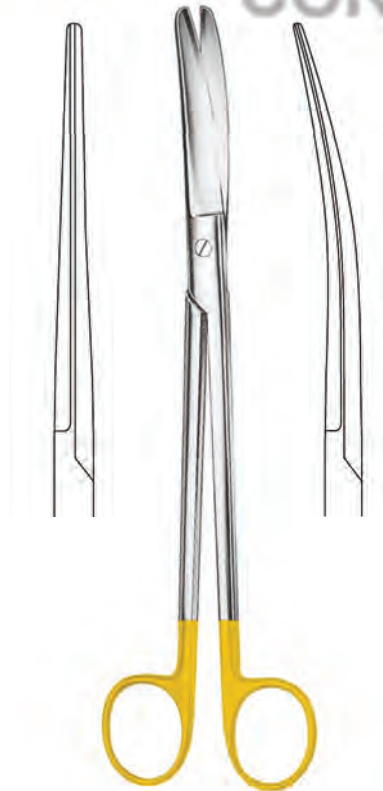

**SIMS (Uterine)**  
 PC 06-1860-20 20 cm/7 7/8" PC 06-1861-20  
 PC 06-1860-23 23 cm/9" PC 06-1861-23

- EN —● Micro Scissors
- DE —● Mikroscheren
- ES —● Micro Tijeras



PC 06-1862-16  
16 cm/6 1/4"

PC 06-1863-16  
16 cm/6 1/4"

Operating Scissors, Gynecological Scissors, Iris Scissors ● EN  
 Chirurgische Scheren, Gynäkologische Scheren, Irisscheren ● DE  
 Tijeras para ginecología, Tijeras para iridectomía ● ES

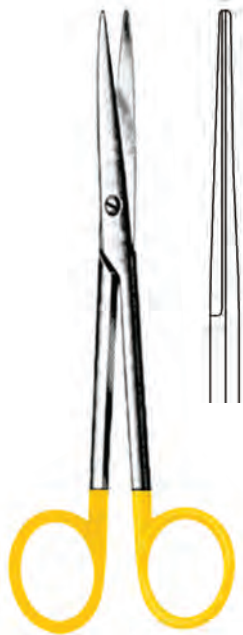

**LEXER**  
 PC 06-1864-16 16 cm/6 1/4"  
 PC 06-1864-21 21 cm/8 1/4"

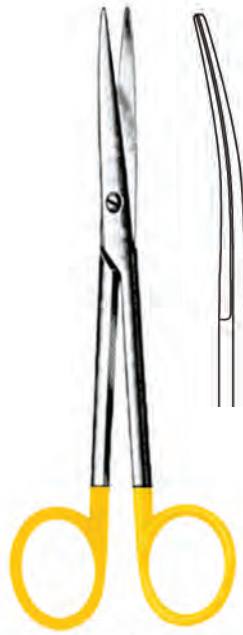

**LEXER**  
 PC 06-1865-16 16 cm/6 1/4"  
 PC 06-1865-21 21 cm/8 1/4"



**PARAMETRIUM**  
 PC 06-1866-22 22.5 cm/8 3/4"  
 PC 06-1866-23 23 cm/9"



**WERTHEIM**  
 PC 06-1867-22  
 22.5 cm/8 3/4"

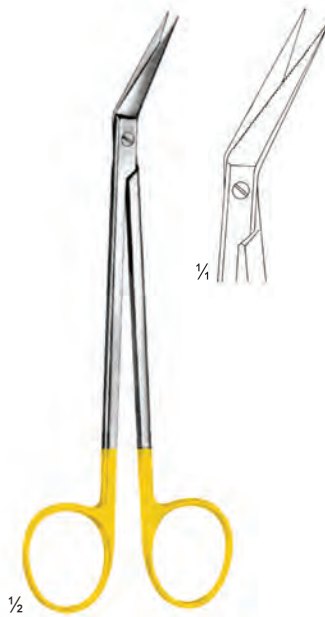

**LOCKLIN**  
 PC 06-1868-16  
 16 cm/6 1/4"  
 1 toothed blade



**LOCKLIN**  
 PC 06-1869-16  
 16 cm/6 1/4"  
 1 toothed blade

- EN** TC Super-Cut Scissors
- DE** TC Super-Cut Scheren
- ES** Tijeras Super-Cut TC

Page 85 to 86

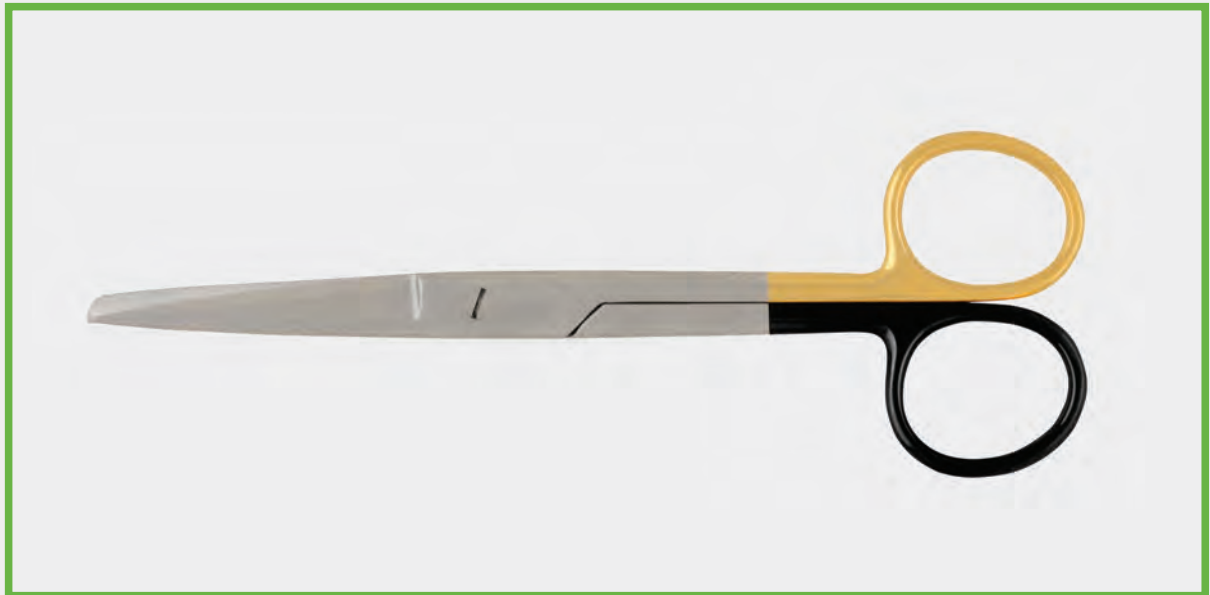



- EN —● Ligature Scissors
- DE —● Ligaturscheren
- ES —● Tijeras para ligaduras

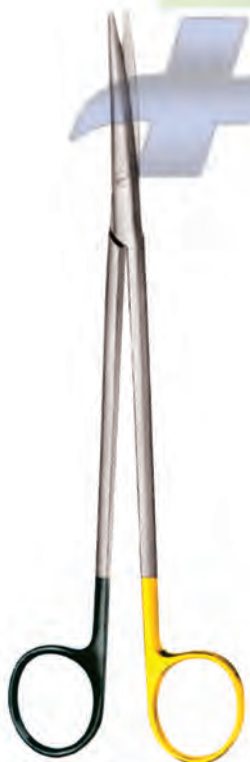

For synthetic suture material  
one toothed cutting edge

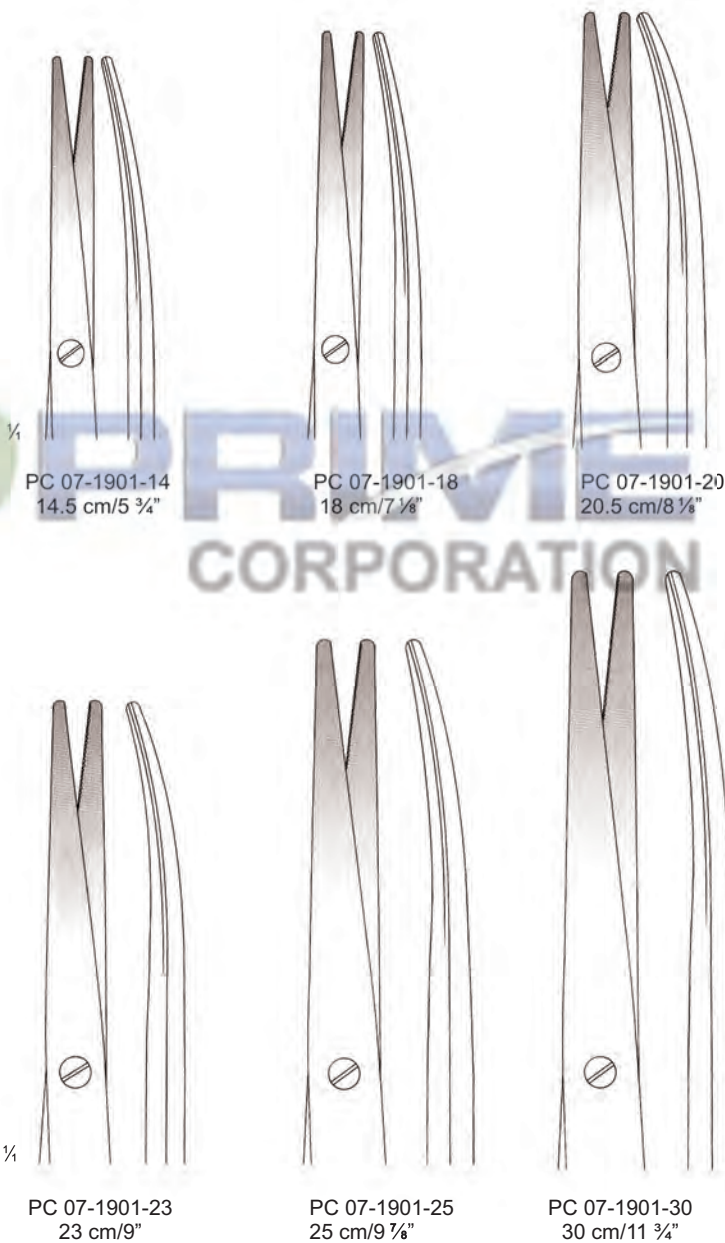

- Ligature Scissors ● EN
- Ligaturscheren ● DE
- Tijeras para ligaduras ● ES

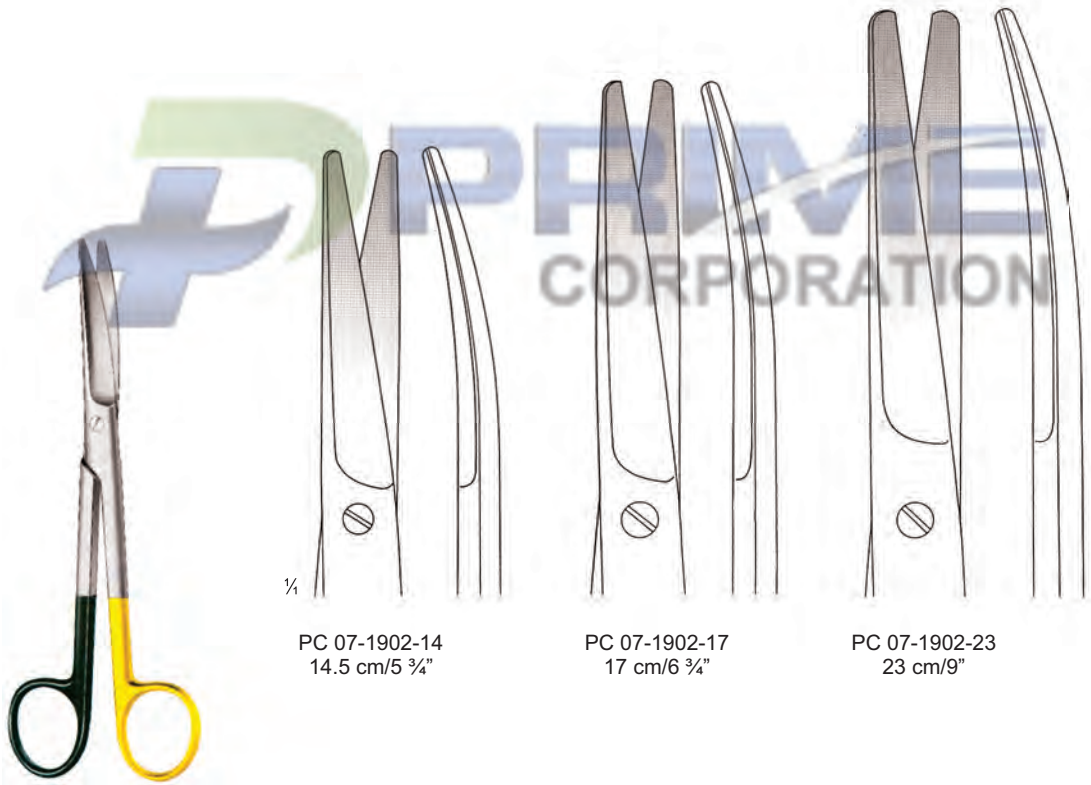

PC 07-1902-14  
14.5 cm/5 3/4"

PC 07-1902-17  
17 cm/6 3/4"

PC 07-1902-23  
23 cm/9"

For synthetic suture material  
one toothed cutting edge

**EN** Dressing & Tissue Forceps

**DE** Anatomische und Chirurgische Pinzetten

**ES** Pinzas de diseccion con dientes

Page 87 to 110



- EN —● Dissecting Forceps
- DE —● Anatomische Pinzetten
- ES —● Pinzas de disección



PC 08-2006-15  
15 cm/5 7/8"  
PC 08-2007-15  
15.5 cm/6 1/8"  
1 x 2

U.S.A. MODEL		GRACILE		ADSON		McINDOE	
PC 08-2001-12	12 cm/4 3/4"	PC 08-2002-12	12 cm/4 3/4"	PC 08-2003-12	12 cm/4 3/4"	PC 08-2004-15	15 cm/5 7/8"
PC 08-2001-13	13 cm/5 1/8"	PC 08-2002-13	13 cm/5 1/8"	PC 08-2003-15	15 cm/5 7/8"	PC 08-2005-15	15.5 cm/6 1/8"
PC 08-2001-14	14 cm/5 1/2"	PC 08-2002-14	14 cm/5 1/2"				
PC 08-2001-15	15 cm/5 7/8"	PC 08-2002-15	15 cm/5 7/8"				
PC 08-2001-18	18 cm/7 1/8"						
PC 08-2001-21	21 cm/8 1/4"						
PC 08-2001-23	23 cm/9"						
PC 08-2001-25	25 cm/9 7/8"						
PC 08-2001-31	31 cm/12 1/4"						



SEMKEN

PC 08-2008-12 12.5 cm/4 7/8"  
PC 08-2008-15 15 cm/5 7/8"  
PC 08-2008-18 18 cm/7 1/8"



SEMKEN

PC 08-2009-12 12.5 cm/4 7/8"  
PC 08-2009-15 15 cm/5 7/8"  
PC 08-2009-18 18 cm/7 1/8"

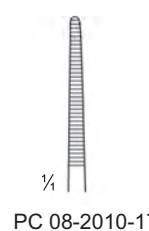

PC 08-2010-17



PC 08-2011-17



TAYLOR

17.5 cm/6 7/8"



Dissecting Forceps — EN  
 Anatomische Pinzetten — DE  
 Pinzas de disección — ES



**STANDARD**  
(Narrow Pattern)

- PC 08-2012-11 11.5 cm/4 1/2"
- PC 08-2012-13 13 cm/5 1/8"
- PC 08-2012-14 14 cm/5 1/2"
- PC 08-2012-16 16 cm/6 1/4"
- PC 08-2012-18 18 cm/7 1/8"
- PC 08-2012-20 20 cm/7 7/8"
- PC 08-2012-23 23 cm/9"
- PC 08-2012-25 25 cm/9 7/8"
- PC 08-2012-30 30 cm/11 3/4"



**STANDARD**  
(Straight)

- PC 08-2013-13 13 cm/5 1/8"
- PC 08-2013-14 14 cm/5 1/2"
- PC 08-2013-16 16 cm/6 1/4"
- PC 08-2014-10 10.5 cm/4 1/8"
- PC 08-2014-11 11.5 cm/4 1/2"
- PC 08-2014-13 13 cm/5 1/8"
- PC 08-2014-14 14 cm/5 1/2"
- PC 08-2014-16 16 cm/6 1/4"
- PC 08-2014-18 18 cm/7 1/8"
- PC 08-2014-20 20 cm/7 7/8"
- PC 08-2014-23 23 cm/9"
- PC 08-2014-25 25 cm/9 7/8"
- PC 08-2014-30 30 cm/11 3/4"



**STANDARD**  
(Curved)

- PC 08-2015-11 11.5 cm/4 1/2"
- PC 08-2015-13 13 cm/5 1/8"
- PC 08-2015-14 14 cm/5 1/2"
- PC 08-2015-16 16 cm/6 1/4"
- PC 08-2015-18 18 cm/7 1/8"
- PC 08-2015-20 20 cm/7 7/8"
- PC 08-2015-23 23 cm/9"

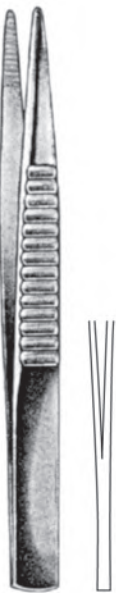

**ENGL. MODELL**

- PC 08-2016-12 12.5 cm/4 7/8"
- PC 08-2016-15 15.5 cm/6 1/8"



**ENGL. MODELL**

- PC 08-2017-13 13 cm/5 1/8"
- PC 08-2017-14 14.5 cm/5 3/4"



**STANDARD**

- PC 08-2018-13 13 cm/5 1/8"
- PC 08-2018-14 14 cm/5 1/2"



**STILLE**

- PC 08-2019-15 15 cm/5 7/8"

- EN —● Dissecting Forceps
- DE —● Anatomische Pinzetten
- ES —● Pinzas de disección

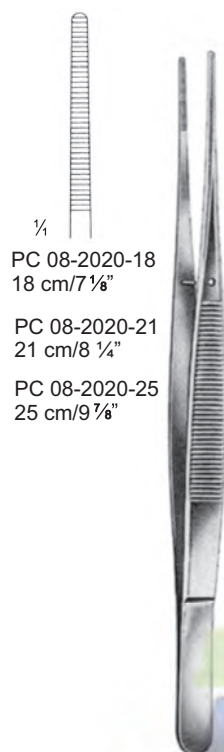

PC 08-2020-18  
18 cm/7 1/8"

PC 08-2020-21  
21 cm/8 1/4"

PC 08-2020-25  
25 cm/9 7/8"

POTTS-SMITH



PC 08-2021-18  
18 cm/7 1/8"

PC 08-2021-21  
21 cm/8 1/4"

PC 08-2021-25  
25 cm/9 7/8"



BROPHY



PC 08-2022-20  
20 cm/7 7/8"



PC 08-2023-20  
20 cm/7 7/8"



GERALD  
Serrated  
PC 08-2024-18 Str  
PC 08-2025-18 Cvd  
18 cm/7 1/8"

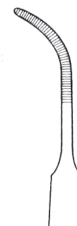

TAYLOR  
PC 08-2026-17  
17.5 cm/6 7/8"

with  
dissector

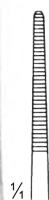

TAYLOR  
Dissector end  
PC 08-2027-17  
17.5 cm/6 7/8"

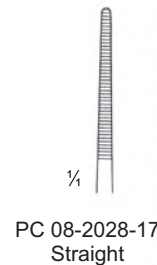

CUSHING  
17.5 cm/6 7/8"



PC 08-2028-17  
Straight



PC 08-2029-17  
Curved

Dissecting Forceps — EN  
 Anatomische Pinzetten — DE  
 Pinzas de disección — ES



**WAUGH**  
 PC 08-2030-15 15 cm/5 7/8"  
 PC 08-2030-20 20 cm/7 7/8"  
**WAUGH**  
 PC 08-2031-15 15 cm/5 7/8"  
 PC 08-2031-20 20 cm/7 7/8"  
 1 x 2 teeth

**DUEHRSSSEN**  
 PC 08-2032-20 20 cm/7 7/8"  
**DUEHRSSSEN**  
 PC 08-2033-20 20 cm/7 7/8"



**LEEDS**  
 PC 08-2034-15 15 cm/5 7/8"  
 PC 08-2034-17 17 cm/6 3/4"  
 PC 08-2034-20 20 cm/7 7/8"  
 PC 08-2034-25 25 cm/9 7/8"  
**LEEDS**  
 PC 08-2035-15 15 cm/5 7/8"  
 PC 08-2035-17 17 cm/6 3/4"  
 PC 08-2035-20 20 cm/7 7/8"

**RAMSEY**  
 PC 08-2037-18 18 cm/7 1/8"  
 1 x 2 Teeth  
 PC 08-2038-18 18 cm/7 1/8"  
 2 x 3 Teeth

**MAINGOT**  
 PC 08-2039-28 28 cm/11"

- EN —● Dissecting Forceps  
 DE —● Anatomische Pinzetten  
 ES —● Pinzas de disección



**EVANS McINDOE**  
 PC 08-2040-15  
 15 cm/5 7/8"



**FISCHL**  
 PC 08-2041-15  
 15 cm/5 7/8"



PC 08-2042-25  
 25 cm/9 7/8"



PC 08-2043-30  
 30 cm/11 3/4"



**LLANDOUGH**  
 PC 08-2044-15  
 15 cm/5 7/8"



**BARSKY**  
 PC 08-2045-15  
 15 cm/5 7/8"



**BARSKY**  
 PC 08-2046-18  
 18 cm/7 1/8"



**WANGENSTEEN**  
 PC 08-2047-23  
 23 cm/9"



**DOTT**  
 PC 08-2048-18  
 18 cm/7 1/8"



Tissue Forceps — EN  
 Chirurgische Pinzetten — DE  
 Pinzas de disección con diente — ES

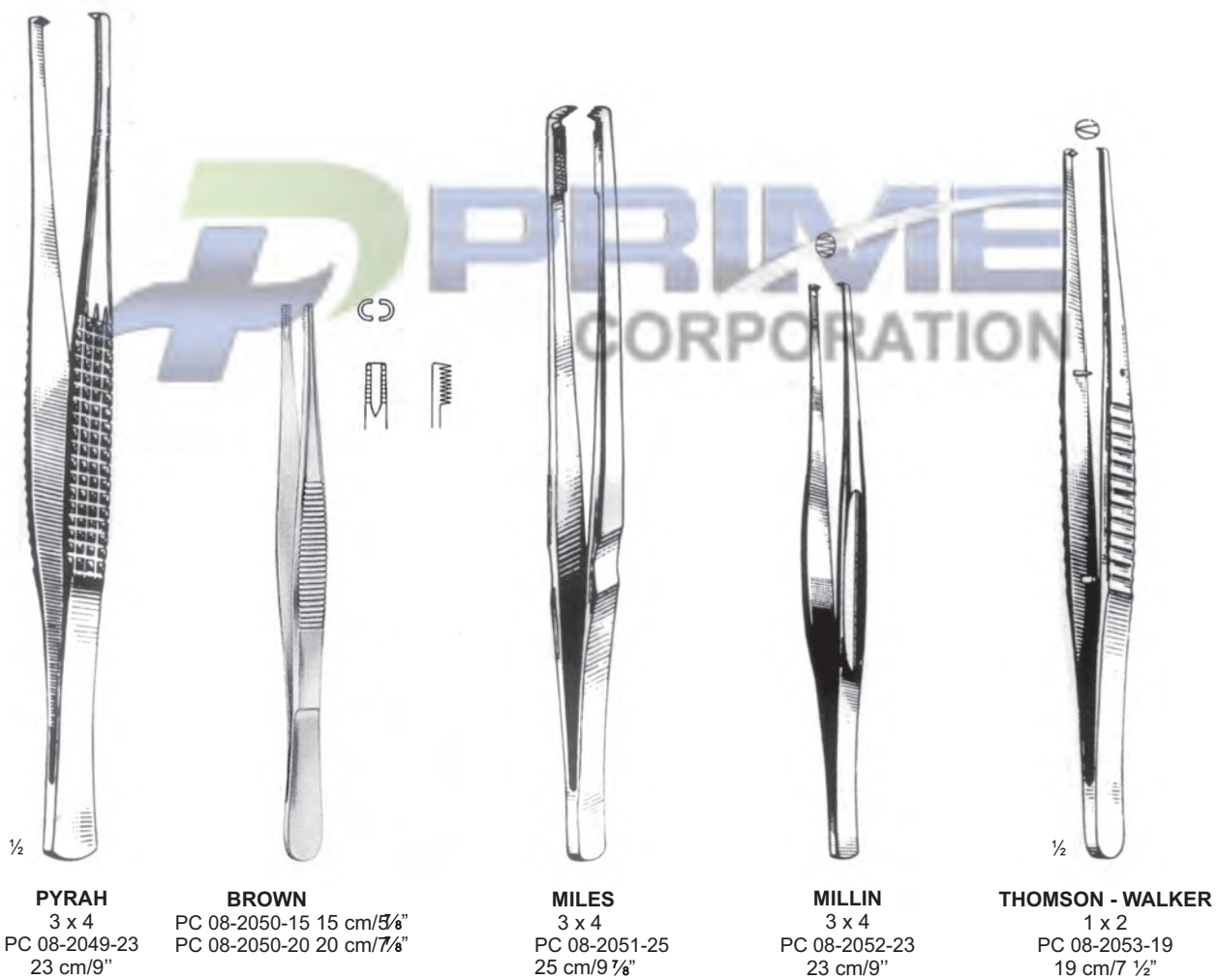

1/2  
**PYRAH**  
 3 x 4  
 PC 08-2049-23  
 23 cm/9"

**BROWN**  
 PC 08-2050-15 15 cm/5 7/8"  
 PC 08-2050-20 20 cm/7 7/8"

**MILES**  
 3 x 4  
 PC 08-2051-25  
 25 cm/9 7/8"

**MILLIN**  
 3 x 4  
 PC 08-2052-23  
 23 cm/9"

1/2  
**THOMSON - WALKER**  
 1 x 2  
 PC 08-2053-19  
 19 cm/7 1/2"

- EN —● Tissue Forceps
- DE —● Chirurgische Pinzetten
- ES —● Pinzas de disección con diente



STANDARD

cm	in	1 : 2	2 : 3	3 : 4	4 : 5	1 : 2	1 : 2	1 : 2
10.5	4 1/8"	PC 08-2054-10					narrow	curved
11.5	4 1/2"	PC 08-2054-11	PC 08-2055-11					PC 08-2059-11
13.0	5 1/8"	PC 08-2054-13	PC 08-2055-13	PC 08-2056-13	PC 08-2057-13	PC 08-2058-13	PC 08-2059-13	PC 08-2060-13
14.5	5 3/4"	PC 08-2054-14	PC 08-2055-14	PC 08-2056-14	PC 08-2057-14	PC 08-2058-14	PC 08-2059-14	PC 08-2060-14
16.0	6 1/4"	PC 08-2054-16	PC 08-2055-16	PC 08-2056-16	PC 08-2057-16	PC 08-2058-16	PC 08-2059-16	
18.0	7 1/8"	PC 08-2054-18	PC 08-2055-18			PC 08-2058-18	PC 08-2059-18	
20.0	7 7/8"	PC 08-2054-20	PC 08-2055-20			PC 08-2058-20		
23.0	9"	PC 08-2054-23						
25.0	9 7/8"	PC 08-2054-25	PC 08-2055-25					
30.0	11 3/4"	PC 08-2054-30	PC 08-2055-30					

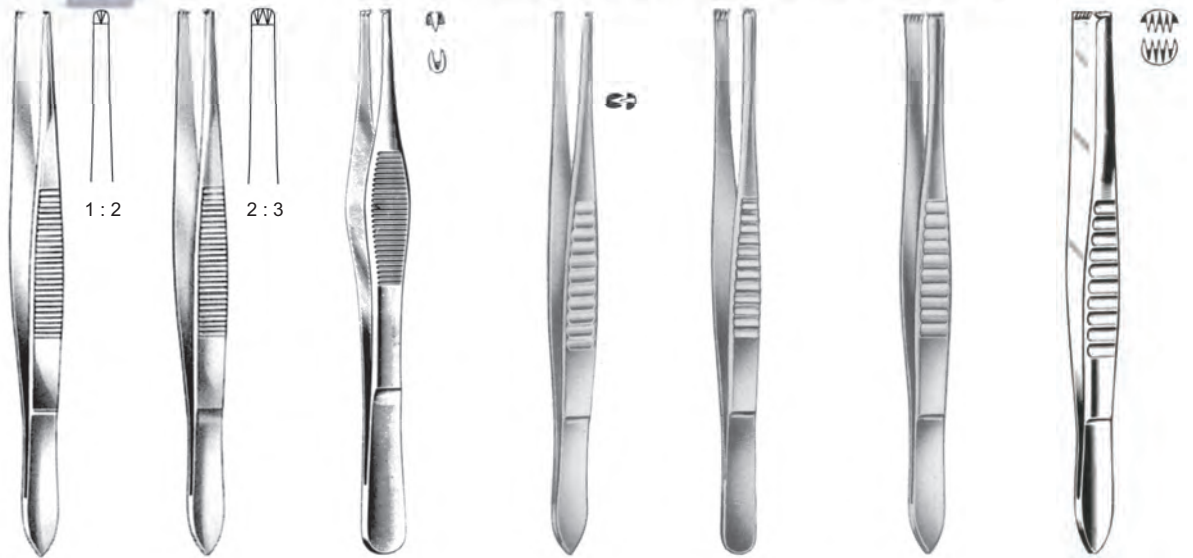

cm	in	1 : 2	2 : 3	1 : 2	1 : 2	2 : 3	3 : 4	4 : 5
		<b>STILLE</b>	<b>STILLE</b>		<b>MOD. USA</b>			
12.0	4 3/4"				PC 08-2064-12	PC 08-2065-12		
13.0	5 1/8"			PC 08-2063-13	PC 08-2064-13	PC 08-2065-13	PC 08-2066-13	PC 08-2067-13
14.5	5 3/4"			PC 08-2063-14	PC 08-2064-14	PC 08-2065-14	PC 08-2066-14	PC 08-2067-14
15.0	5 7/8"	PC 08-2061-15	PC 08-2062-15					
15.5	6 1/8"			PC 08-2064-15	PC 08-2065-15	PC 08-2066-15	PC 08-2067-15	
18.5	7 1/4"			PC 08-2064-18	PC 08-2065-18			
21.0	8 1/4"			PC 08-2064-21	PC 08-2065-21			
25.0	9 7/8"			PC 08-2064-25	PC 08-2065-25			
31.0	12 1/4"			PC 08-2064-31	PC 08-2065-31			

Tissue Forceps — EN  
 Chirurgische Pinzetten — DE  
 Pinzas de disección con diente — ES

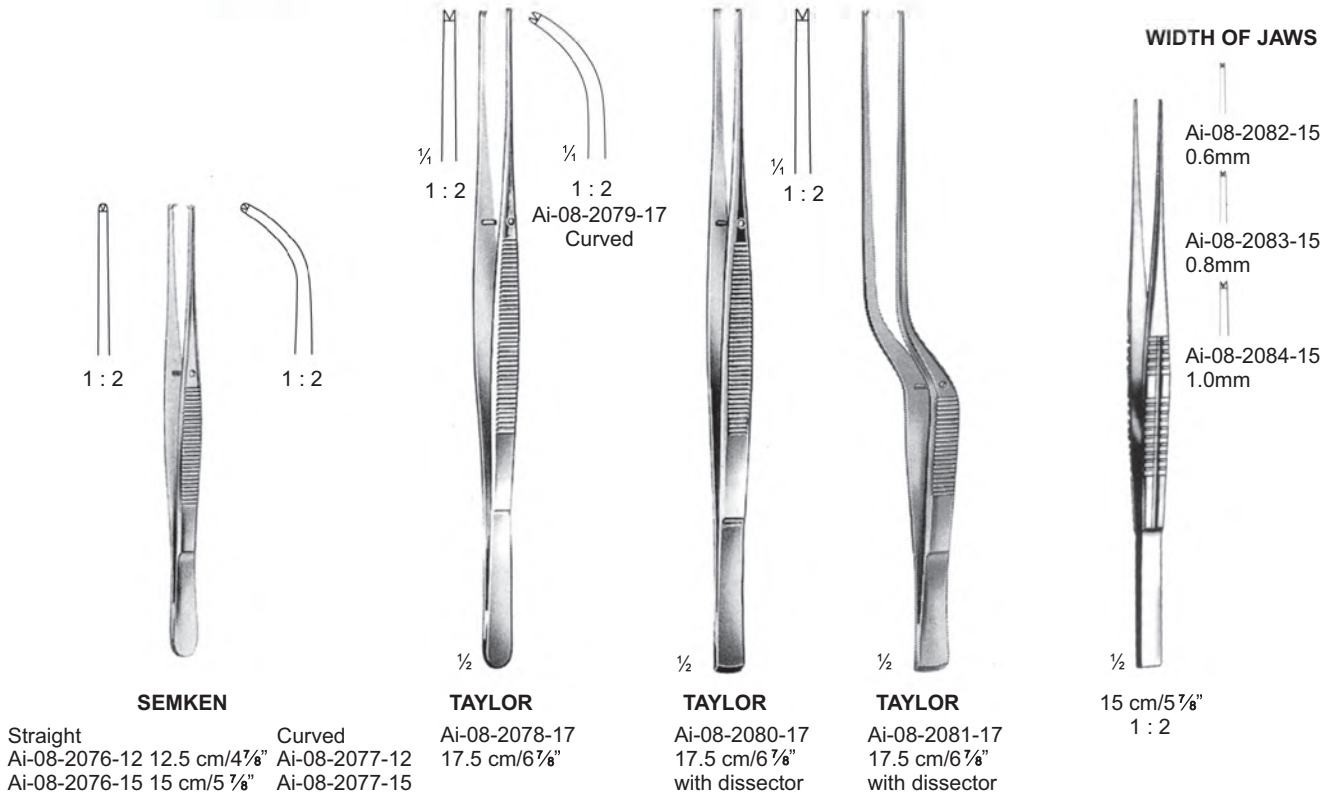
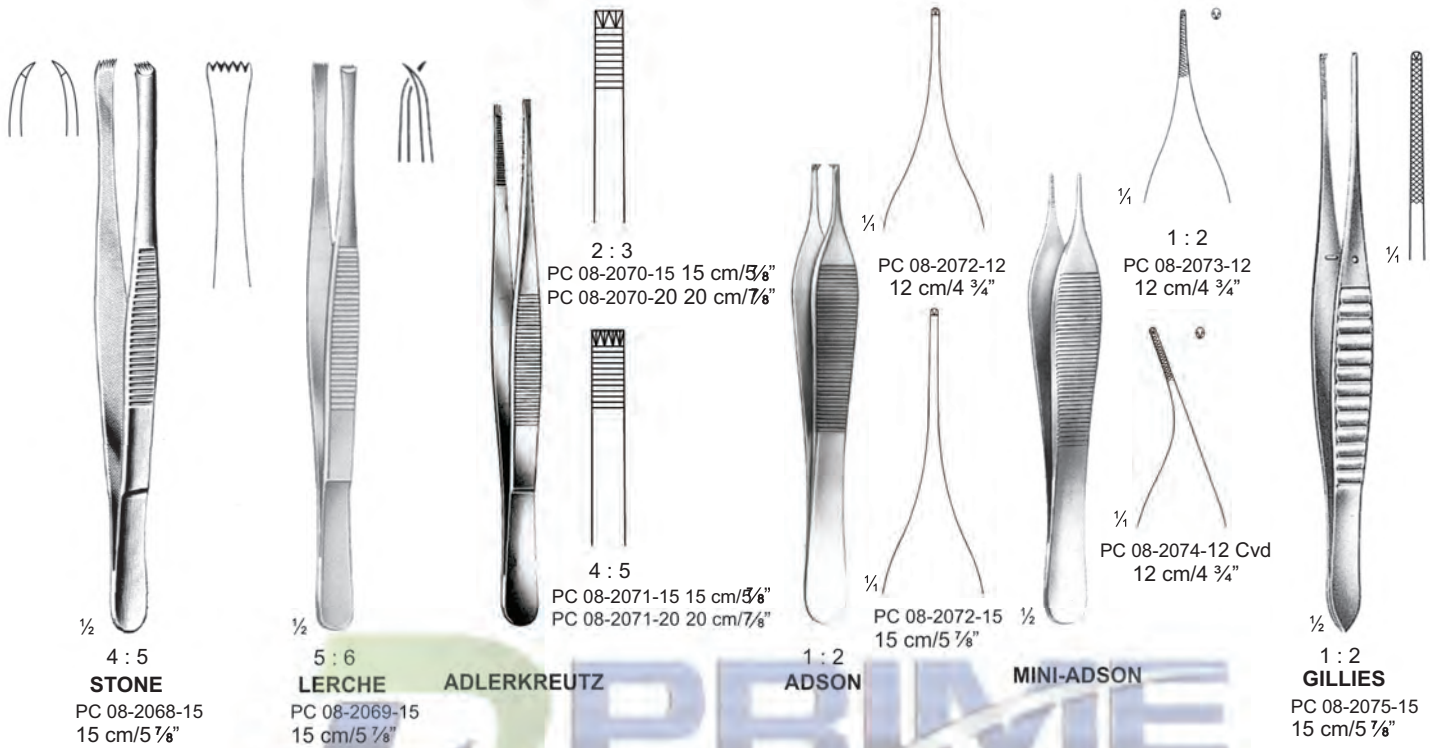

- EN —● Tissue Forceps, Micro Forceps
- DE —● Chirurgische Pinzetten, Mikro-Pinzetten
- ES —● Pinzas de disección con diente, Micro-pinzas

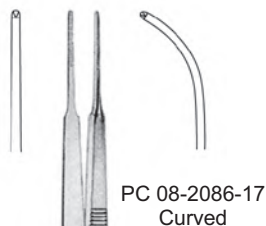

**GERALD**  
1 : 2  
PC 08-2085-17  
17 cm/6 3/4"

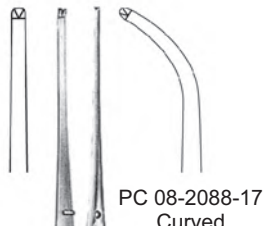

**CUSHING**  
1 : 2  
PC 08-2087-17  
17 cm/6 3/4"



**POTTS-SMITH**  
PC 08-2089-18 18 cm/7 1/8"  
PC 08-2089-21 21 cm/8 1/4"  
PC 08-2089-25 25 cm/9 5/8"

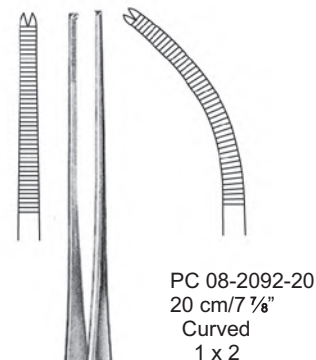

**BROPHY**  
1 x 2  
PC 08-2091-20  
20 cm/7 7/8"



**ADSON-BROWN**  
PC 08-2093-12  
12 cm/4 3/4"



**MICRO-ADSON**

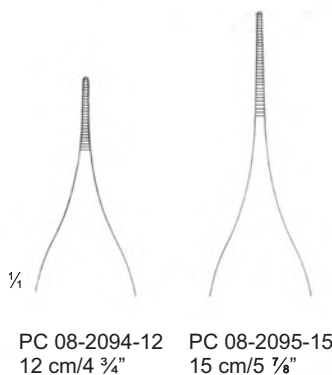

PC 08-2094-12 12 cm/4 3/4"  
PC 08-2095-15 15 cm/5 1/8"



**MICRO-ADSON**

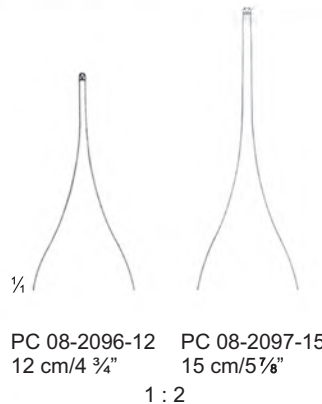

PC 08-2096-12 12 cm/4 3/4"  
PC 08-2097-15 15 cm/5 1/8"  
1 : 2

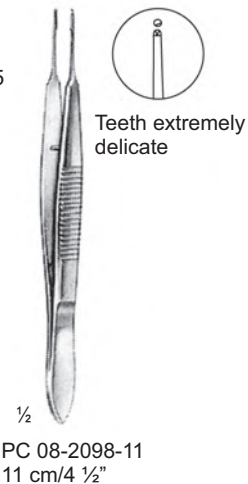

**MICRO-ADSON**  
PC 08-2098-11  
11 cm/4 1/2"



Tissue Forceps — EN  
 Chirurgische Pinzetten — DE  
 Pinzas de disección con diente — ES



**TREVES**  
 PC 08-2099-13 13 cm/5 1/8"  
 PC 08-2099-15 15 cm/5 7/8"

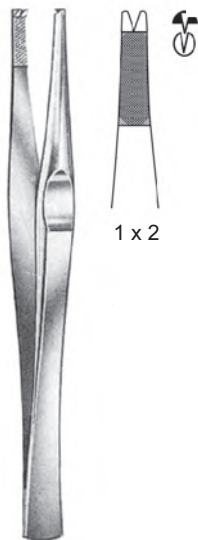

**LANE**  
 PC 08-2100-14 14 cm/5 1/2"  
 PC 08-2100-20 20 cm/7 7/8"

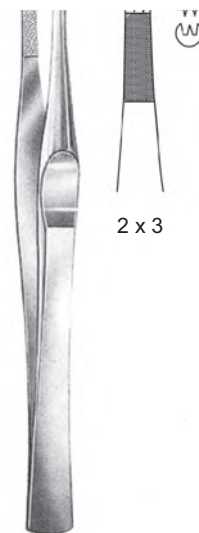

**LANE**  
 PC 08-2101-14 14 cm/5 1/2"  
 PC 08-2101-20 20 cm/7 7/8"

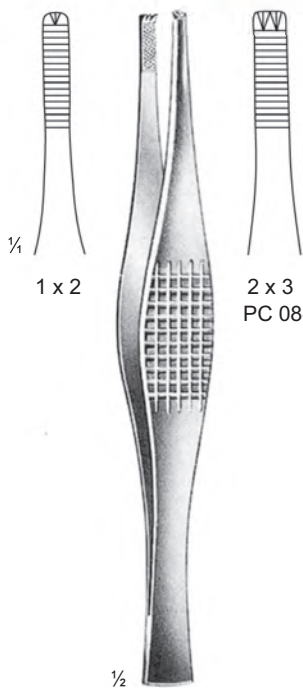

**FERRIS-SMITH**  
 PC 08-2102-18  
 18 cm/7 1/8"

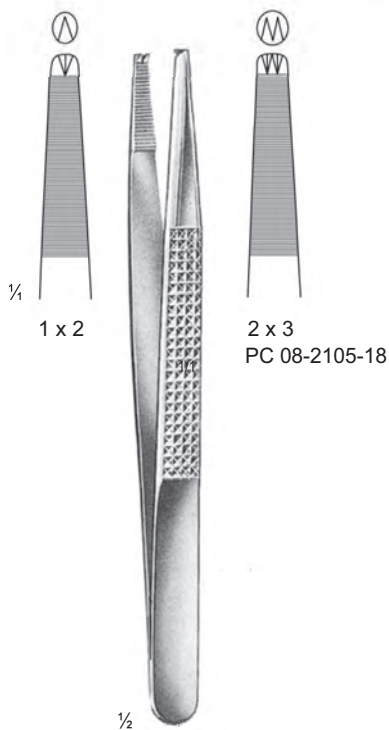

**BONNEY**  
 PC 08-2104-18  
 18 cm/7 1/8"

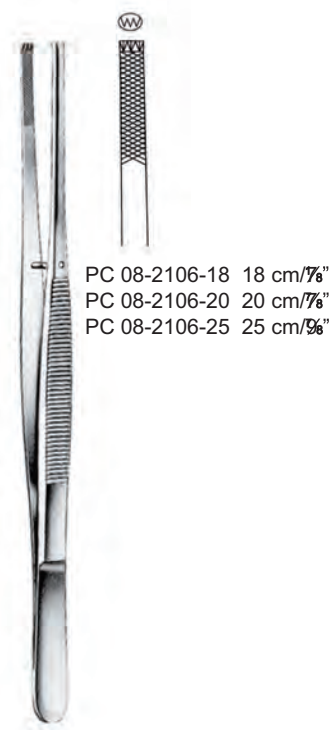

**STILLE-BARRAYA**

PC 08-2106-18 18 cm/7 1/8"  
 PC 08-2106-20 20 cm/7 7/8"  
 PC 08-2106-25 25 cm/9 7/8"

- EN —● Tissue Forceps, Grasping Forceps
- DE —● Chirurgische Pinzetten, Faßpinzetten
- ES —● Pinzas de disección con diente, Pinzas para agarrar

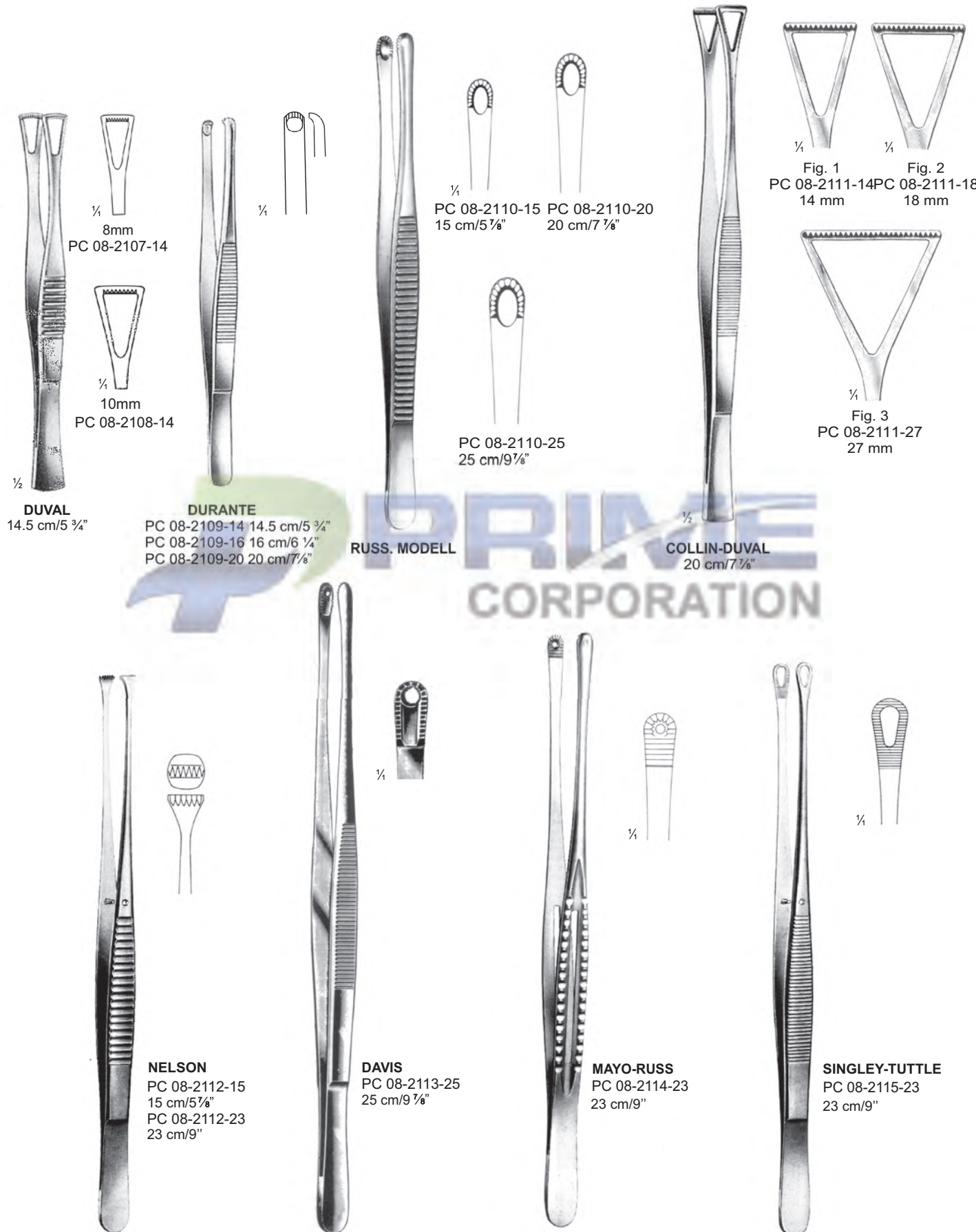

**DUVAL**  
 14.5 cm/5 3/4"  
 8mm  
 PC 08-2107-14  
 10mm  
 PC 08-2108-14

**DURANTE**  
 PC 08-2109-14 14.5 cm/5 3/4"  
 PC 08-2109-16 16 cm/6 1/4"  
 PC 08-2109-20 20 cm/7 7/8"

**RUSS. MODELL**

PC 08-2110-15 15 cm/5 7/8"  
 PC 08-2110-20 20 cm/7 7/8"  
 PC 08-2110-25 25 cm/9 7/8"

**COLLIN-DUVAL**  
 20 cm/7 7/8"

Fig. 1  
 PC 08-2111-14PC 08-2111-18  
 14 mm 18 mm  
 Fig. 2  
 Fig. 3  
 PC 08-2111-27  
 27 mm

**NELSON**  
 PC 08-2112-15 15 cm/5 7/8"  
 PC 08-2112-23 23 cm/9"

**DAVIS**  
 PC 08-2113-25 25 cm/9 7/8"

**MAYO-RUSS**  
 PC 08-2114-23 23 cm/9"

**SINGLEY-TUTTLE**  
 PC 08-2115-23 23 cm/9"

Tissue Forceps EN  
 Chirurgische Pinzetten EN DE  
 Pinzas de disección con diente DE ES  
 ES



**LEEDS**

1 x 2

PC 08-2116-15 15 cm/5"  
 PC 08-2116-17 17 cm/6 3/4"  
 PC 08-2116-20 20 cm/7 7/8"



**LEEDS**

2 x 3

PC 08-2117-15  
 15 cm/5 7/8"



**JEAN**

1 x 2

PC 08-2118-14 14 cm/5 1/2"  
 PC 08-2118-18 18 cm/7 1/8"

- EN —● Forceps, Fine Patterns, Cilia Forceps, Splinter Forceps
- DE —● Pinzetten, feine modelle, Cillenpinzetten, Spitter-Pinzetten
- ES —● Pinzas, modelos finos, Pinzas depilatorias, Pinzas para espinas

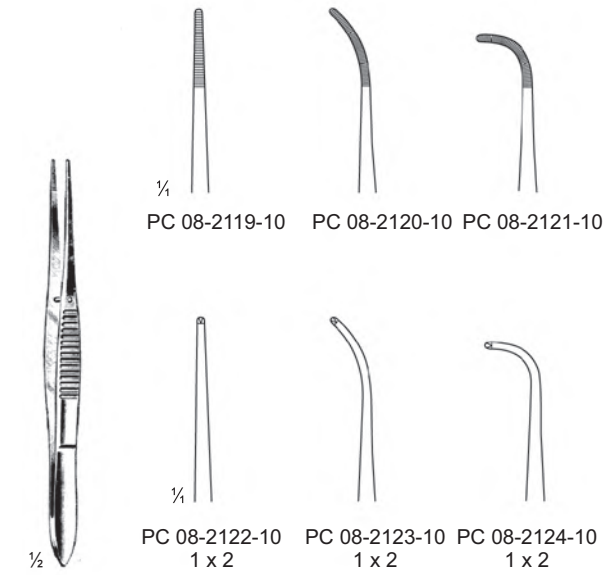

**GRAEFE-IRIS**  
10.5 cm/4 1/8"

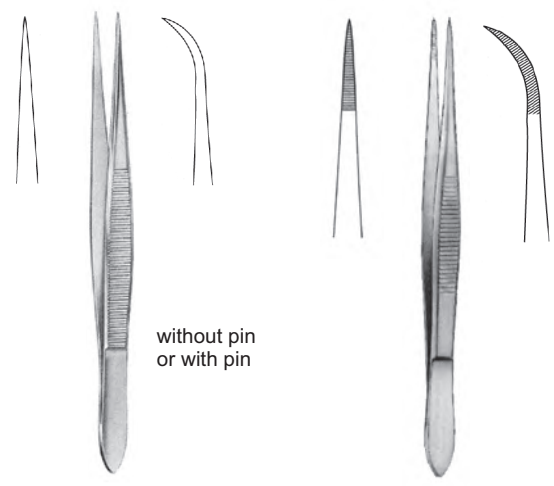

	Smooth	Serrated
8 cm/3 1/4"	PC 08-2125-08	PC 08-2126-08
9 cm/3 1/2"	PC 08-2125-09	PC 08-2126-09
10.5 cm/4 1/8"	PC 08-2125-10	PC 08-2126-10
11.5 cm/4 1/2"	PC 08-2125-11	PC 08-2126-11
12.5 cm/4 7/8"	PC 08-2125-12	PC 08-2126-12

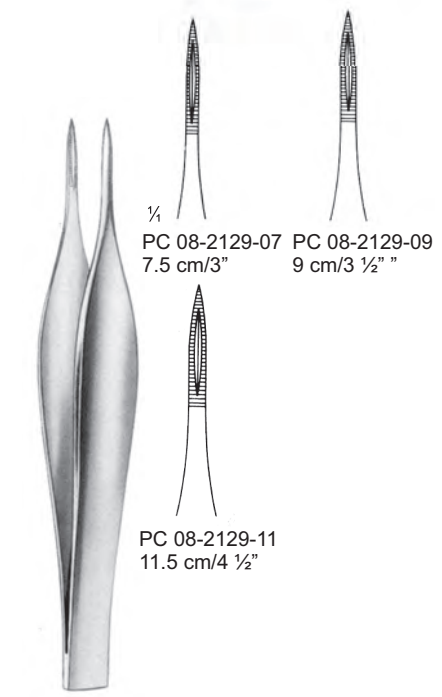
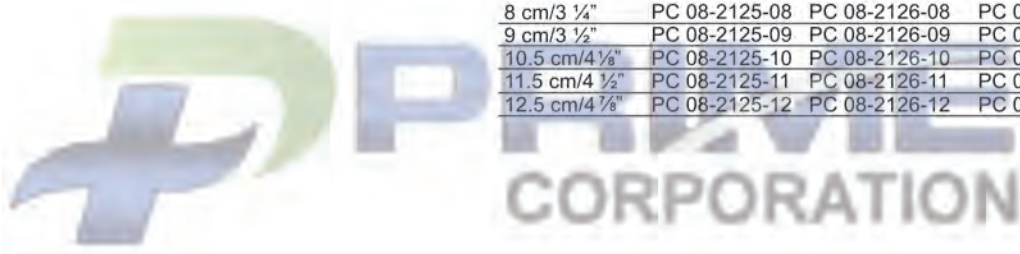

**FEILCHENFELD**

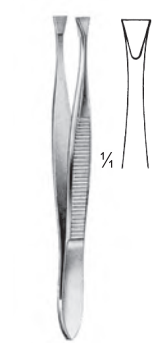

**PC 08-2130-08**  
8.5 cm/3 3/8"  
Littauer

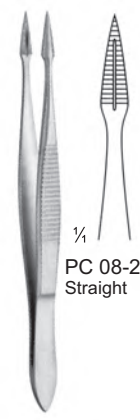

**HUNTER**  
10.5 cm/4 1/8"

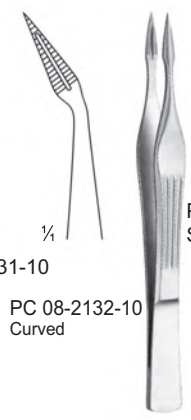

**WALTER-CARMALT**  
10.5 cm/4 1/8"

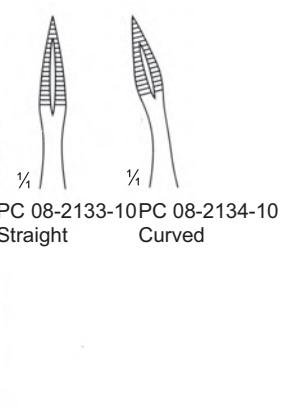

**PC 08-2133-10** Straight  
**PC 08-2134-10** Curved



- Splinter Forceps ●— EN
- Spitter-Pinzetten ●— DE
- Pinzas para espinas ●— ES

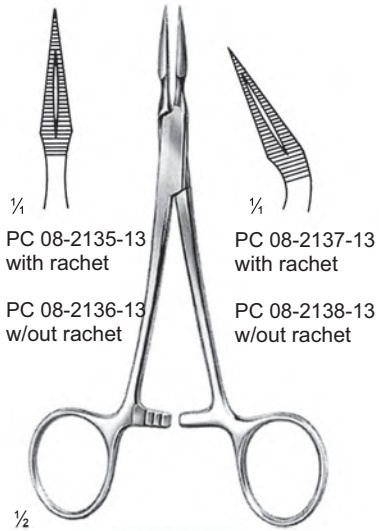

PC 08-2135-13  
with ratchet

PC 08-2137-13  
with ratchet

PC 08-2136-13  
w/out ratchet

PC 08-2138-13  
w/out ratchet

1/2

**STIEGLITZ**  
13.5 cm/5 3/8"



**PEET**  
PC 08-2139-11  
11.5 cm/4 1/2"

1/4

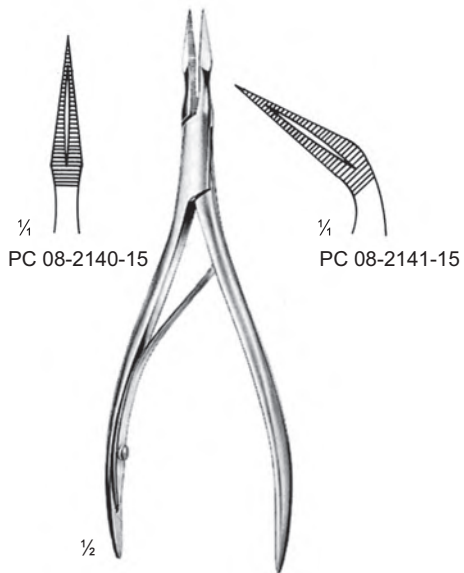

PC 08-2140-15

PC 08-2141-15

1/2

**RALK**  
15 cm/5 7/8"

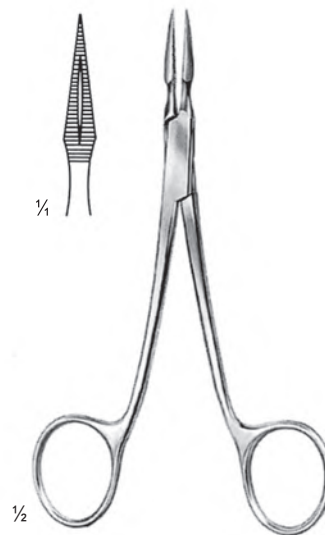

1/4

1/2

**ARTHUR**  
PC 08-2142-14  
14 cm/5 1/2"

- EN —● Micro Forceps
- DE —● Mikro-Pinzetten
- ES —● Micro-Pinzas

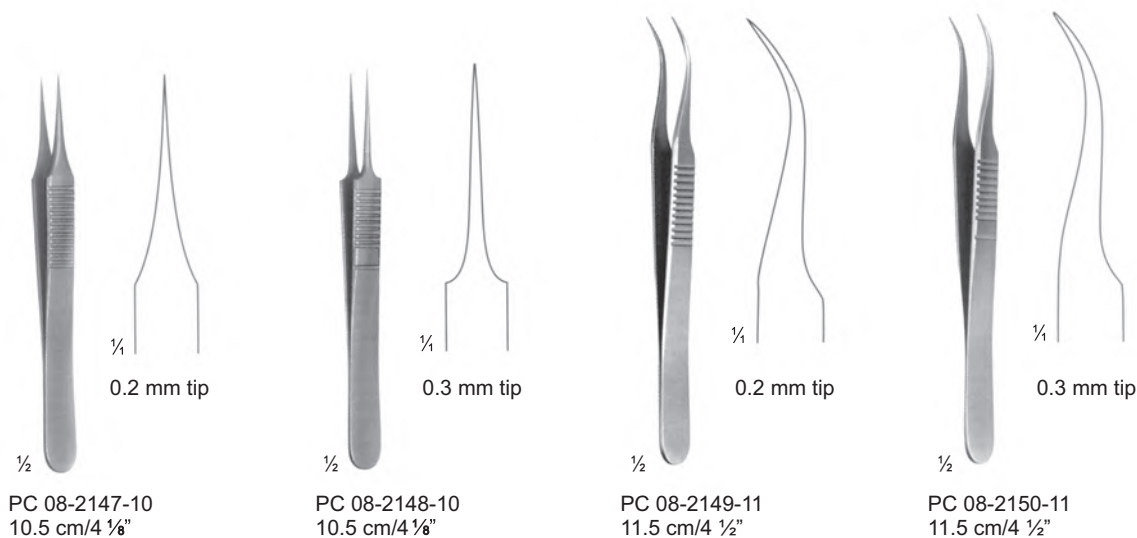
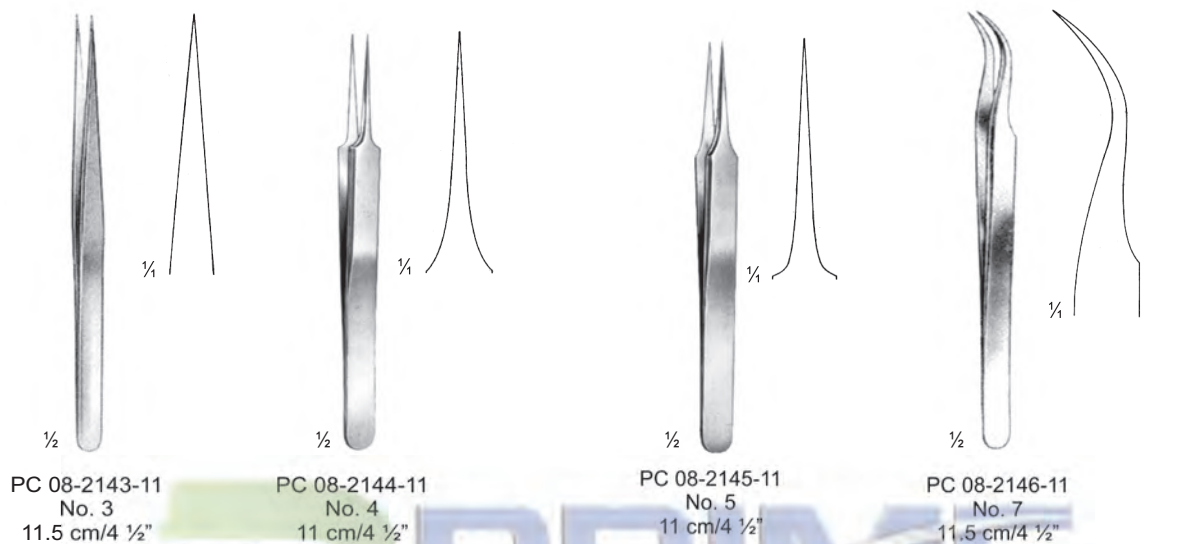

- Bulldog Clamps ● EN
- Bulldogklemmen ● DE
- Clamps bulldog ● ES



DIEFFENBACH

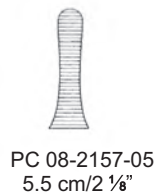
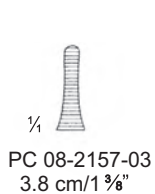
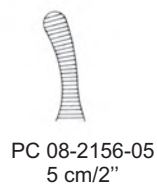
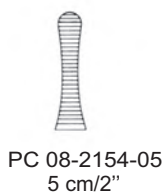
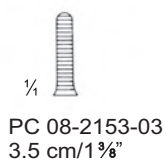
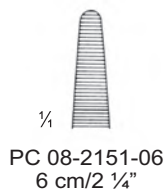

DIEFFENBACH

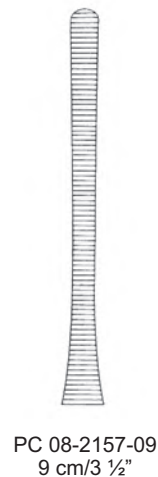
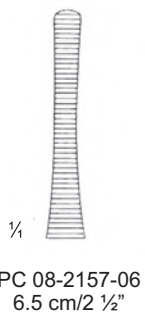

**FORCEPS**

- EN —● Bulldog Clamps
- DE —● Bulldogklemmen
- ES —● Clamps bulldog

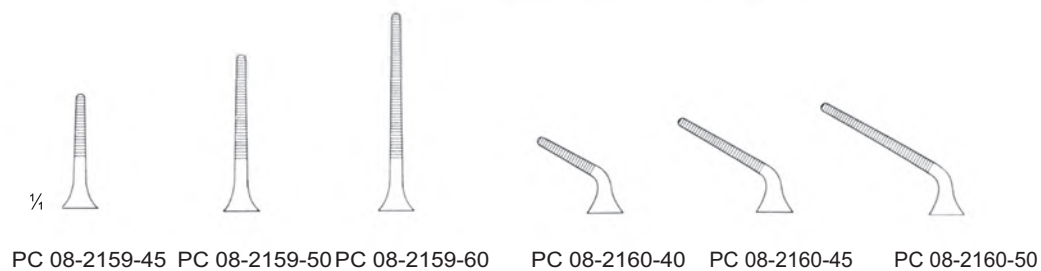
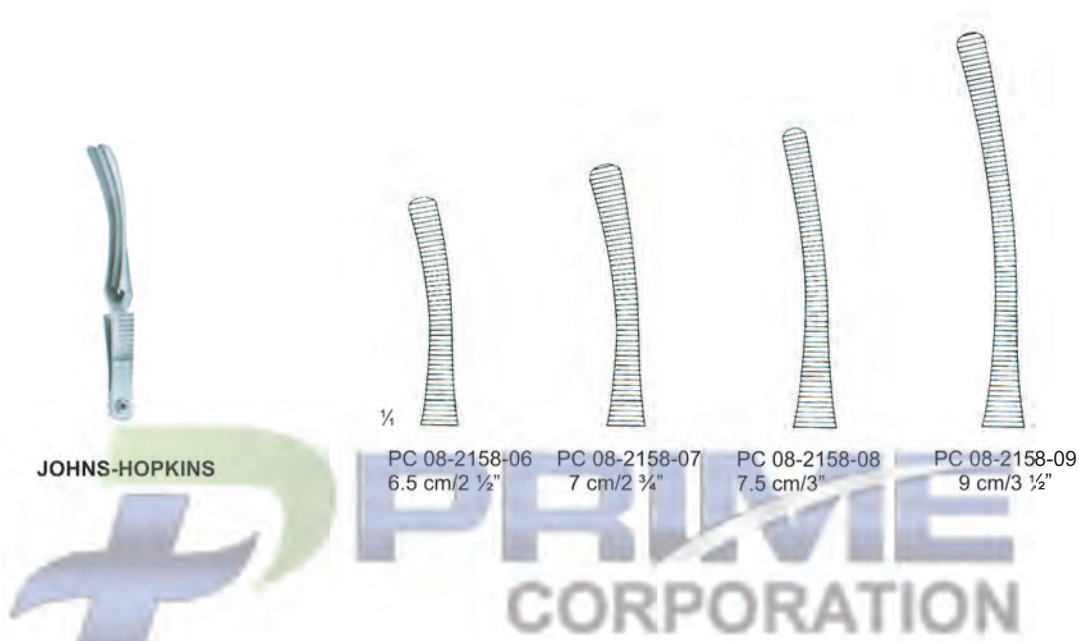

**DIETRICH**

	PC 08-2159-45	PC 08-2159-50	PC 08-2159-60	PC 08-2160-40	PC 08-2160-45	PC 08-2160-50
Length	45 mm	50 mm	60 mm	40 mm	45 mm	50 mm
Jaw Length	8 mm	12 mm	20 mm	8 mm	12 mm	20 mm
Closing Pressure	50 gr	50 gr	50 gr	50 gr	50 gr	50 gr
Weight	3 gr	3 gr	3 gr	3 gr	3 gr	3 gr



- Bulldog Clamps ●— EN
- Bulldogklemmen ●— DE
- Clamps bulldog ●— ES

**ATRAUMA**



PC 08-2161-45 PC 08-2161-50 PC 08-2161-60 PC 08-2162-35 PC 08-2162-45 PC 08-2162-50

Length	45 mm	50 mm	60 mm	35 mm	45 mm	50 mm
Jaw Length	10 mm	14 mm	20 mm	10 mm	14 mm	20 mm
Closing Pressure	180 gr	180 gr	180 gr	180 gr	180 gr	180 gr
Weight	3 gr	3 gr	3 gr	3 gr	3 gr	3 gr

**DE BAKEY-DIETRICH**

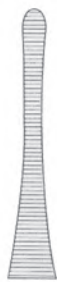

**JOHNS-HOPKINS**  
 PC 08-2163-05 5 cm/2"  
 PC 08-2163-06 6.5 cm/2 1/2"  
 PC 08-2163-07 7.5 cm/3"



**JOHNS-HOPKINS**  
 PC 08-2164-05 5 cm/2"  
 PC 08-2164-06 6.5 cm/2 1/2"  
 PC 08-2164-07 7.5 cm/3"



**HESS** L  
 PC 08-2165-20 20 mm  
 PC 08-2165-30 30 mm

- EN —● Bulldog Clamps
- DE —● Bulldogklemmen
- ES —● Clamps bulldog

**ATRAUMA**



- Bulldog Clamps ● EN
- Bulldogklemmen ● DE
- Clamps bulldog ● ES

ATRAUMA



GREGORY SOFT  
Carotid Clamp



PC 08-2171-09  
9 cm/3 1/2"



PC 08-2171-11  
11 cm/4 3/8"



GREGORY  
Carotid Clamp



PC 08-2172-10  
10.5 cm/4 1/8"  
Right



PC 08-2173-10  
10.5 cm/4 1/8"  
Left

- EN —● Bulldog Clamps
- DE —● Bulldogklemmen
- ES —● Clamps bulldog

**ATRAUMA**



DEBAKEY



- PC 08-2174-07  
7.5 cm/3"
- PC 08-2174-08  
8.5 cm/3 3/8"
- PC 08-2174-10  
10 cm/3 7/8"
- PC 08-2174-12  
12 cm/4 3/4"



DEBAKEY

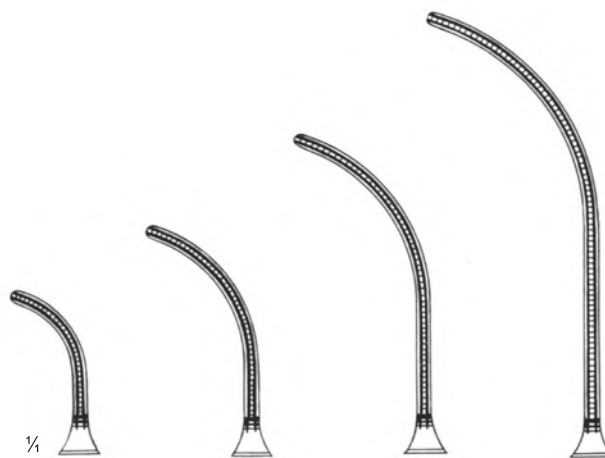

- PC 08-2175-07  
7.5 cm/3"
- PC 08-2175-08  
8.5 cm/3 3/8"
- PC 08-2175-09  
9.5 cm/3 7/8"
- PC 08-2175-11  
11 cm/4 3/8"



- Bulldog Clamps ● EN
- Bulldogklemmen ● DE
- Clamps bulldog ● ES

ATRAUMA

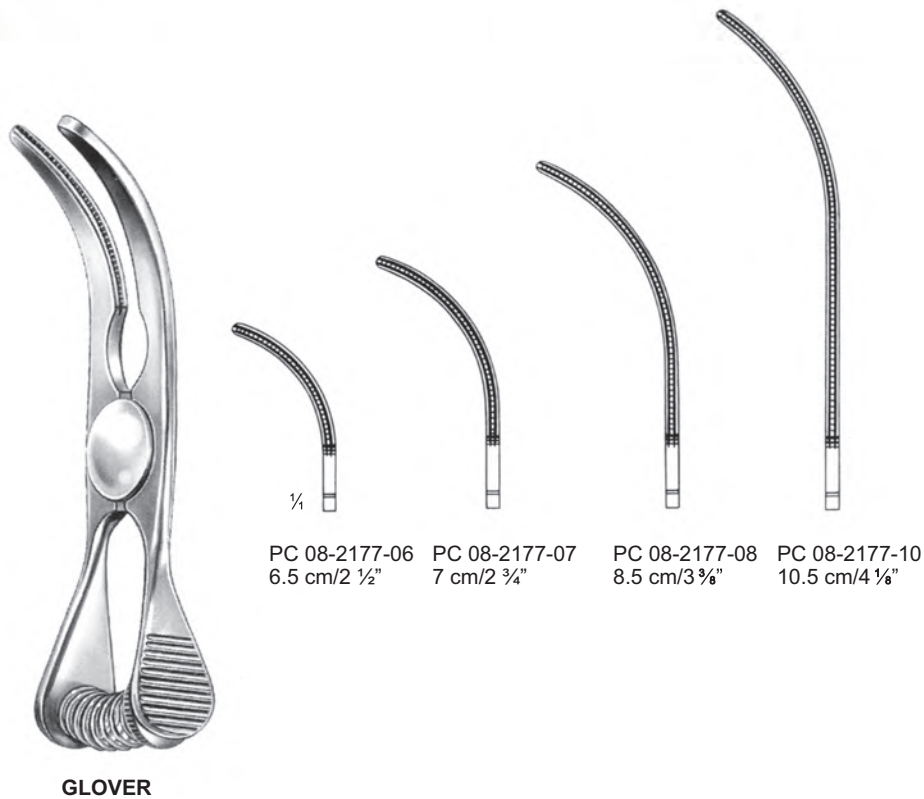

- EN —● Bulldog Clamps
- DE —● Bulldogklemmen
- ES —● Clamps bulldog



Applying forceps for Johns-Hopkins  
and DeBakey Bulldog clamps

Vascular Forceps ●— EN  
 Gefäßpinzetten ●— DE  
 Pinzas de disección vascular ●— ES

## ATRAUMA



¼  
 PC 08-2179-16 16 cm/6 ¼"  
 PC 08-2179-20 20 cm/7 ⅞"  
 PC 08-2179-24 24.5 cm/9 ⅝"  
 PC 08-2179-30 30 cm/11 ¾"

**DEBAKEY**  
2.7 mm

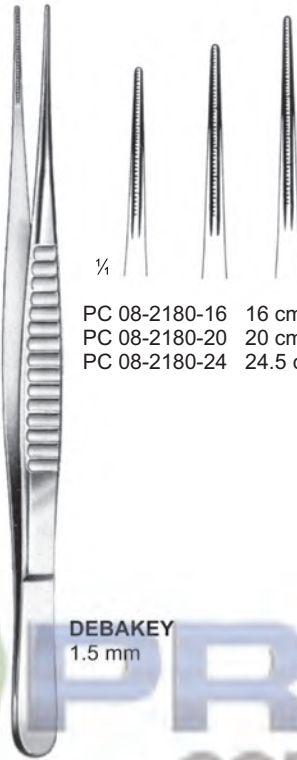

¼  
 PC 08-2180-16 16 cm/6 ¼"  
 PC 08-2180-20 20 cm/7 ⅞"  
 PC 08-2180-24 24.5 cm/9 ⅝"

**DEBAKEY**  
1.5 mm

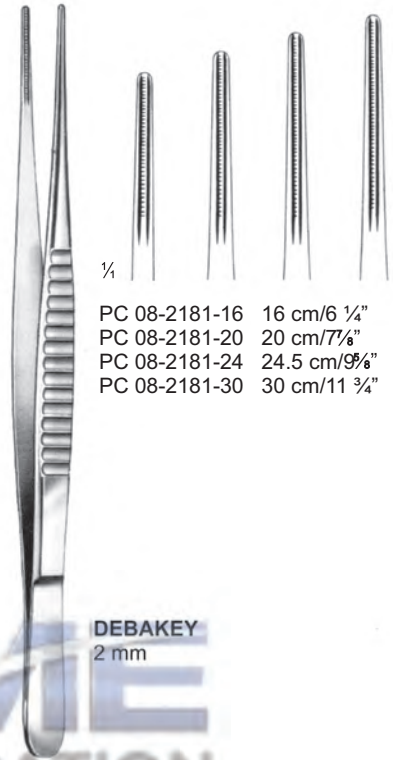

¼  
 PC 08-2181-16 16 cm/6 ¼"  
 PC 08-2181-20 20 cm/7 ⅞"  
 PC 08-2181-24 24.5 cm/9 ⅝"  
 PC 08-2181-30 30 cm/11 ¾"

**DEBAKEY**  
2 mm

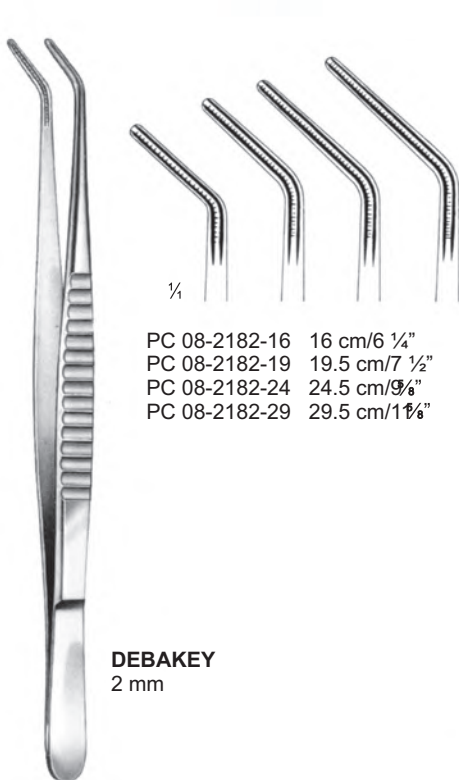

¼  
 PC 08-2182-16 16 cm/6 ¼"  
 PC 08-2182-19 19.5 cm/7 ½"  
 PC 08-2182-24 24.5 cm/9 ⅝"  
 PC 08-2182-29 29.5 cm/11 ⅞"

**DEBAKEY**  
2 mm

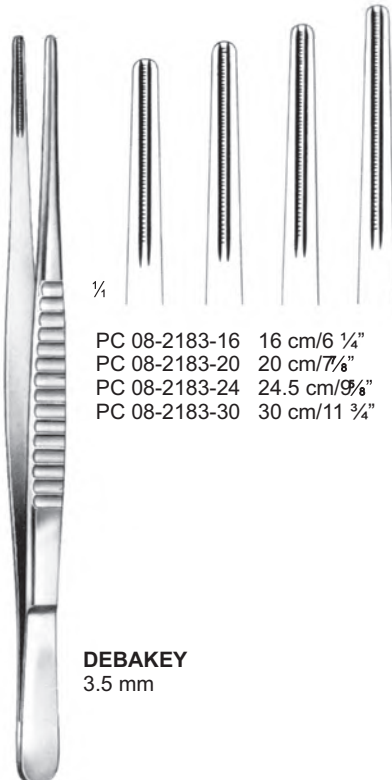

¼  
 PC 08-2183-16 16 cm/6 ¼"  
 PC 08-2183-20 20 cm/7 ⅞"  
 PC 08-2183-24 24.5 cm/9 ⅝"  
 PC 08-2183-30 30 cm/11 ¾"

**DEBAKEY**  
3.5 mm

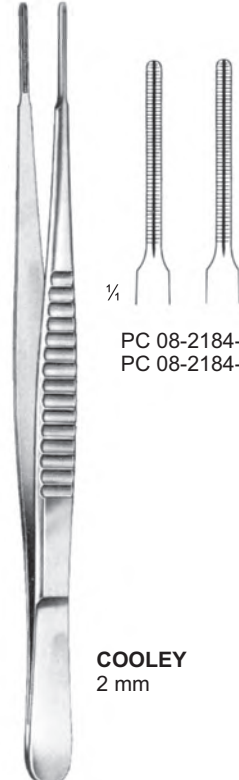

¼  
 PC 08-2184-16 16 cm/6 ¼"  
 PC 08-2184-20 20 cm/7 ⅞"

**COOLEY**  
2 mm

**EN** TC Forceps

**DE** TC-Zange

**ES** Pinzas TC

Page 111 to 114





- EN —● Dissecting Forceps
- DE —● Anatomische Pinzetten
- ES —● Pinzas de disección



ADSON

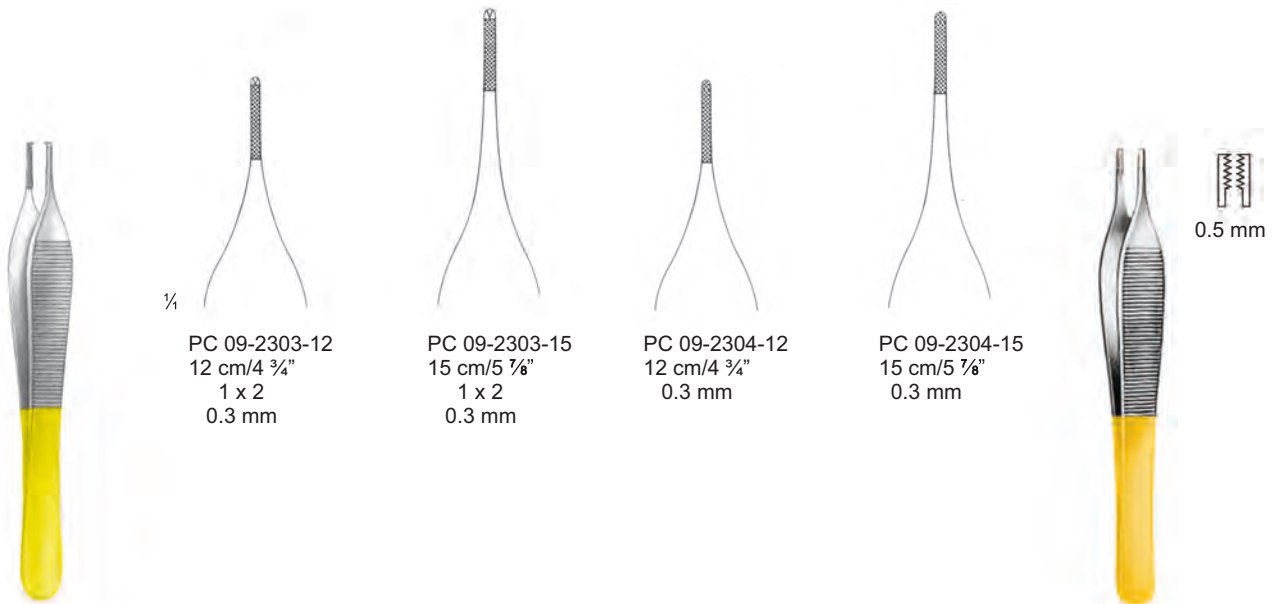
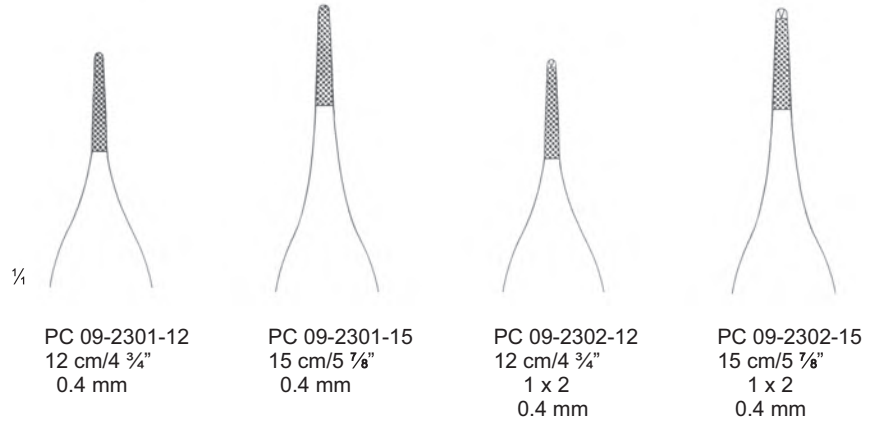

MICRO ADSON

ADSON BROWN  
PC 09-2305-12  
12 cm/4 ¾"

Vascular Forceps ●— EN  
 Gefäßpinzetten ●— DE  
 Pinzas de disección vascular ●— ES



0.5 mm



¼

PC 09-2307-14  
 14.5 cm/5 ¾"  
 0.5 mm



PC 09-2307-16  
 16 cm/6 ¼"  
 0.5 mm



PC 09-2307-18  
 18 cm/7 ½"  
 0.5 mm

¼

PC 09-2307-20  
 20 cm/7 ⅞"  
 0.5 mm



PC 09-2307-25  
 25 cm/9 ⅞"  
 0.5 mm

**STANDARD**

- PC 09-2306-14 14.5 cm/5 ¾"
- PC 09-2306-16 16 cm/6 ¼"
- PC 09-2306-18 18 cm/7 ½"
- PC 09-2306-20 20 cm/7 ⅞"
- PC 09-2306-25 25 cm/9 ⅞"
- PC 09-2306-30 30 cm/11 ¾"

**OEHLER**



¼

0.5 mm  
 PC 09-2308-15  
 Regular

**USA MOD.**  
 15 cm/5 ⅞"

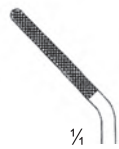

¼

0.5 mm  
 PC 09-2309-17



¼

0.5 mm  
 PC 09-2310-17

**CUSHING**  
 17.5 cm/6 ⅞"



¼

0.5 mm  
 PC 09-2311-18

**CUSHING-TAYLOR**  
 18 cm/7 ⅞"

- EN —● Dissecting Forceps, Tissue Forceps
- DE —● Anatomische Pinzetten, Chirurgische Pinzetten
- ES —● Pinzas de disección, Pinzas de disección con diente

**POTTS-SMITH**

- PC 09-2312-16  
16 cm/6 1/4"  
0.5 mm
- PC 09-2312-18  
18 cm/7 1/8"  
0.5 mm
- PC 09-2312-20  
20 cm/7 7/8"  
0.5 mm
- PC 09-2312-23  
23 cm/9"  
0.5 mm
- PC 09-2312-25  
25 cm/9 7/8"  
0.5 mm

**WANGENSTEEN**

- PC 09-2313-15  
15 cm/5 7/8"  
0.5 mm
- PC 09-2313-23  
23 cm/9"  
0.5 mm

**SEMKEN**

- 0.4 mm  
PC 09-2314-15  
15 cm/5 7/8"
- 0.4 mm  
PC 09-2315-15  
15 cm/5 7/8"

**MCINDOE**

- 0.4 mm  
PC 09-2316-15  
15 cm/5 7/8"

**BONNEY**

- 0.5 mm  
PC 09-2317-18  
18 cm/7 1/8"
- 0.5 mm  
PC 09-2318-18  
18 cm/7 1/8"

- Tissue Forceps ●— EN
- Chirurgische Pinzetten ●— DE
- Pinzas de disección con diente ●— ES



**GILLIES**  
 PC 09-2319-15  
 15 cm/5 7/8"

**FERRIS-SMITH**  
 PC 09-2320-18  
 18 cm/7 1/8"

**DEBAKEY-ATRAUMA**  
 PC 09-2321-15 15 cm/5 7/8"  
 PC 09-2321-19 19 cm/7 1/2"  
 PC 09-2321-24 24 cm/9 1/2"



**EN** Titanium Forceps

**DE** Titan-Pinzetten

**ES** Pinzas de titanio

Page 115 to 116

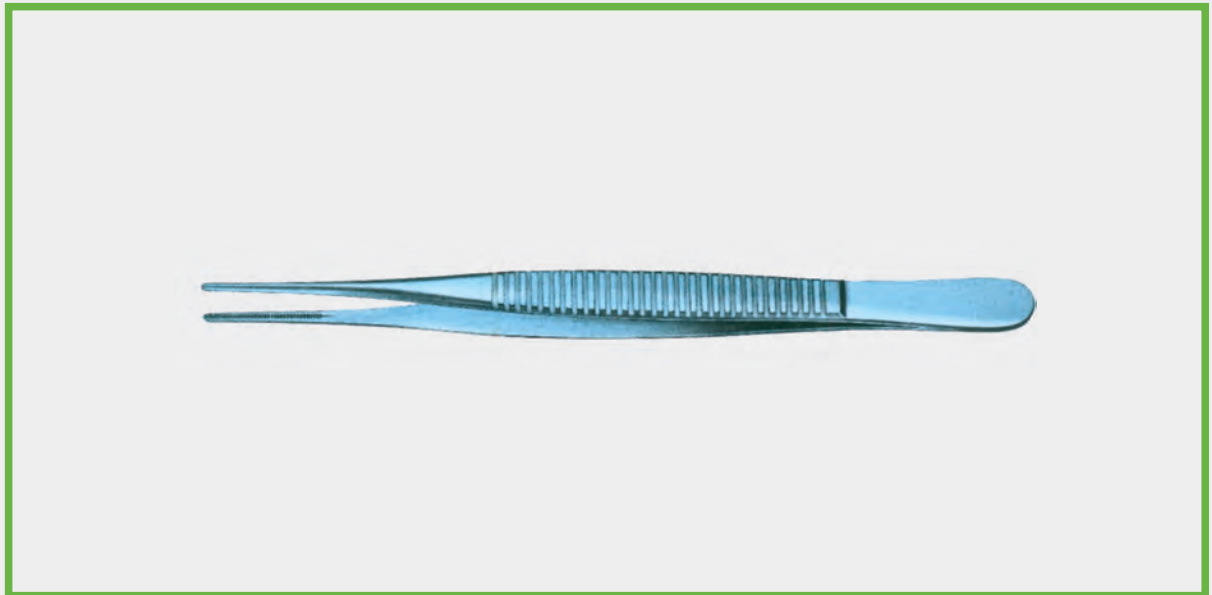

- EN —●— Bulldog Clamps
- DE —●— Bulldogklemmen
- ES —●— Clamps bulldog

ATRAUMA



TITANIUM

	PC 10-2401-00 Vena Closing pressure 110 +/- 10 gr	PC 10-2402-00 Vena Closing pressure 110 +/- 10 gr	PC 10-2403-00 Vena Closing pressure 110 +/- 10 gr	PC 10-2404-00 Vena Closing pressure 110 +/- 10 gr
	Arteria	Arteria	Arteria	Arteria
Closing Pressure	220 +/- 10 gr	220 +/- 10 gr	220 +/- 10 gr	220 +/- 10 gr
Length	30 mm	35 mm	40 mm	50 mm
Jaw Length	9 mm	13 mm	14 mm	23 mm
Weight	1 gr	1 gr	1 gr	1.5 gr



	PC 10-2405-00 Vena Closing pressure 110 +/- 10 gr	PC 10-2406-00 Vena Closing pressure 110 +/- 10 gr	PC 10-2407-00 Vena Closing pressure 110 +/- 10 gr	PC 10-2408-00 Vena Closing pressure 110 +/- 10 gr
	Arteria	Arteria	Arteria	Arteria
Closing Pressure	220 +/- 10 gr	220 +/- 10 gr	220 +/- 10 gr	220 +/- 10 gr
Length	30 mm	35 mm	40 mm	50 mm
Jaw Length	9 mm	13 mm	14 mm	23 mm
Weight	1 gr	1 gr	1 gr	1.5 gr



	PC 10-2409-00 Vena Closing pressure 110 +/- 10 gr	PC 10-2410-00 Vena Closing pressure 110 +/- 10 gr	PC 10-2411-00 Vena Closing pressure 110 +/- 10 gr	PC 10-2412-00 Vena Closing pressure 110 +/- 10 gr
	Arteria	Arteria	Arteria	Arteria
Closing Pressure	220 +/- 10 gr	220 +/- 10 gr	220 +/- 10 gr	220 +/- 10 gr
Length	30 mm	35 mm	40 mm	50 mm
Jaw Length	9 mm	13 mm	14 mm	23 mm
Weight	1 gr	1 gr	1 gr	1.5 gr

Titanium Instruments ●— EN  
 Titan Instrumente ●— DE  
 Instrumentos de titanio ●— ES

## ATRAUMA



## DEBAKEY

- EN** Artery Forceps
- DE** Arterienklemmen
- ES** Pinzas hemostáticas

Page 117 to 157





- EN —● Haemostatic Forceps
- DE —● Arterienklemmen
- ES —● Pinzas hemostáticas



HALSTED-MOSQUITO

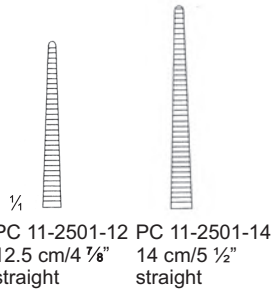

PC 11-2501-12 12.5 cm/4 1/8" straight  
 PC 11-2501-14 14 cm/5 1/2" straight

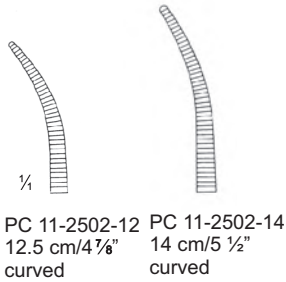

PC 11-2502-12 12.5 cm/4 1/8" curved  
 PC 11-2502-14 14 cm/5 1/2" curved



HALSTED-MOSQUITO

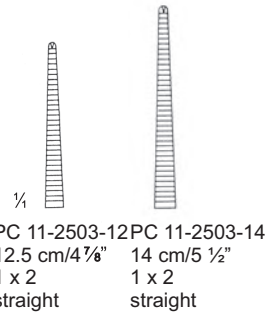

PC 11-2503-12 12.5 cm/4 1/8" 1 x 2 straight  
 PC 11-2503-14 14 cm/5 1/2" 1 x 2 straight

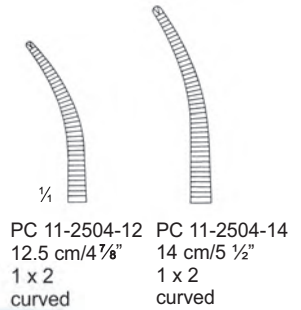

PC 11-2504-12 12.5 cm/4 1/8" 1 x 2 curved  
 PC 11-2504-14 14 cm/5 1/2" 1 x 2 curved



ATRAUMA

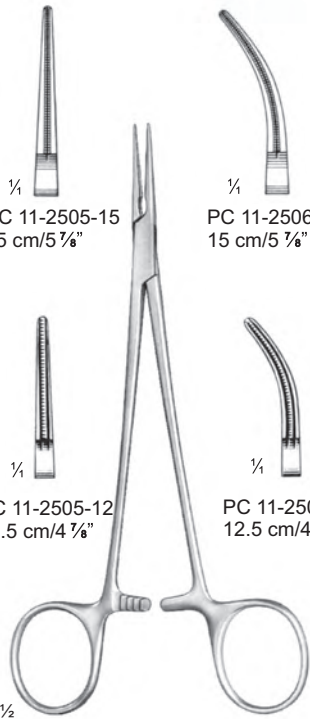

DEBAKEY-MOSQUITO

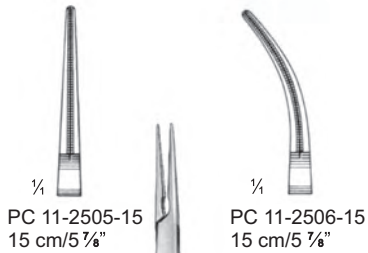

PC 11-2505-15 15 cm/5 7/8"  
 PC 11-2506-15 15 cm/5 7/8"

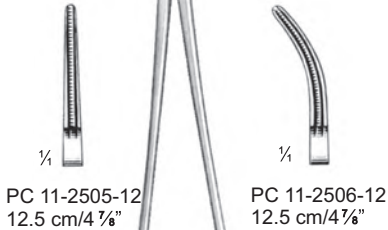

PC 11-2505-12 12.5 cm/4 1/8"  
 PC 11-2506-12 12.5 cm/4 1/8"



HALSTED-MOSQUITO

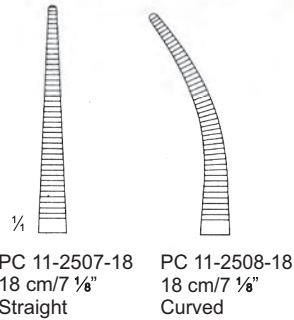

PC 11-2507-18 18 cm/7 1/8" Straight  
 PC 11-2508-18 18 cm/7 1/8" Curved

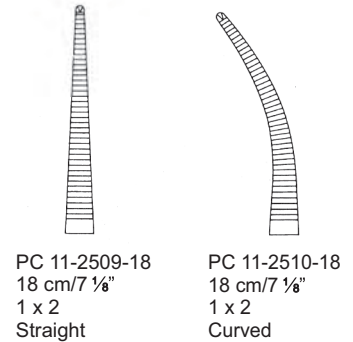

PC 11-2509-18 18 cm/7 1/8" 1 x 2 Straight  
 PC 11-2510-18 18 cm/7 1/8" 1 x 2 Curved

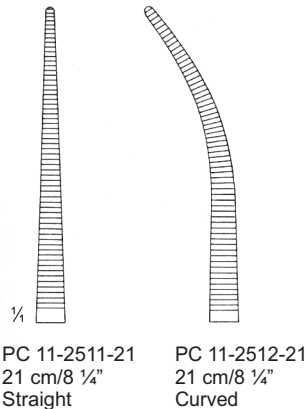

PC 11-2511-21 21 cm/8 1/4" Straight  
 PC 11-2512-21 21 cm/8 1/4" Curved

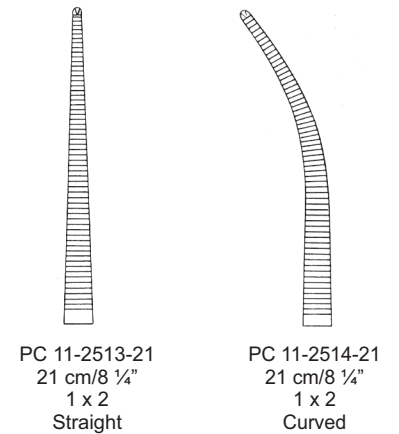

PC 11-2513-21 21 cm/8 1/4" 1 x 2 Straight  
 PC 11-2514-21 21 cm/8 1/4" 1 x 2 Curved

Haemostatic Forceps ●— EN  
 Arterienklemmen ●— DE  
 Pinzas hemostáticas ●— ES

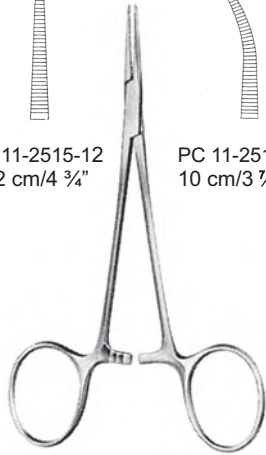
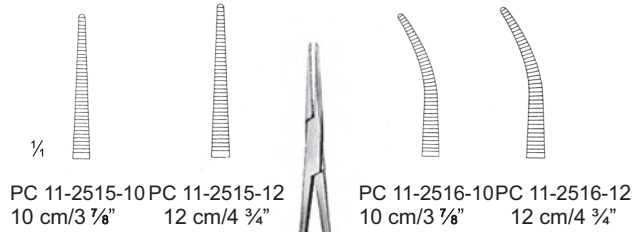

**MICRO-MOSQUITO**

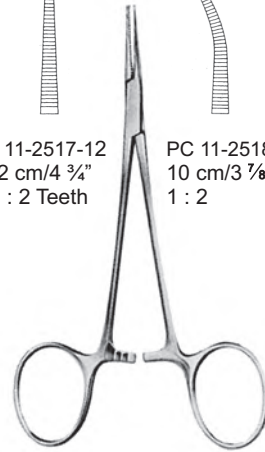
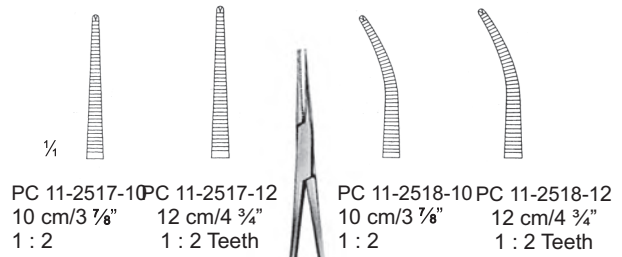

**MICRO-MOSQUITO**

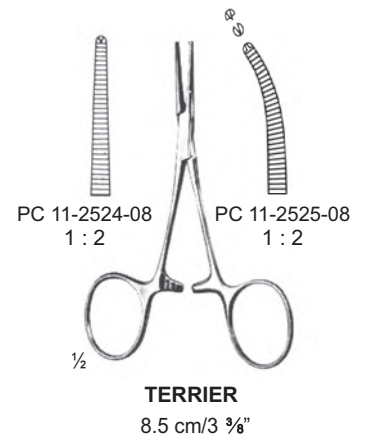
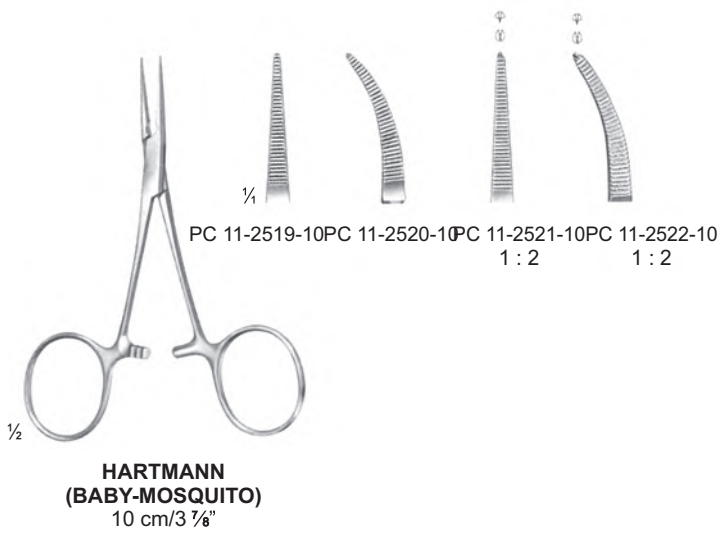

- EN —● Haemostatic Forceps
- DE —● Arterienklemmen
- ES —● Pinzas hemostáticas

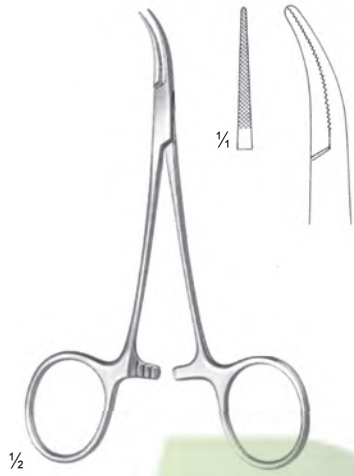

**MOSQUITO-DANDY**  
PC 11-2526-12  
12 cm/4 3/4"



**DANDY**  
14 cm/5 1/2"

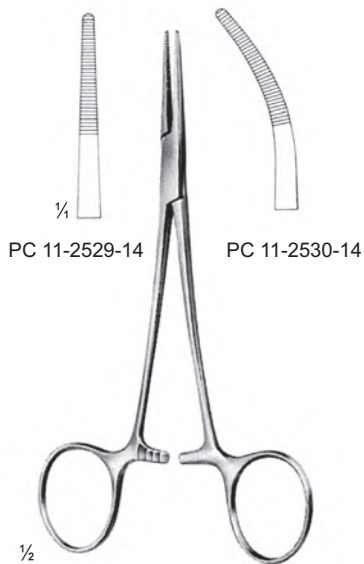
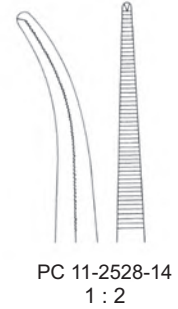
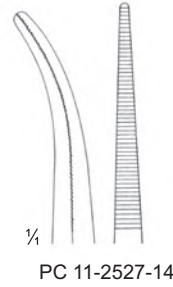

**PROVIDENCE-HOSPITAL**  
14 cm/5 1/2"

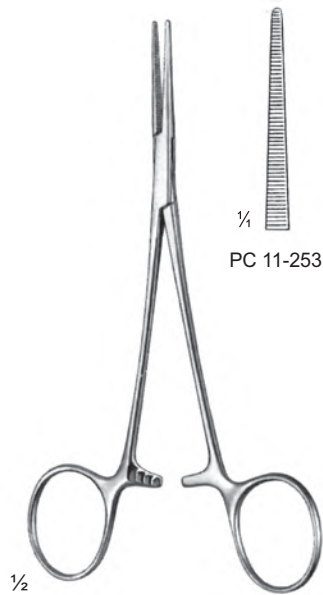

**LERICHE**  
15 cm/5 7/8"

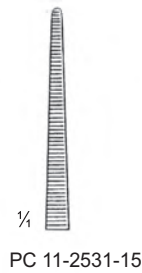

Haemostatic Forceps — EN  
 Arterienklemmen — DE  
 Pinzas hemostáticas — ES

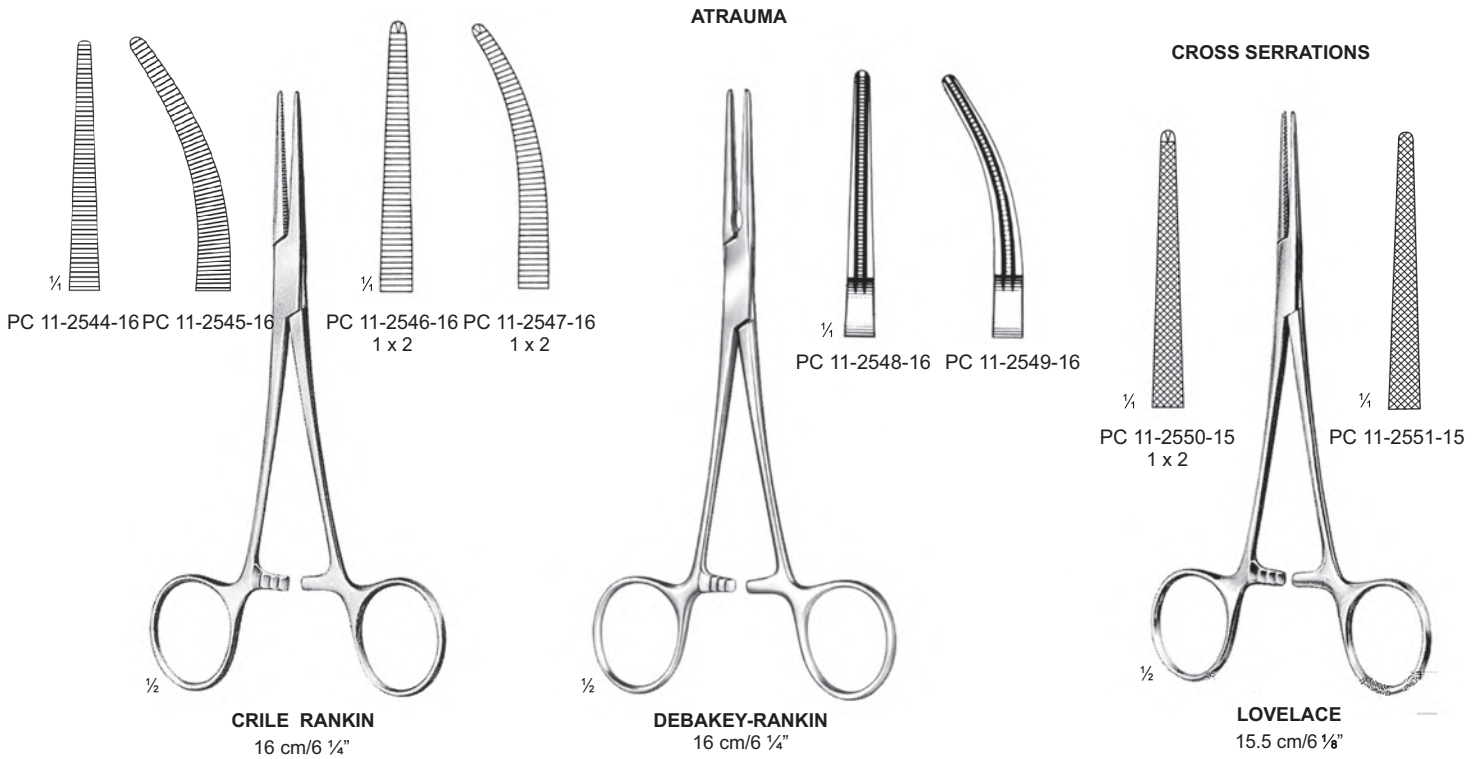
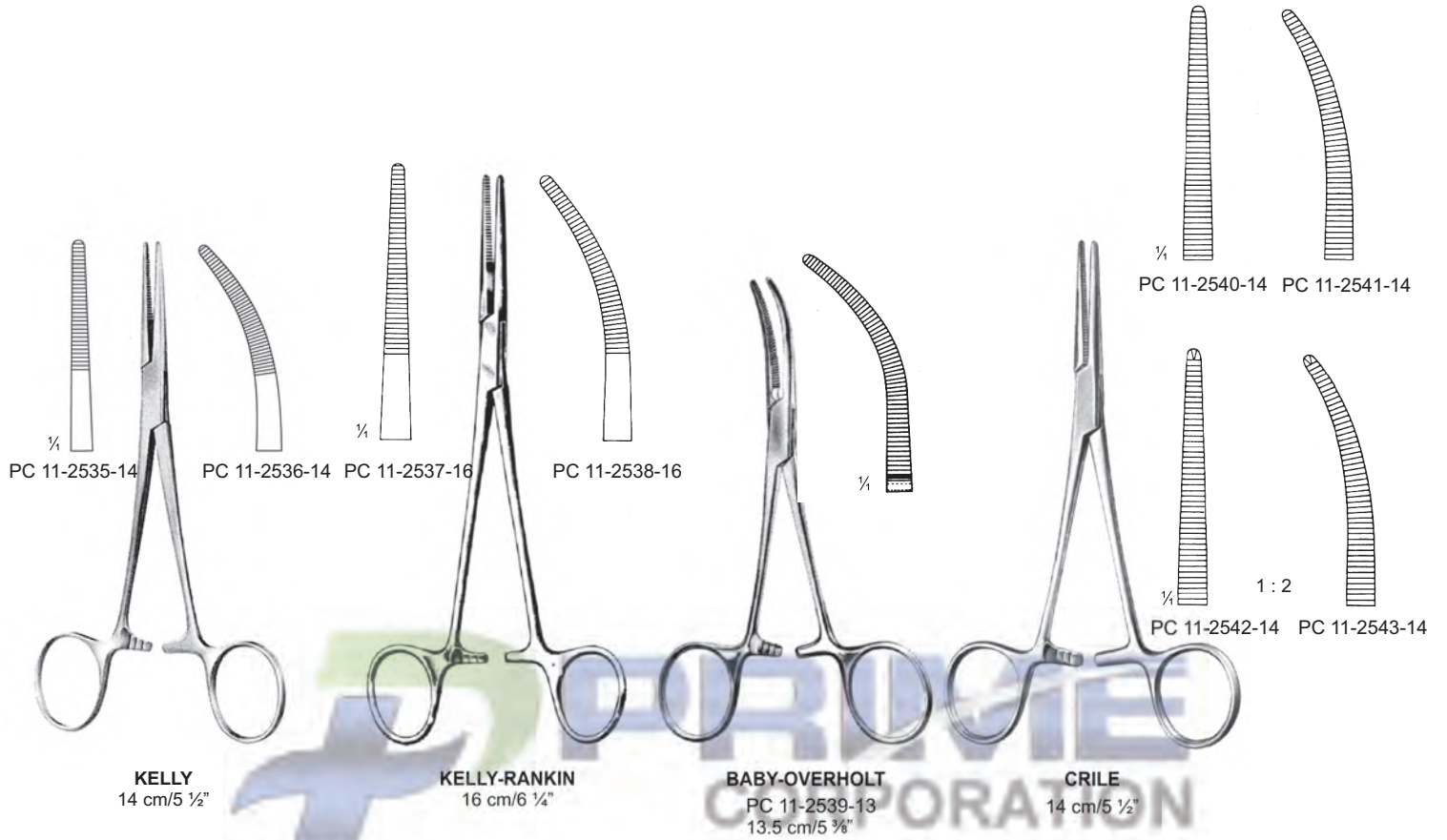



- EN —● Haemostatic Forceps
- DE —● Arterienklemmen
- ES —● Pinzas hemostáticas



**SPENCER-WELLS/JONES**

- |                               |                                 |                                 |                                 |                               |
|-------------------------------|---------------------------------|---------------------------------|---------------------------------|-------------------------------|
|                               |                                 |                                 |                                 |                               |
| PC 11-2552-13<br>13 cm/5 1/8" | PC 11-2552-14<br>14.5 cm/5 3/4" | PC 11-2552-15<br>15.5 cm/6 1/8" | PC 11-2552-18<br>18.5 cm/7 1/4" | PC 11-2552-20<br>20 cm/7 7/8" |

- |                               |                               |                               |                               |                               |
|-------------------------------|-------------------------------|-------------------------------|-------------------------------|-------------------------------|
|                               |                               |                               |                               |                               |
| PC 11-2553-13<br>13 cm/5 1/8" | PC 11-2553-14<br>14 cm/5 1/2" | PC 11-2553-15<br>15 cm/5 7/8" | PC 11-2553-18<br>18 cm/7 1/8" | PC 11-2553-20<br>20 cm/7 7/8" |

- |                                 |                                 |                               |
|---------------------------------|---------------------------------|-------------------------------|
|                                 |                                 |                               |
| PC 11-2554-13<br>13.5 cm/5 3/8" | PC 11-2554-14<br>14.5 cm/5 3/4" | PC 11-2554-17<br>17 cm/6 3/4" |

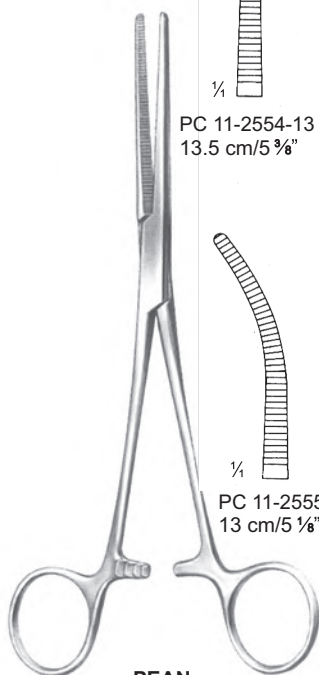

**PEAN  
DELICATE PATTERN**

- |                               |                               |                                 |
|-------------------------------|-------------------------------|---------------------------------|
|                               |                               |                                 |
| PC 11-2555-13<br>13 cm/5 1/8" | PC 11-2555-14<br>14 cm/5 1/2" | PC 11-2555-16<br>16.5 cm/6 1/2" |

Cm	In	Straight
18	7 1/8"	PC 11-2557-18
20	7 7/8"	PC 11-2557-20
22	8 1/2"	PC 11-2557-22
24	9 1/2"	PC 11-2557-24
26	10 1/4"	PC 11-2557-26
28	11"	PC 11-2557-28

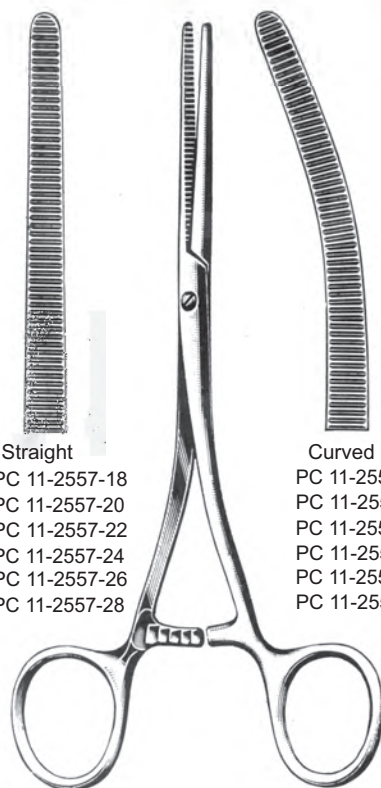

**PEAN**

Curved
PC 11-2558-18
PC 11-2558-20
PC 11-2558-22
PC 11-2558-24
PC 11-2558-26
PC 11-2558-28

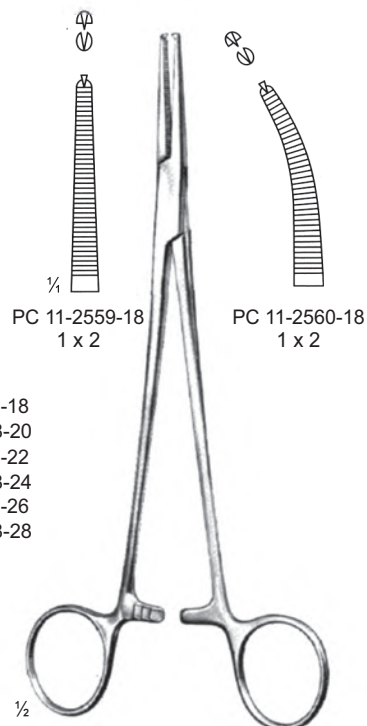

**ADSON  
18.5 cm/7 1/4"**

Haemostatic Forceps ●— EN  
 Arterienklemmen ●— DE  
 Pinzas hemostáticas ●— ES

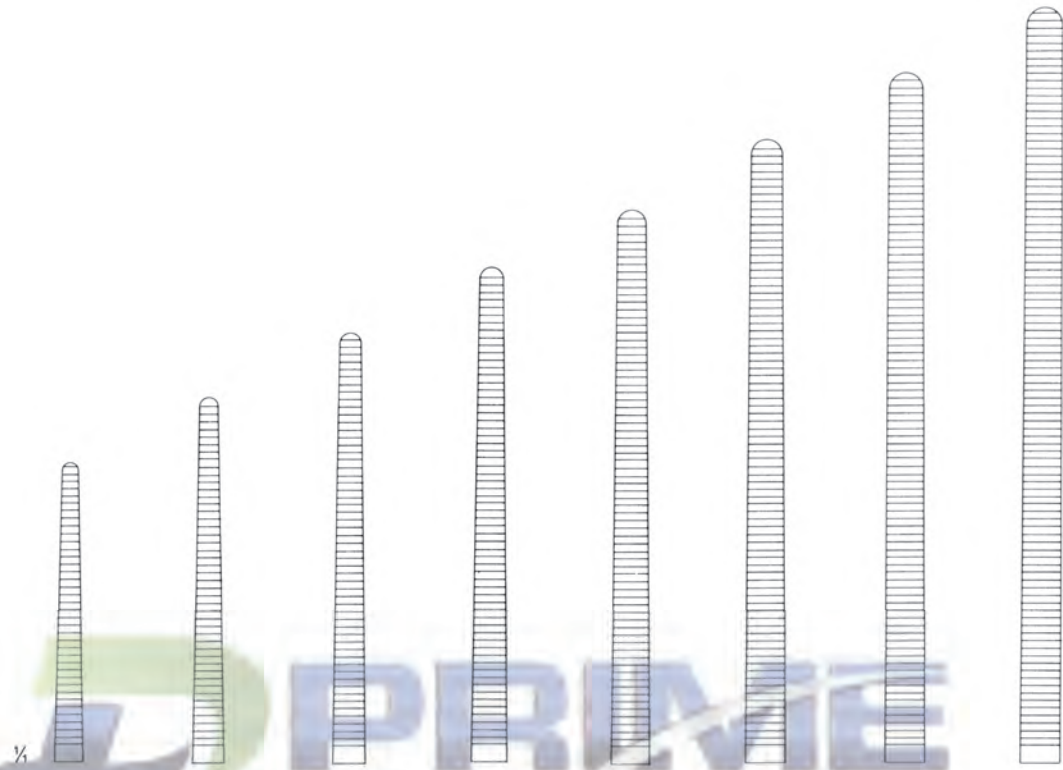

PC 11-2561-14 PC 11-2561-16 PC 11-2561-18 PC 11-2561-20 PC 11-2561-22 PC 11-2561-24 PC 11-2561-26 PC 11-2561-30  
 14.5 cm/5 3/4" 16.5 cm/6 1/2" 18.5 cm/7 1/4" 20.5 cm/8 1/8" 22.5 cm/8 3/4" 24.5 cm/9 5/8" 26 cm/10 1/4" 30.5 cm/12"



ROCHESTER-PEAN

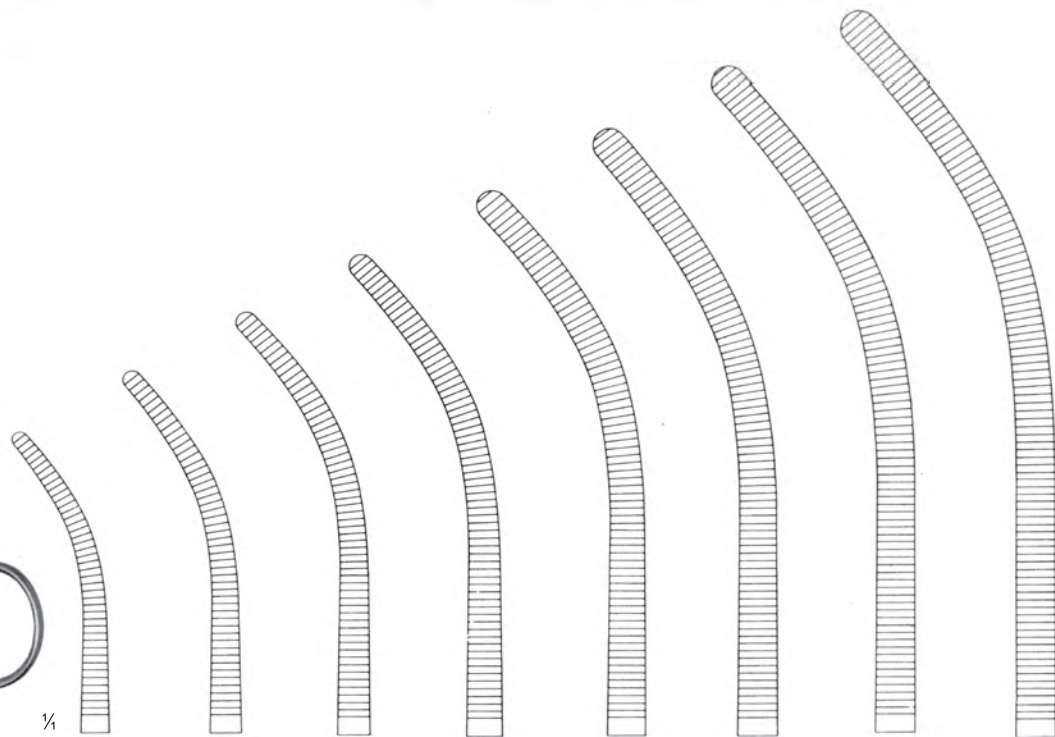

PC 11-2562-14 PC 11-2562-16 PC 11-2562-18 PC 11-2562-20 PC 11-2562-22 PC 11-2562-24 PC 11-2562-26 PC 11-2562-30  
 14.5 cm/5 3/4" 16.5 cm/6 1/2" 18.5 cm/7 1/4" 20.5 cm/8 1/8" 22.5 cm/8 3/4" 24.5 cm/9 5/8" 26 cm/10 1/4" 30.5 cm/12"



- EN —● Haemostatic Forceps
- DE —● Arterienklemmen
- ES —● Pinzas hemostáticas

**ATRAUMA**



**DEBAKEY-PEAN**

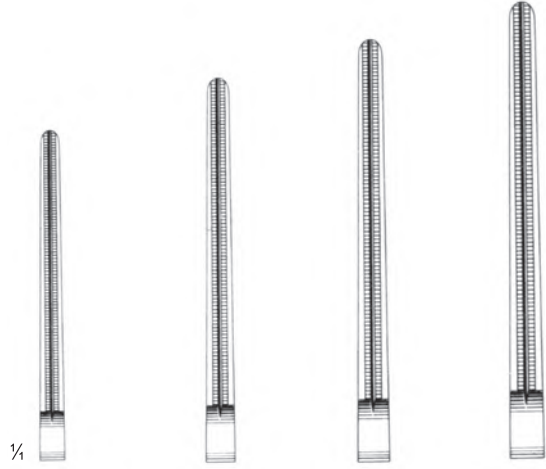

- PC 11-2563-14 14.5 cm/5 3/4"
- PC 11-2563-16 16.5 cm/6 1/2"
- PC 11-2563-18 18.5 cm/7 1/4"
- PC 11-2563-20 20.5 cm/8 1/8"



**DEBAKEY-PEAN**



- PC 11-2564-14 14.5 cm/5 3/4"
- PC 11-2564-16 16.5 cm/6 1/2"
- PC 11-2564-18 18.5 cm/7 1/4"
- PC 11-2564-20 20.5 cm/8 1/8"

Haemostatic Forceps ●— EN  
 Arterienklemmen ●— DE  
 Pinzas hemostáticas ●— ES

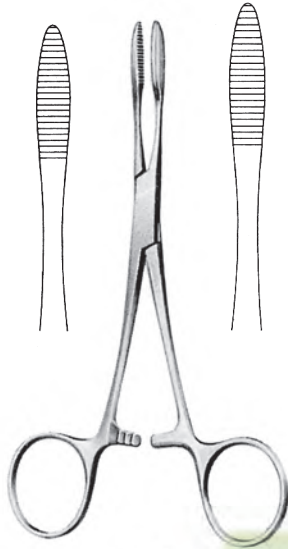

**PEAN**  
 PC 11-2565-14 14 cm/5 1/2"  
 PC 11-2565-16 16 cm/6 1/4"



**KOCHER**  
 Delicate Pattern  
 1 : 2

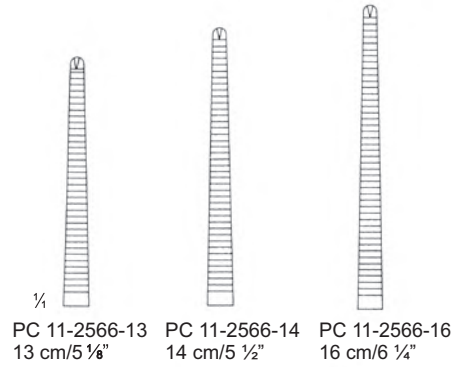

PC 11-2566-13 13 cm/5 1/8"  
 PC 11-2566-14 14 cm/5 1/2"  
 PC 11-2566-16 16 cm/6 1/4"

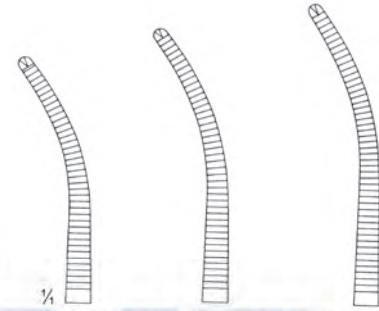

PC 11-2567-13 13 cm/5 1/8"  
 PC 11-2567-14 14 cm/5 1/2"  
 PC 11-2567-16 16 cm/6 1/4"



**KOCHER**

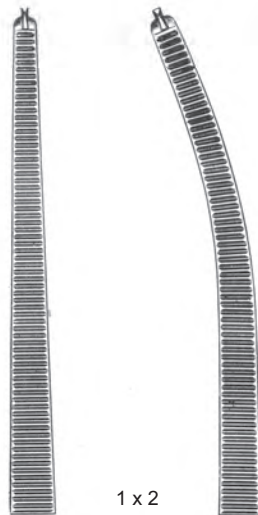

1 x 2

PC 11-2568-18 18 cm/7 1/8"  
 PC 11-2568-20 20 cm/7 7/8"  
 PC 11-2568-22 22 cm/8 1/2"  
 PC 11-2568-24 24 cm/9 1/2"  
 PC 11-2568-26 26 cm/10 1/4"



1 x 2

**KOCHER (STANDARD)**

PC 11-2570-13 13 cm/5 1/8"  
 PC 11-2570-14 14 cm/5 1/2"  
 PC 11-2571-14 14.5cm/5 3/4"

PC 11-2572-13  
 PC 11-2572-14  
 PC 11-2573-14



- EN —● Haemostatic Forceps
- DE —● Arterienklemmen
- ES —● Pinzas hemostáticas



PC 11-2574-16 16 cm/6 1/4"    PC 11-2574-18 18 cm/7 1/8"    PC 11-2574-20 20 cm/7 7/8"    PC 11-2574-22 22 cm/8 1/2"    PC 11-2574-24 24 cm/9 1/2"    PC 11-2574-26 26 cm/10 1/4"    PC 11-2574-28 28 cm/11"    PC 11-2574-30 30 cm/11 3/4"



**KOCHER OCHSNER**  
1 : 2

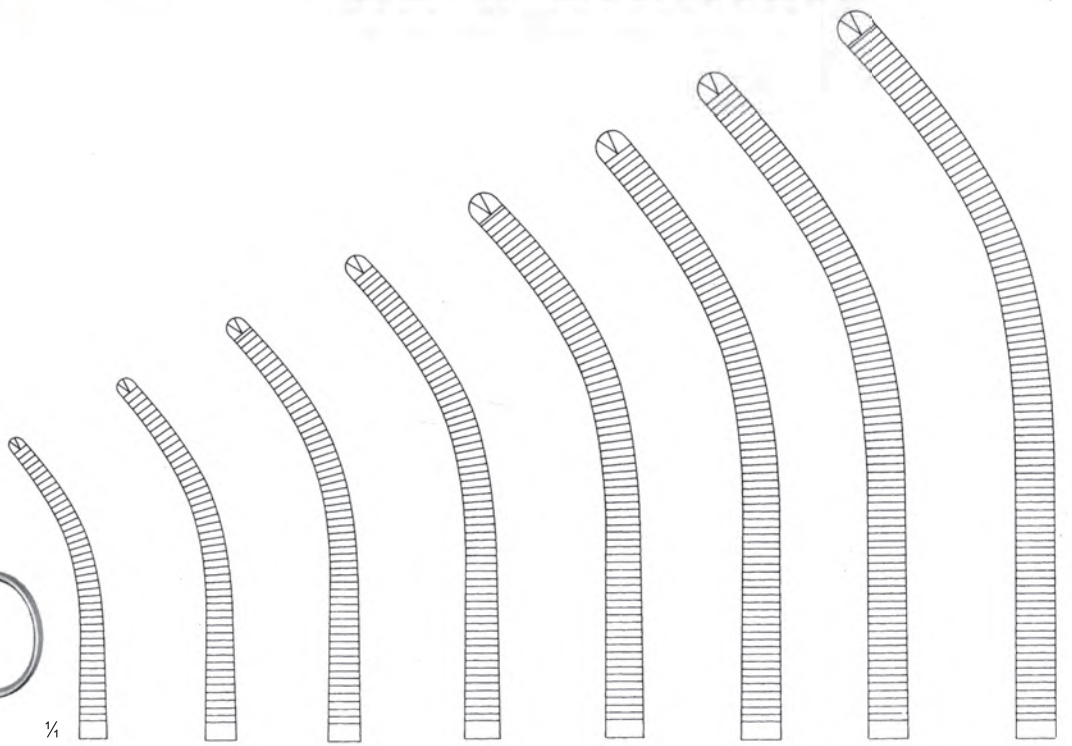

PC 11-2575-16 16 cm/6 1/4"    PC 11-2575-18 18 cm/7 1/8"    PC 11-2575-20 20 cm/7 7/8"    PC 11-2575-22 22 cm/8 1/2"    PC 11-2575-24 24 cm/9 1/2"    PC 11-2575-26 26 cm/10 1/4"    PC 11-2575-28 28 cm/11"    PC 11-2575-30 30 cm/11 3/4"

Organ Grasping Forceps, Haemostatic Forceps — EN  
 Organfasszangen, Arterienklemmen — DE  
 Pinzas para sacar órganos, Pinzas hemostáticas — ES

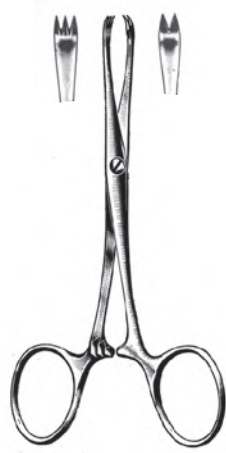

**CHAPUT**  
 PC 11-2576-13  
 13 cm/5 1/8"

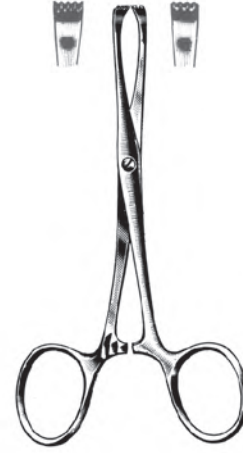

**TUFFIER**  
 PC 11-2577-13  
 13 cm/5 1/8"

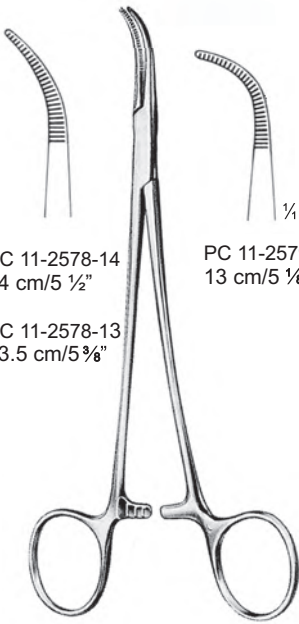

PC 11-2578-14  
 14 cm/5 1/2"

PC 11-2578-13  
 13.5 cm/5 3/8"

**BABY-MIXTER**

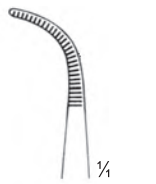

PC 11-2579-13  
 13 cm/5 1/8"

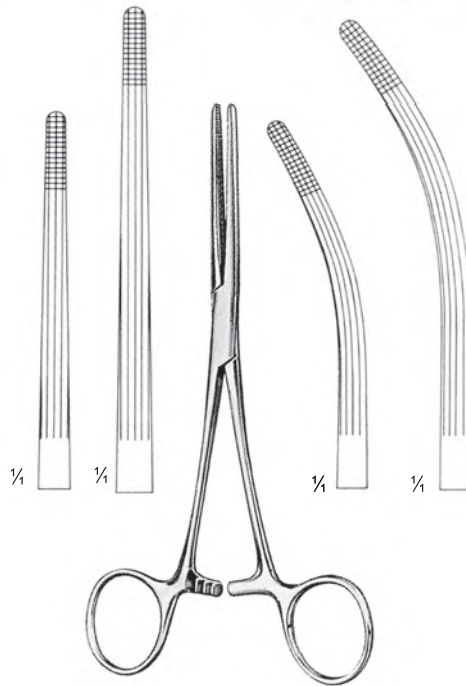

**ROCHESTER-CARMALT**  
 PC 11-2580-16 16 cm/6 1/4" PC 11-2581-16  
 PC 11-2580-20 20 cm/7 7/8" PC 11-2581-20

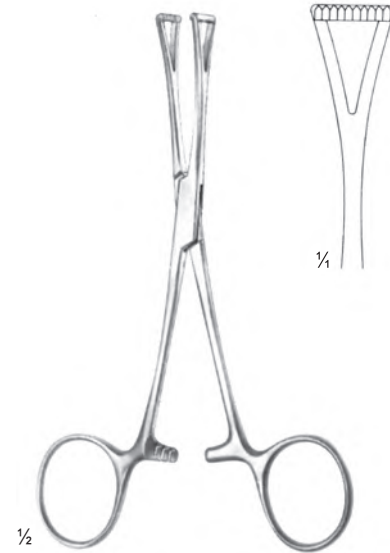

**COLLIN**  
 PC 11-2582-14  
 14 cm/5 1/2"

- EN —● Haemostatic Forceps
- DE —● Arterienklemmen
- ES —● Pinzas hemostáticas



**BIRKET**  
18.5 cm/7 ¼"

PC 11-2583-18 PC 11-2584-18

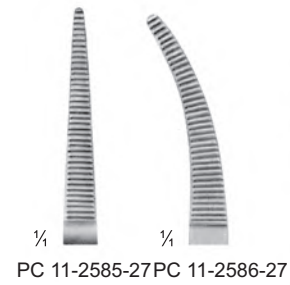

PC 11-2585-27 PC 11-2586-27



**BRIDGE**  
27.5 cm/10 ¾"



**BENGOLEA**

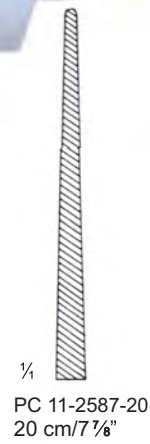

PC 11-2587-20  
20 cm/7 7/8"



PC 11-2588-20  
20 cm/7 7/8"



PC 11-2591-20  
20 cm/7 7/8"  
1 : 2



PC 11-2592-20  
20 cm/7 7/8"  
1 : 2



PC 11-2589-26  
26 cm/10 ¼"



PC 11-2590-26  
26 cm/10 ¼"



PC 11-2593-26  
26 cm/10 ¼"  
1 : 2



PC 11-2594-26  
26 cm/10 ¼"  
1 : 2



Pressure Clamps, Haemorrhoidal Clamps ●— EN

Druckklemmen, Hämorrhoidenklemmen ●— DE

Pinza-Clamp de presión progresiva, Pinza-Clamps para hemorroides ●— ES

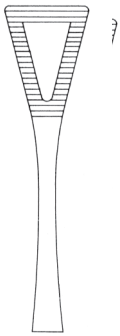

**PENNINGTON**

PC 11-2595-15 15.5 cm/6<sup>1</sup>/<sub>8</sub>"  
PC 11-2595-20 20 cm/7<sup>7</sup>/<sub>8</sub>"



**PRATT**

PC 11-2596-15  
15 cm/5<sup>7</sup>/<sub>8</sub>"

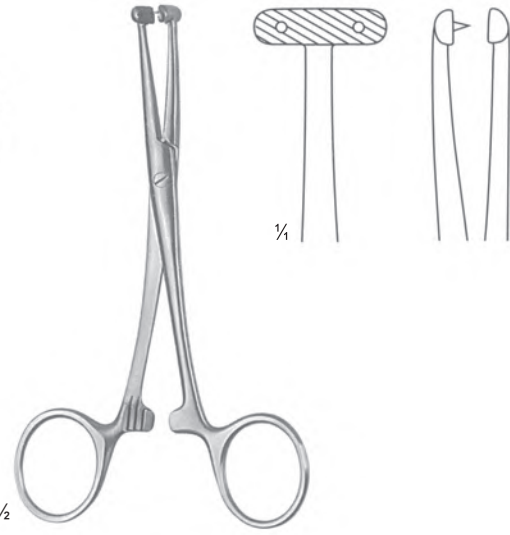

**MARTEL**

PC 11-2597-14  
14 cm/5<sup>1</sup>/<sub>2</sub>"



**WILLET-MARTEL**

PC 11-2598-19  
19 cm/7<sup>1</sup>/<sub>2</sub>"



**BUIE**

PC 11-2599-21  
21 cm/8<sup>1</sup>/<sub>4</sub>"

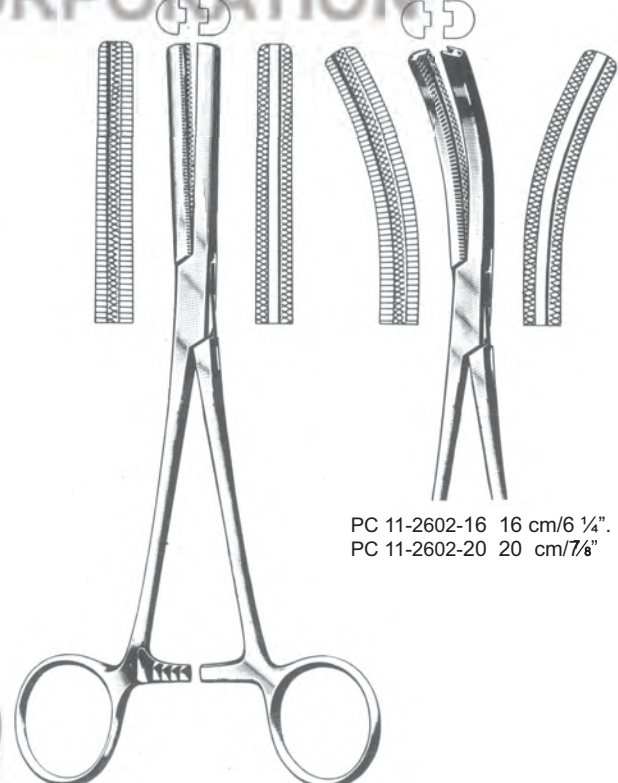

**FERGUSSON**

PC 11-2600-16 16 cm/6<sup>1</sup>/<sub>4</sub>"  
PC 11-2600-20 20 cm/7<sup>7</sup>/<sub>8</sub>"

PC 11-2602-16 16 cm/6<sup>1</sup>/<sub>4</sub>"  
PC 11-2602-20 20 cm/7<sup>7</sup>/<sub>8</sub>"



- EN —● Tissue Grasping & Haemostatic Forceps
- DE —● Gewebfaßzangen, Arterienklemmen
- ES —● Pinzas para tejidos, Pinzas hemostáticas

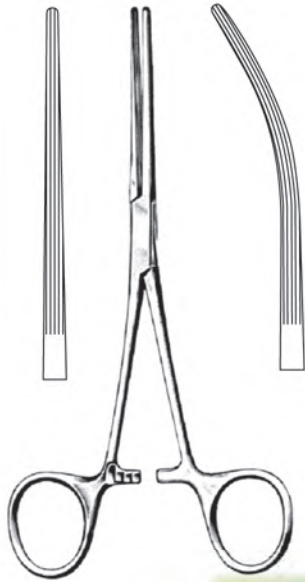

**BAINBRIDGE**

PC 11-2603-15 15 cm/5 7/8" PC 11-2604-15  
 PC 11-2603-18 18.5 cm/7 1/4" PC 11-2604-18

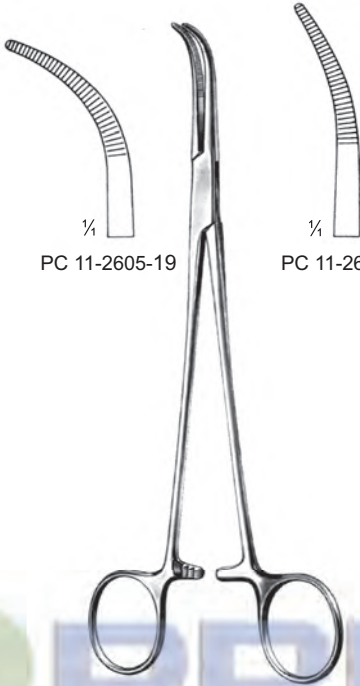

**SCHNIDT**

19 cm/7 1/2"

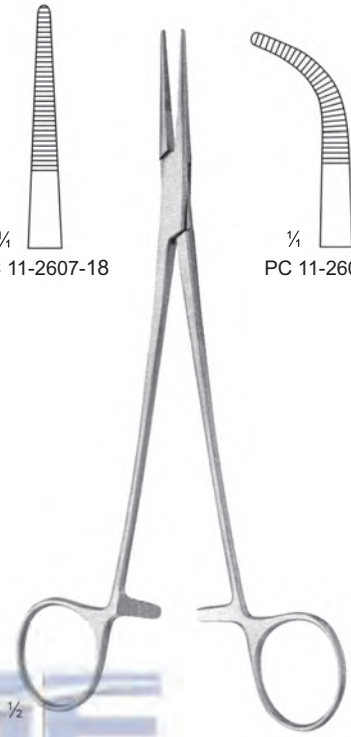

**ADSON**

18.5 cm/7 1/4"

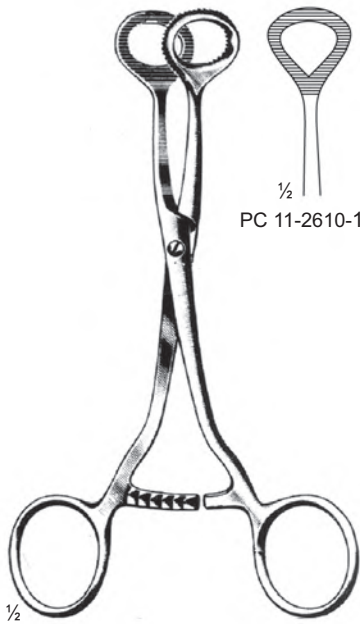

**COLLIN**

PC 11-2609-16  
 16 cm/6 1/4"

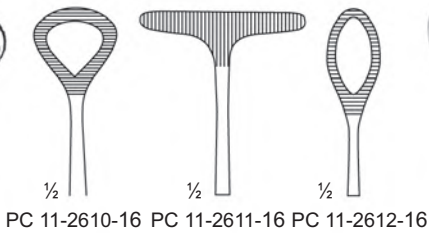

**COLLIN**

PC 11-2613-16  
 16.5 cm/6 1/2"

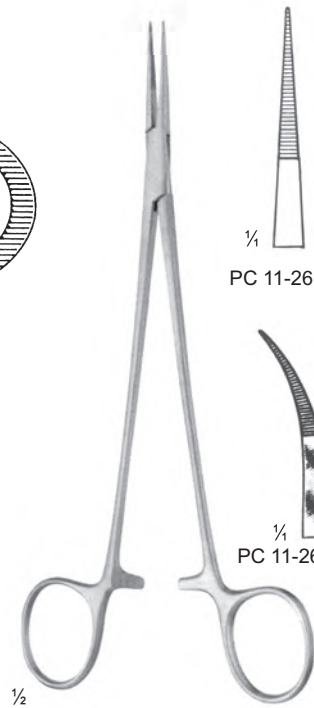

**JACOBSON-MICRO**

18 cm/7 1/8"

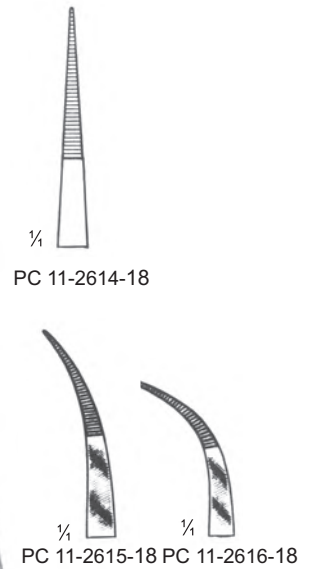

Dissecting and Ligature Forceps — EN  
 Präparierklemmen — DE  
 Pinzas para preparación y ligadura — ES



**BABY-MIXTER**  
 PC 11-2617-18  
 18 cm/7 1/8"



**MICRO-ADSON**  
 PC 11-2618-14  
 14 cm/5 1/2"

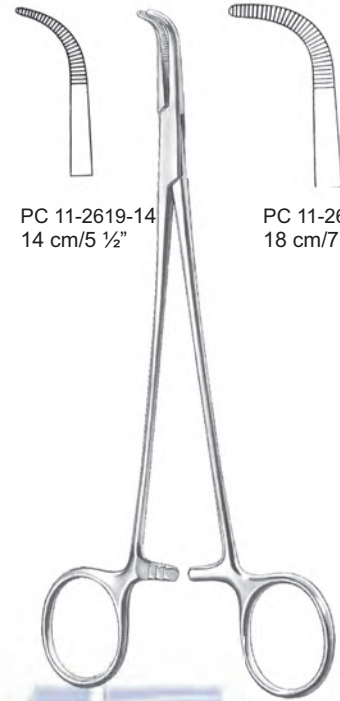

PC 11-2619-14  
 14 cm/5 1/2"

PC 11-2619-18  
 18 cm/7 1/8"

**ADSON-BABY**

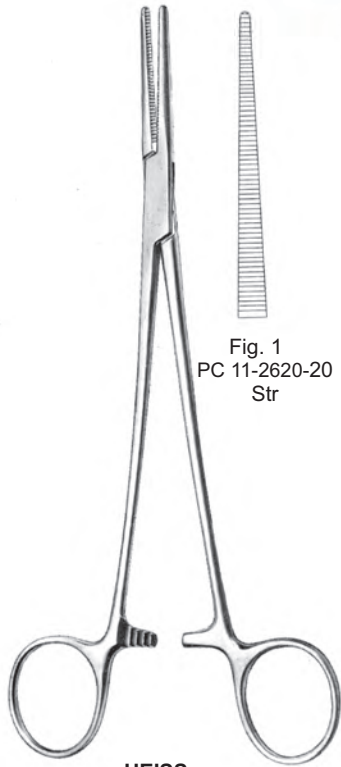
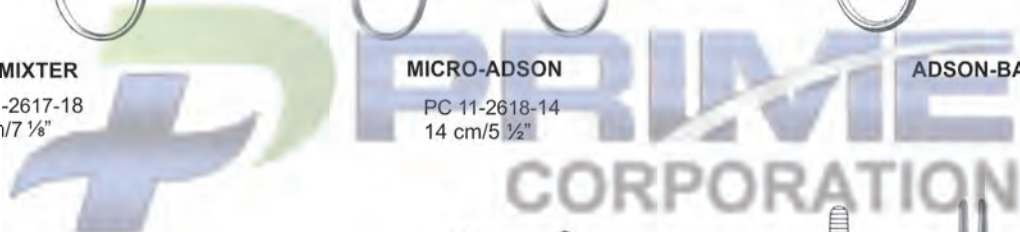

**HEISS**  
 20 cm/7 7/8"

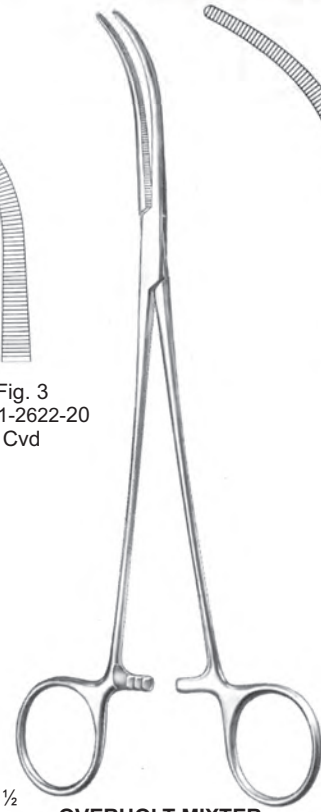
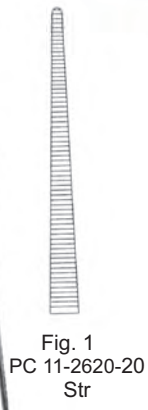

**OVERHOLT-MIXTER**  
 PC 11-2623-21  
 21 cm/8 1/4"

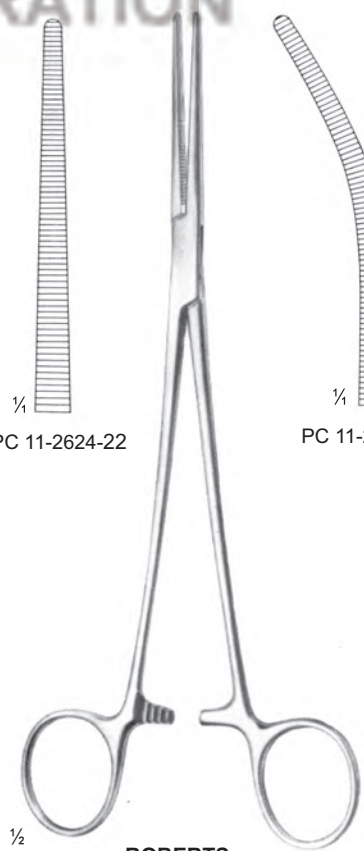
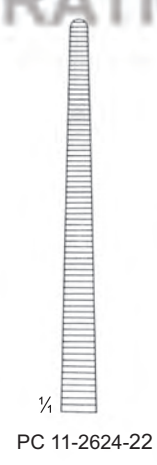

**ROBERTS**  
 22 cm/8 1/2"

- EN —● Dissecting and Ligature Forceps, Bile Duct Clamps
- DE —● Präparierklemmen, Gallenkanalklemmen
- ES —● Pinzas para preparación y ligadura, Pinzas para conducto biliar

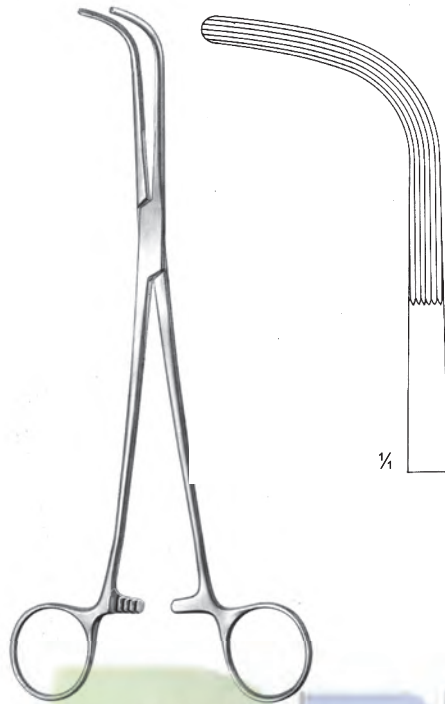

**MCQUIGG-MIXTER**  
PC 11-2626-23  
23.5 cm/9 1/4"

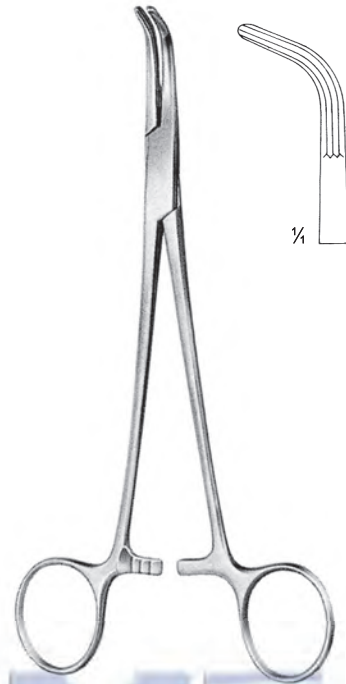

**LAHEY**  
PC 11-2627-18  
18.5 cm/7 1/4"



**LAHEY**



PC 11-2628-19  
19.5 cm/7 1/2"

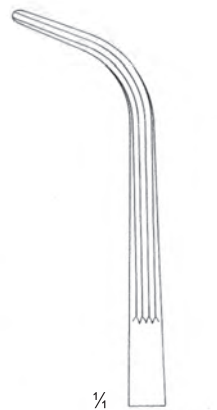

PC 11-2629-22  
22.5 cm/8 3/4"

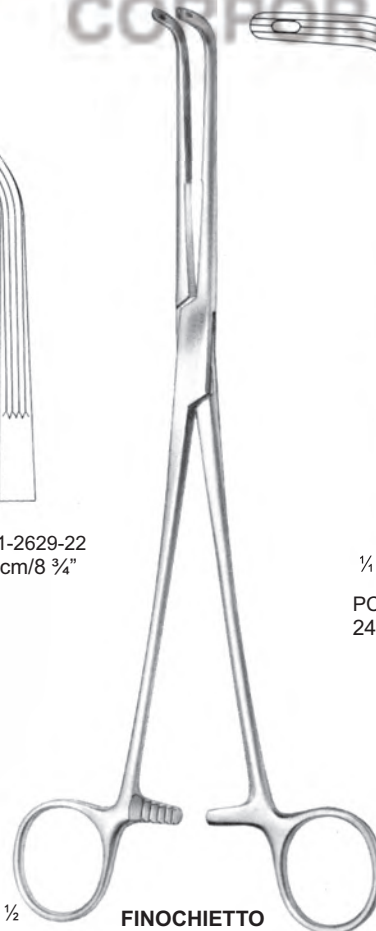

**FINOCHIETTO**



PC 11-2630-24  
24.5 cm/9 5/8"



**MIXTER-BABY**  
PC 11-2631-14  
14 cm/5 1/2"

Dissecting and Ligature Forceps ●— EN  
 Präparierklemmen ●— DE  
 Pinzas para preparación y ligadura ●— ES



**KELLY**

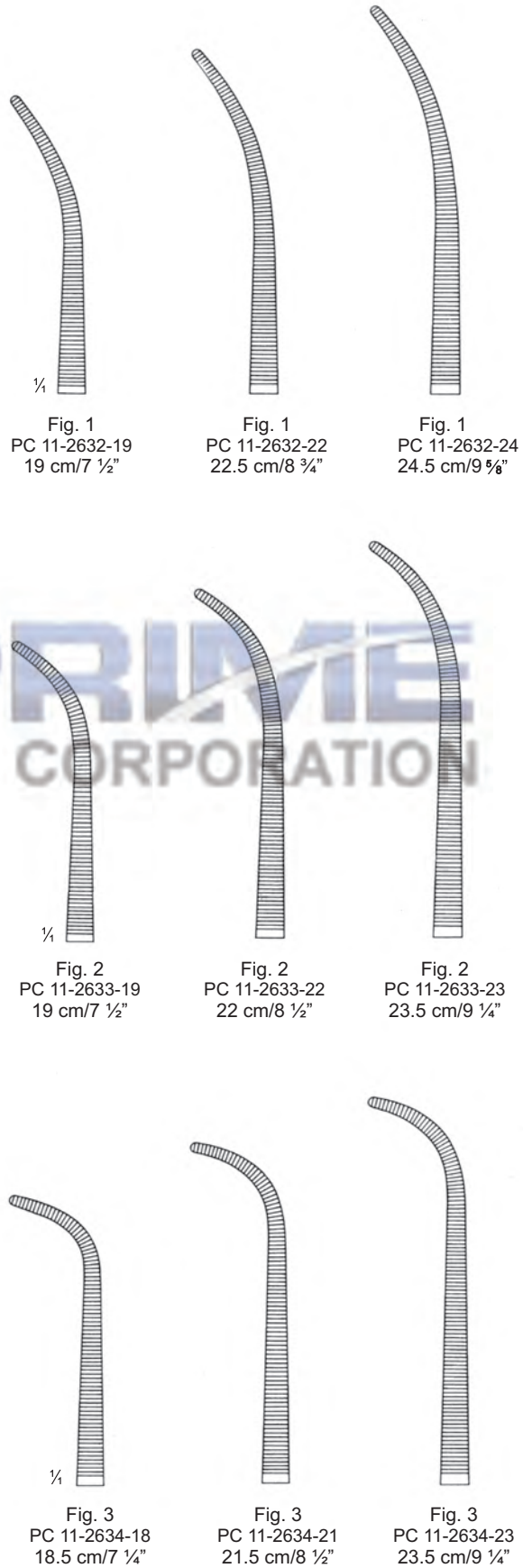



- EN —● Dissecting and Ligature Forceps
- DE —● Präparierklemmen
- ES —● Pinzas para preparación y ligadura



**LAWRENCE**  
PC 11-2635-28  
28 cm/11"



**WIKSTROEM**



PC 11-2636-21  
21 cm/8 1/4"



PC 11-2636-24  
24.5 cm/9 5/8"



**MEEKER**  
PC 11-2637-28  
28 cm/11"



**MIXTER-CRAFOORD**  
PC 11-2638-25 25 cm/9 7/8"  
PC 11-2638-27 27 cm/10 1/2"

Dissecting and Ligature Forceps ●— EN  
 Präparierklemmen ●— DE  
 Pinzas para preparación y ligadura ●— ES



MINI-GEMINI

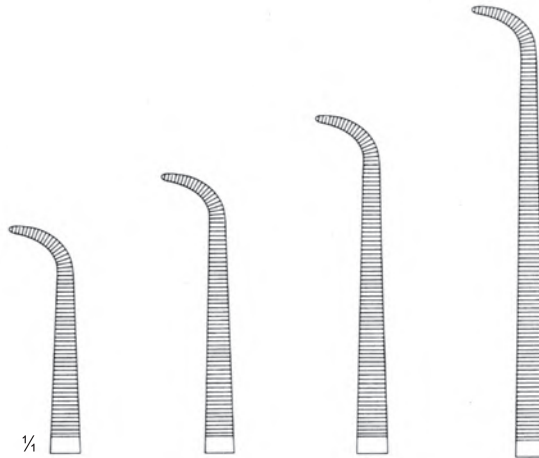

PC 11-2639-18	PC 11-2639-22	PC 11-2639-25	PC 11-2639-28
18 cm/7 1/8"	22.5 cm/8 3/4"	25 cm/9 7/8"	28.5 cm/11 1/4"



GEMINI

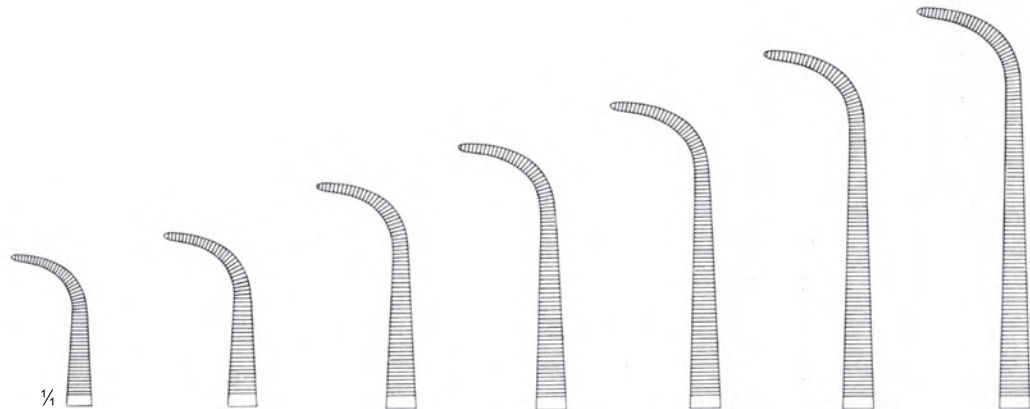

PC 11-2640-13	PC 11-2640-16	PC 11-2640-18	PC 11-2640-21	PC 11-2640-23	PC 11-2640-25	PC 11-2640-28
13 cm/5 1/8"	16 cm/6 1/4"	18 cm/7 1/8"	21 cm/8 1/4"	23 cm/9"	25 cm/9 7/8"	28 cm/11"

- EN —● Dissecting and Ligature Forceps
- DE —● Präparierklemmen
- ES —● Pinzas para preparación y ligadura

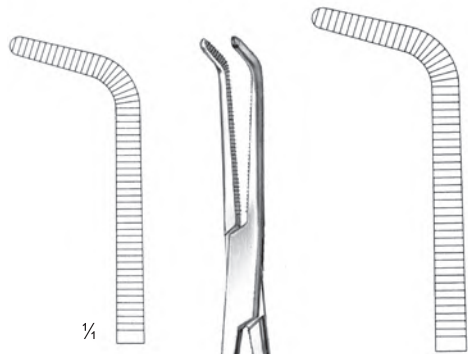

1/4

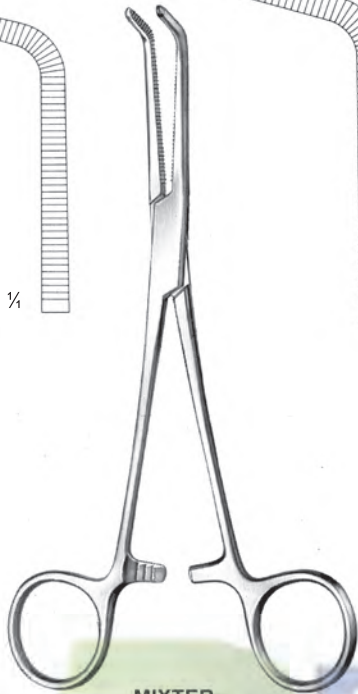

**MIXTER**

- PC 11-2641-14 14.5 cm/5 3/4"
- PC 11-2641-15 15.5 cm/6 1/8"
- PC 11-2641-19 19 cm/7 1/2"

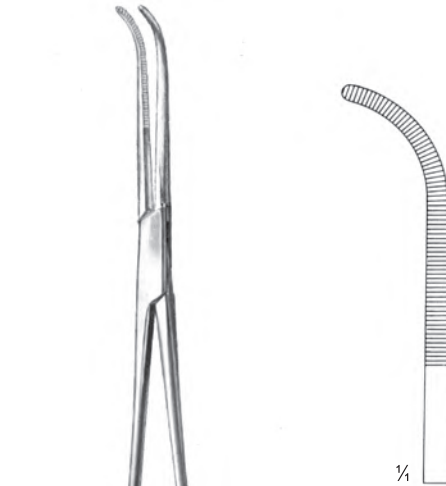

1/4



1/2

**MIXTER**

- PC 11-2642-22
- 22 cm/8 1/2"

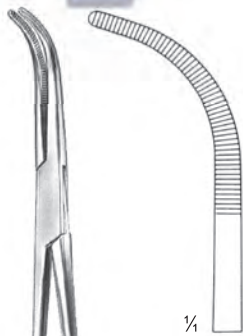

1/4



1/2

**MIXTER**

- PC 11-2643-23
- 23 cm/9"

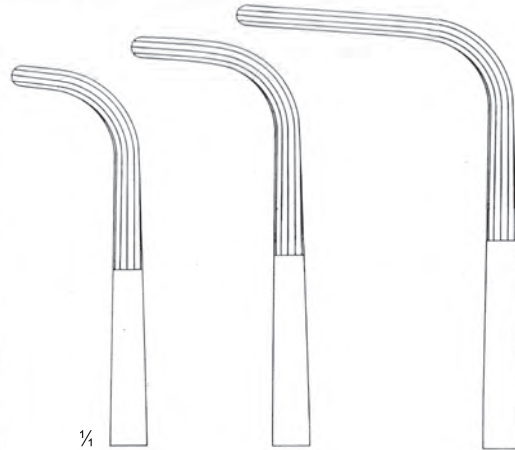

1/4

Fig. 1

- PC 11-2644-22
- 22 cm/8 1/2"

2

- PC 11-2644-25
- 25 cm/9 7/8"

3

- PC 11-2644-28
- 28 cm/11"

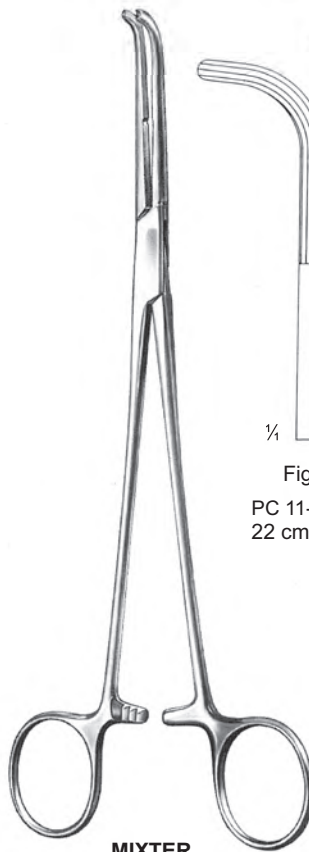

**MIXTER**

Dissecting and Ligature Forceps ● EN  
 Präparierklemmen ● DE  
 Pinzas para preparación y ligadura ● ES

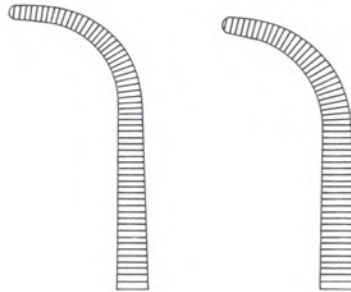

PC 11-2645-15  
15 cm/5 7/8"

PC 11-2645-18  
18 cm/7 1/8"



PC 11-2645-19  
18.5 cm/7 1/4"

PC 11-2645-20  
20 cm/7 7/8"

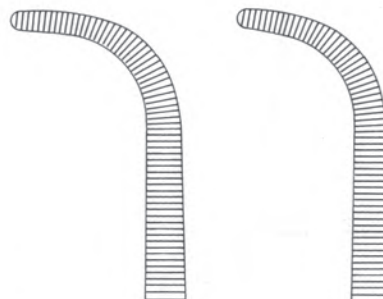

PC 11-2645-23  
23 cm/9"

PC 11-2645-26  
26 cm/10 1/4"



O'SHAUGNESSY



- EN —● Dissecting and Ligature Forceps
- DE —● Präparierklemmen
- ES —● Pinzas para preparación y ligadura

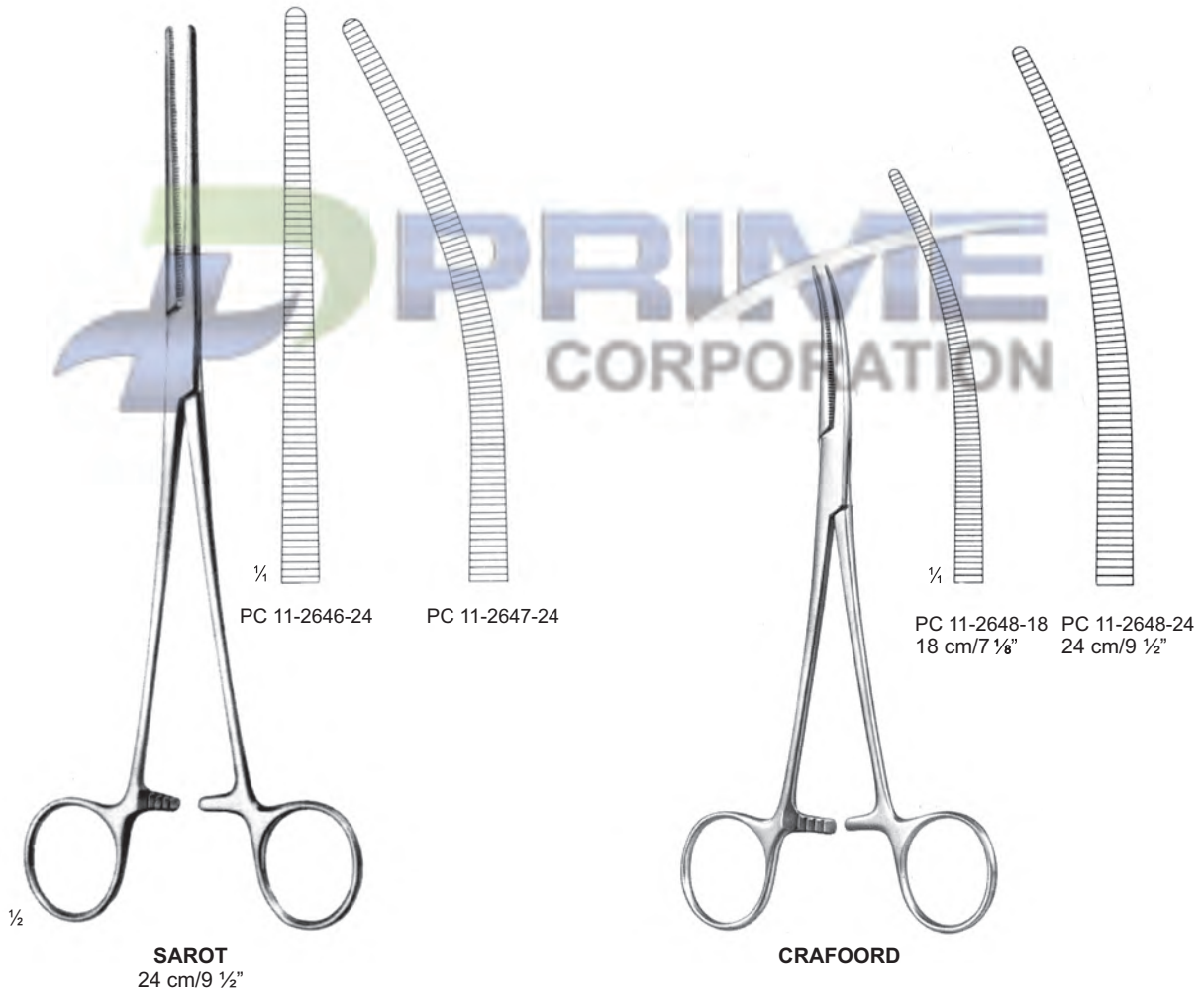

Dissecting and Ligature Forceps ●— EN  
 Präparierklemmen ●— DE  
 Pinzas para preparación y ligadura ●— ES

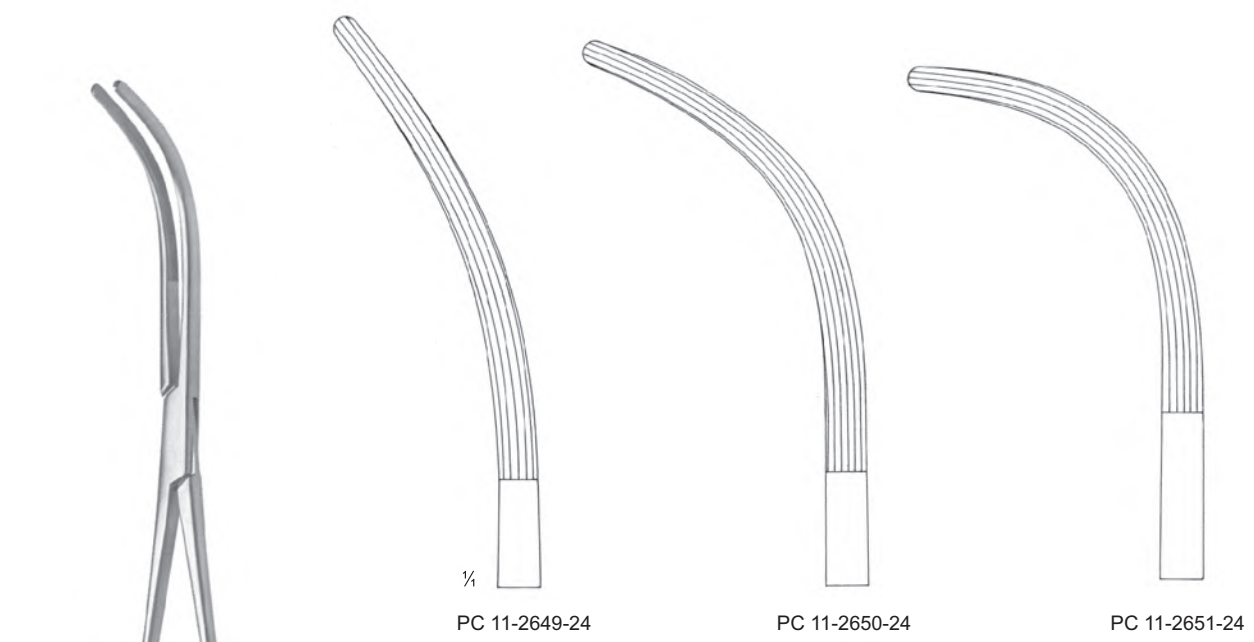

**CRAFOORD-SELLORS**  
 24 cm/9 1/2"  
 Vascular Clamp

PC 11-2649-24

PC 11-2650-24

PC 11-2651-24

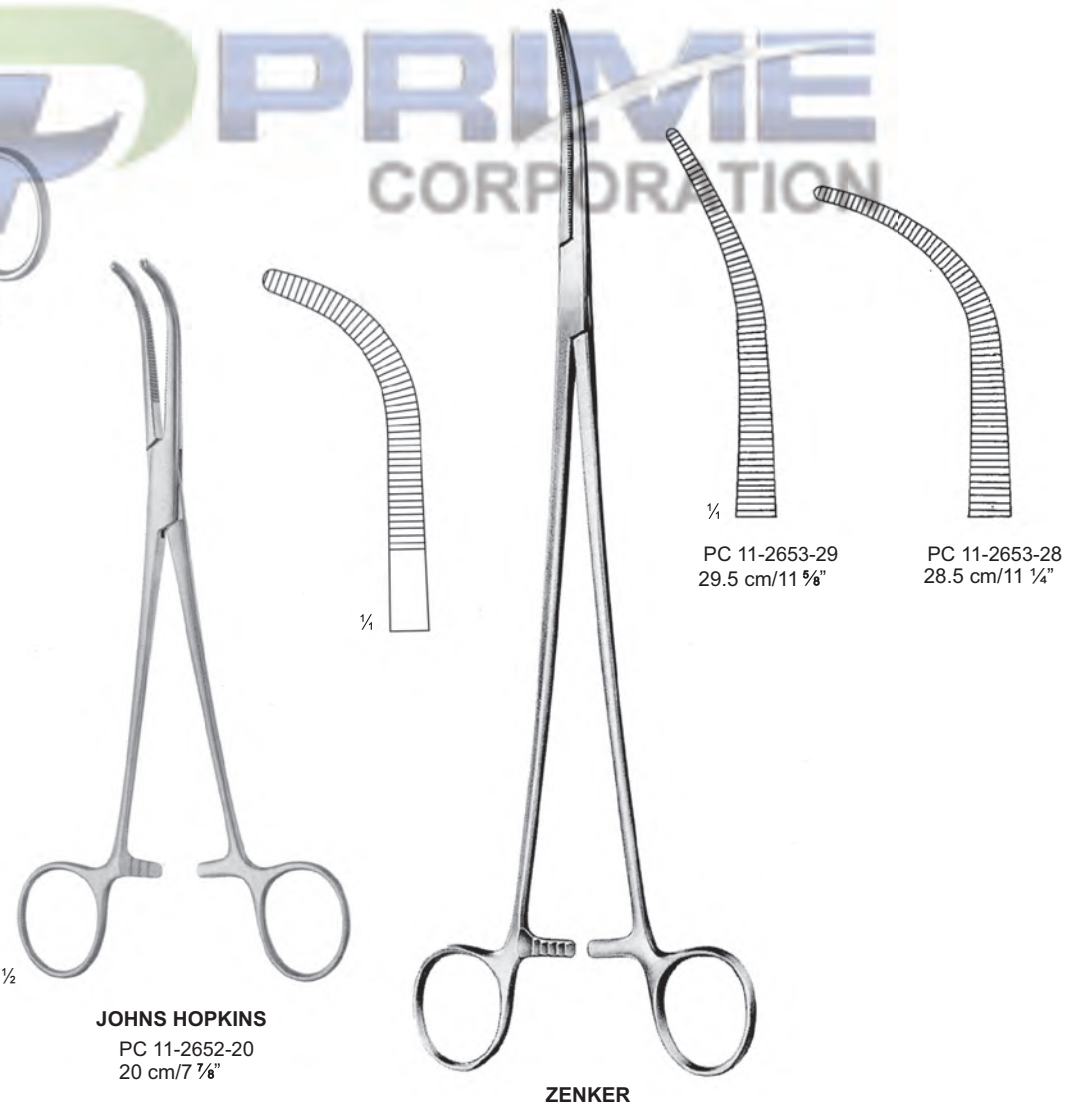

**JOHNS HOPKINS**  
 PC 11-2652-20  
 20 cm/7 7/8"

**ZENKER**

PC 11-2653-29  
 29.5 cm/11 5/8"

PC 11-2653-28  
 28.5 cm/11 1/4"

- EN —● Dissecting and Ligature Forceps
- DE —● Präparierklemmen
- ES —● Pinzas para preparación y ligadura

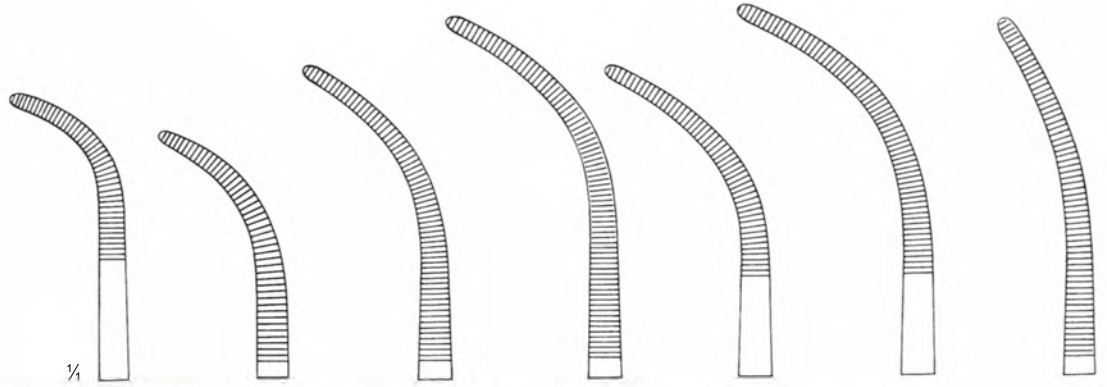

Fig. 1 PC 11-2654-20 20.5 cm/8 1/8"	Fig. 2 PC 11-2655-20 20 cm/7 7/8"	Fig. 3 PC 11-2655-21 21.5 cm/8 1/2"	Fig. 4 PC 11-2655-22 22 cm/8 1/2"	Fig. 5 PC 11-2656-21 21.5 cm/8 1/2"	Fig. 6 PC 11-2656-22 22 cm/8 1/2"	Fig. 7 PC 11-2657-22 22 cm/8 1/2"
---	---	---	---	---	---	---

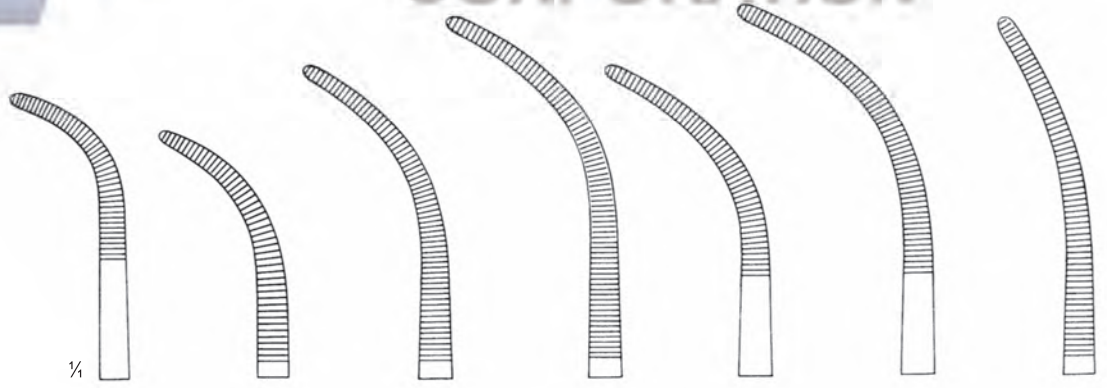
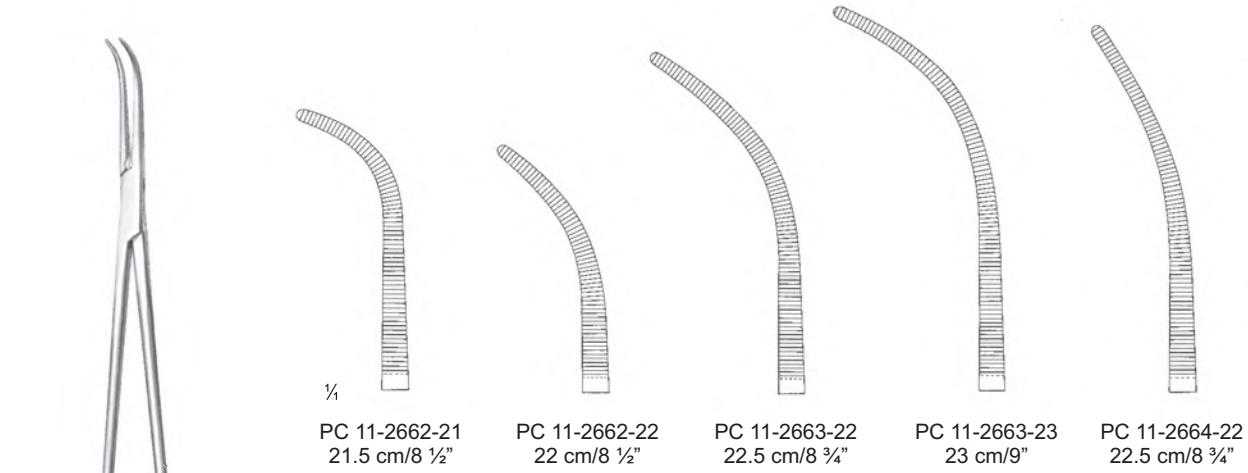

Fig. 1 PC 11-2658-27 27 cm/10 1/2"	Fig. 2 PC 11-2658-26 26.5 cm/10 3/8"	Fig. 3 PC 11-2659-27 27.5 cm/10 3/4"	Fig. 4 PC 11-2659-28 28 cm/11"	Fig. 5 PC 11-2660-27 27.5 cm/10 3/4"	Fig. 6 PC 11-2660-28 28 cm/11"	Fig. 7 PC 11-2661-28 27.5 cm/10 3/4"
--	--	--	--------------------------------------	--	--------------------------------------	--



OVERHOLT-GEISSENDORFER

Dissecting and Ligature Forceps ●— EN  
 Präparierklemmen ●— DE  
 Pinzas para preparación y ligadura ●— ES



OVERHOLT-FINO

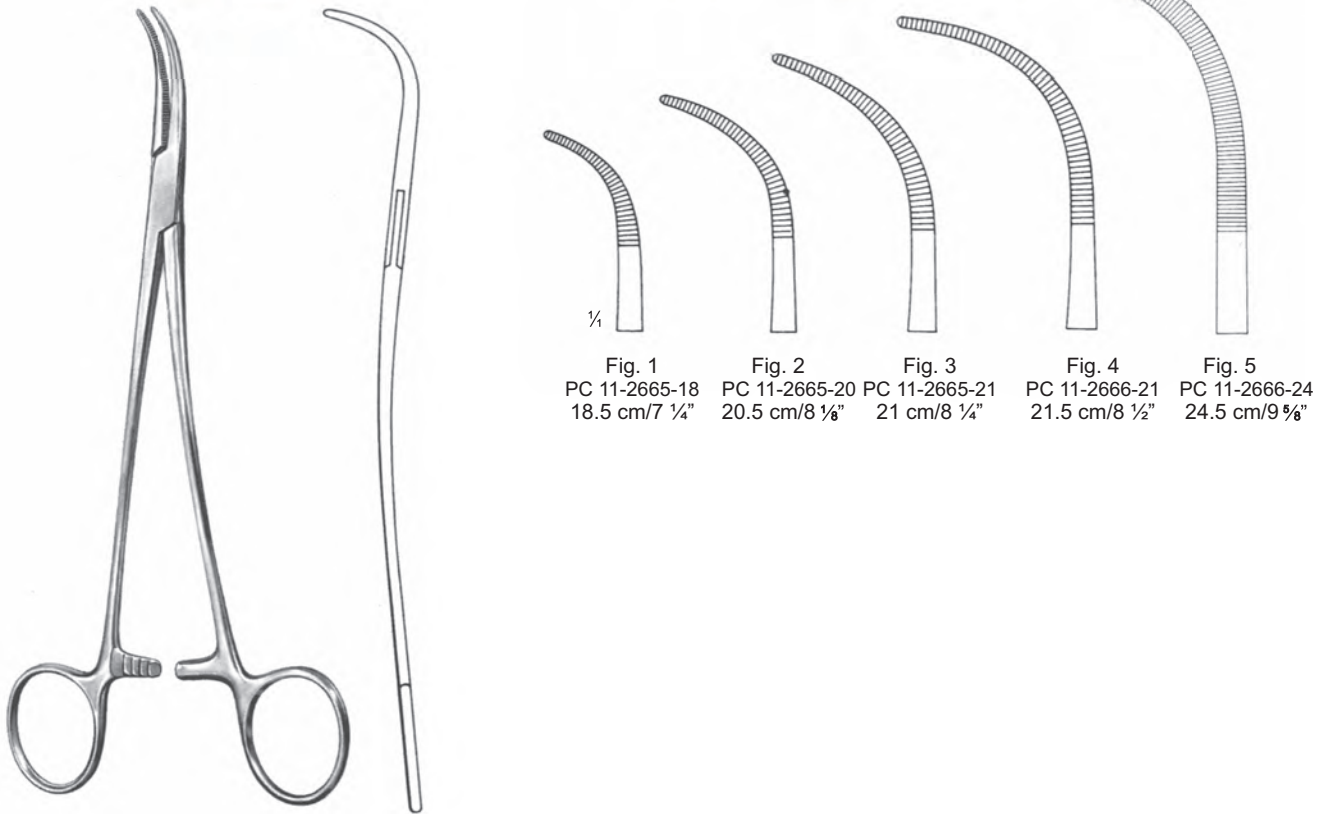

OVERHOLT-SLIM



# ARTERY FORCEPS

- EN —● Dissecting and Ligature Forceps
- DE —● Präparierklemmen
- ES —● Pinzas para preparación y ligadura

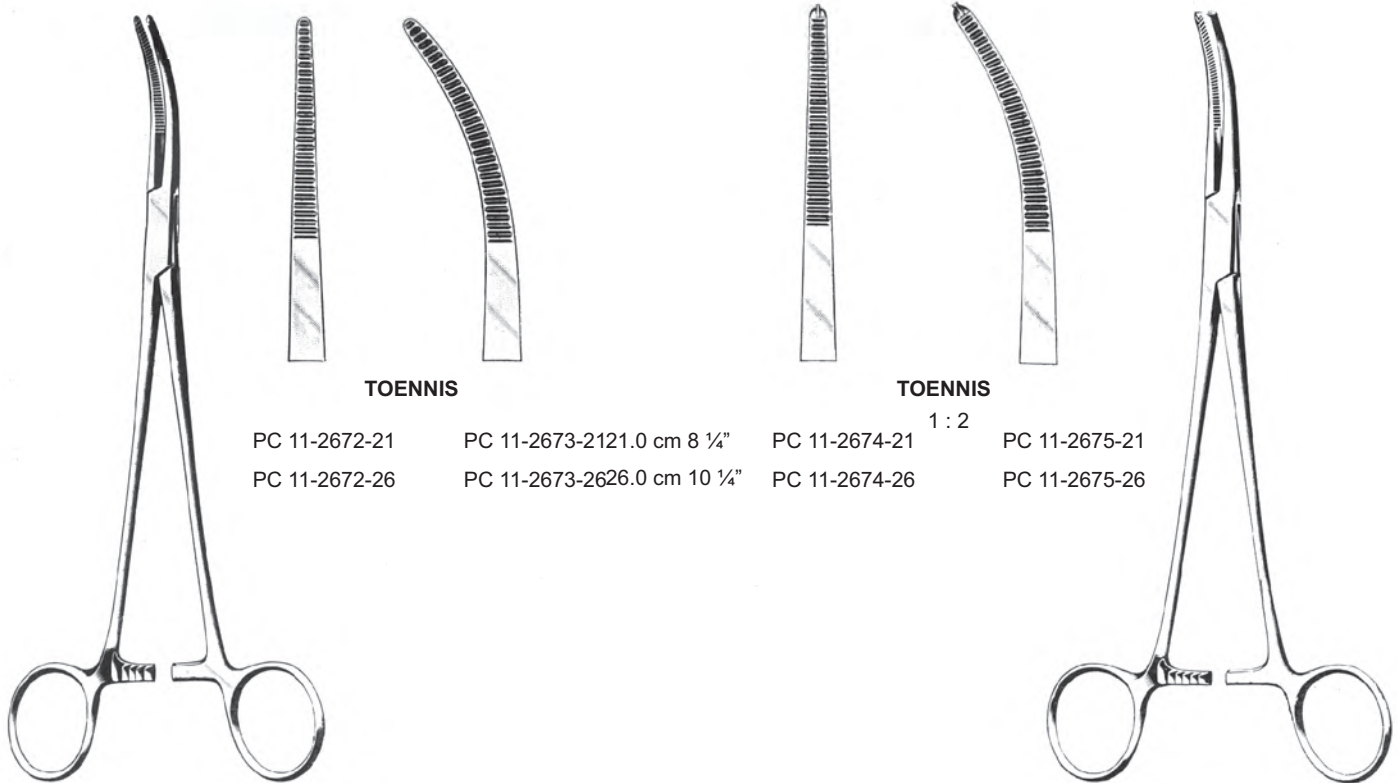
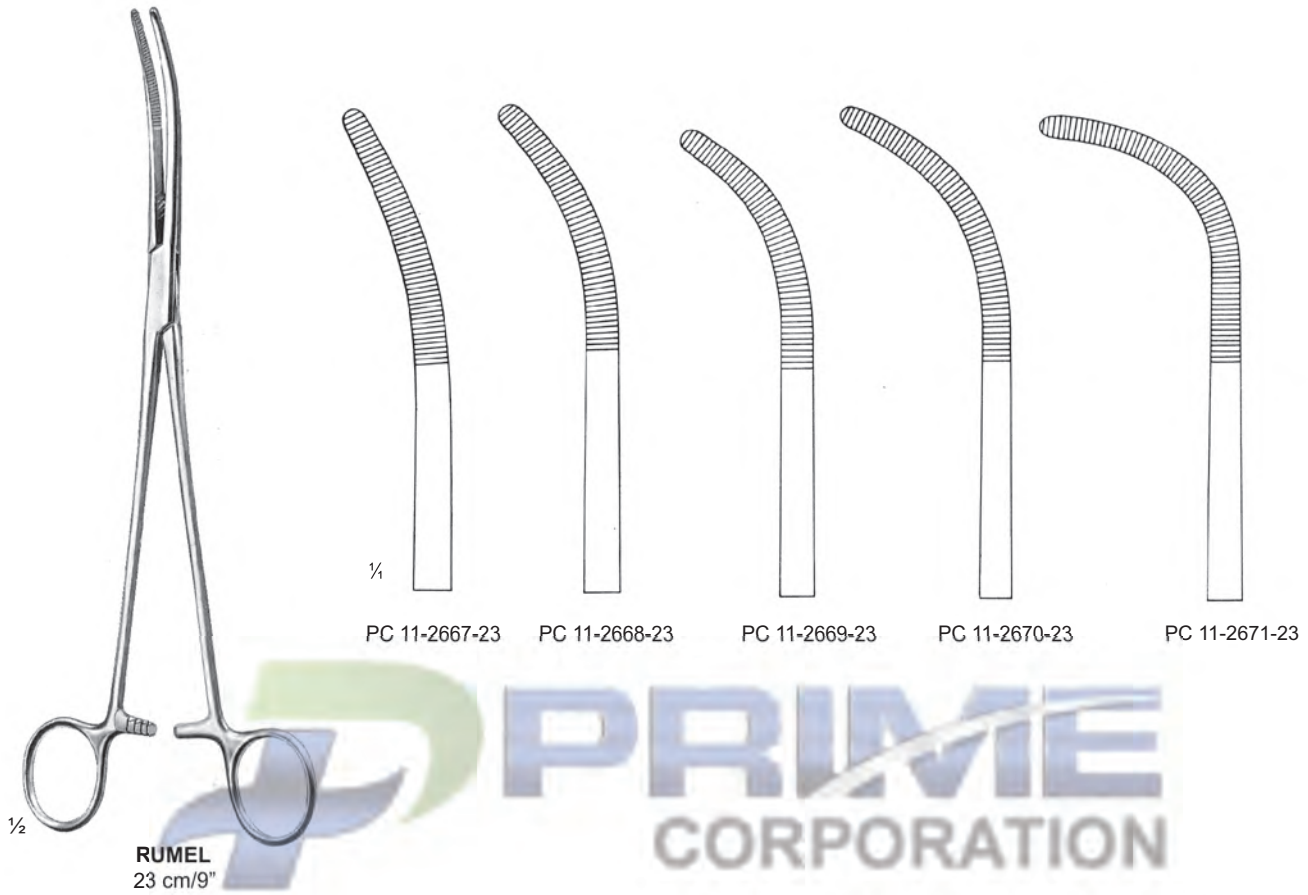

Kidney Pedicle Clamps ●— EN  
 Nierenstielklemmen ●— DE  
 Pinzas para pedículo renal ●— ES

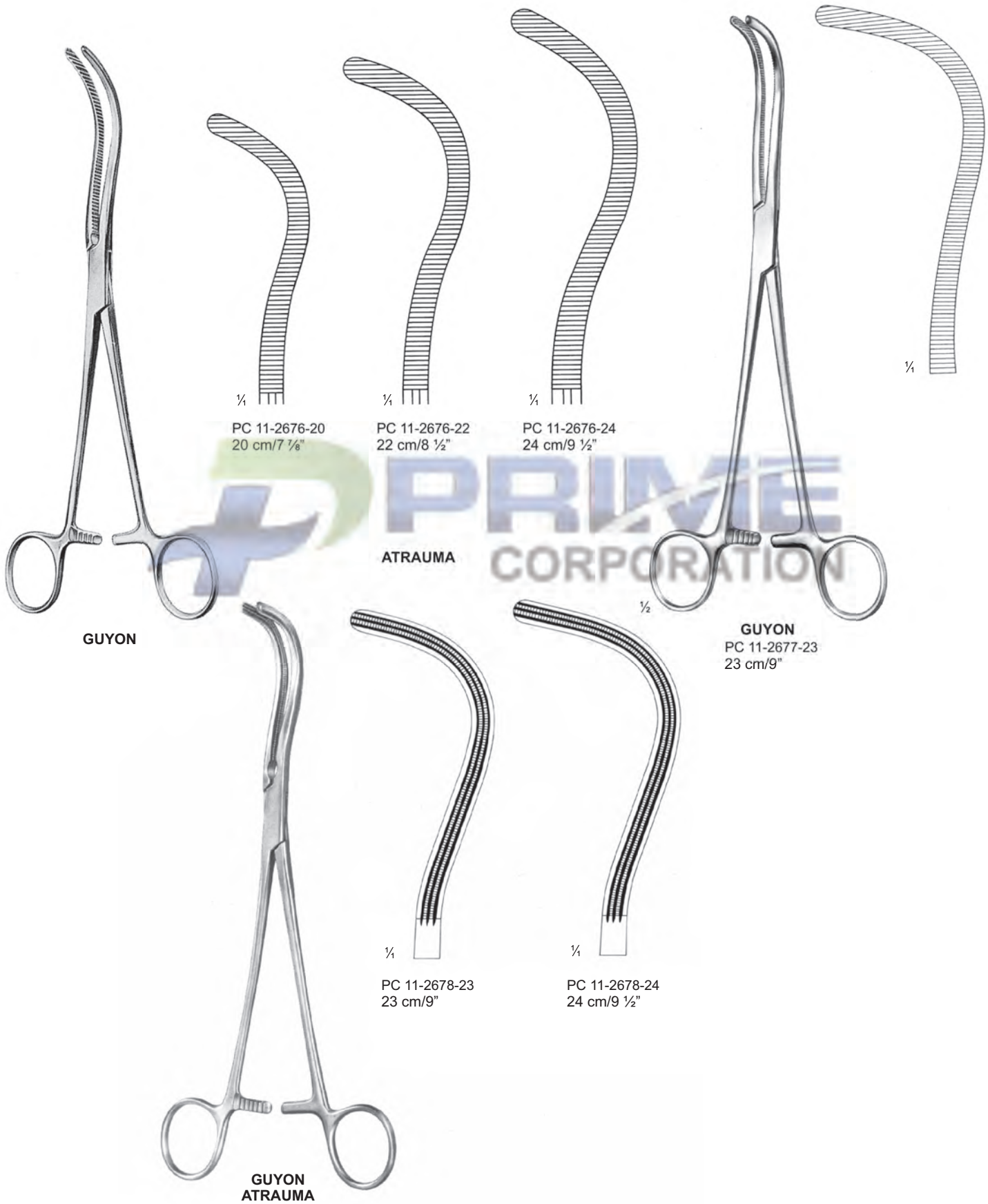

- EN —● Hysterectomy Forceps, Kidney Pedicle Clamps
- DE —● Hysterektomieklemmen, Nierenstielklemmen
- ES —● Pinzas para histerectomia, Pinzas para pediculo renal

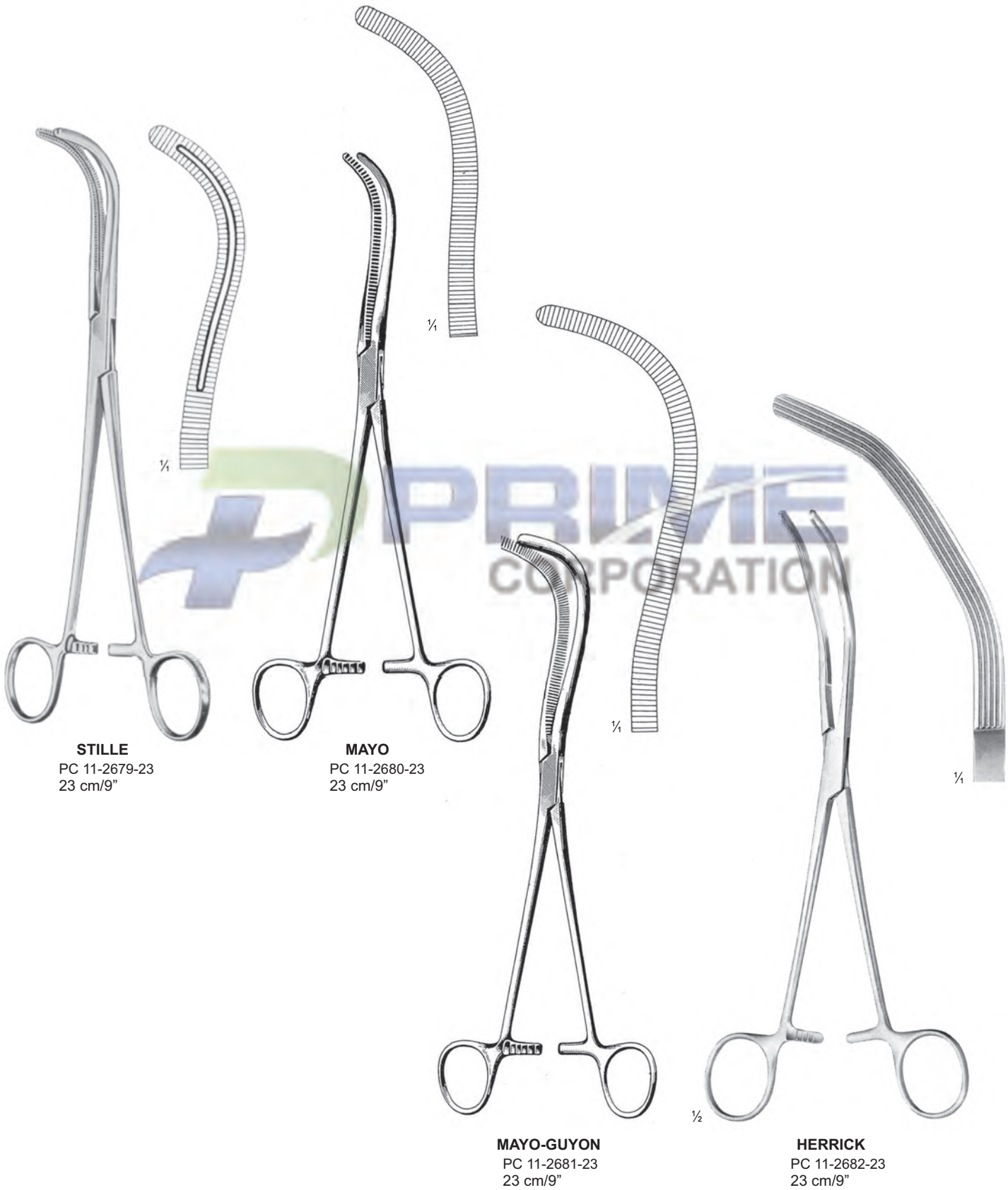

**STILLE**  
PC 11-2679-23  
23 cm/9"

**MAYO**  
PC 11-2680-23  
23 cm/9"

**MAYO-GUYON**  
PC 11-2681-23  
23 cm/9"

**HERRICK**  
PC 11-2682-23  
23 cm/9"

Hysterectomy Forceps, Kidney Pedicle Clamps ●— EN  
 Hysterektomieklemmen, Nierenstielklemmen ●— DE  
 Pinzas para histerectomia, Pinzas para pedículo renal ●— ES





**ARTERY FORCEPS**

- EN —● Gall Duct Clamps
- DE —● Gallenkanalklemmen
- ES —● Pinzas para conducto biliar

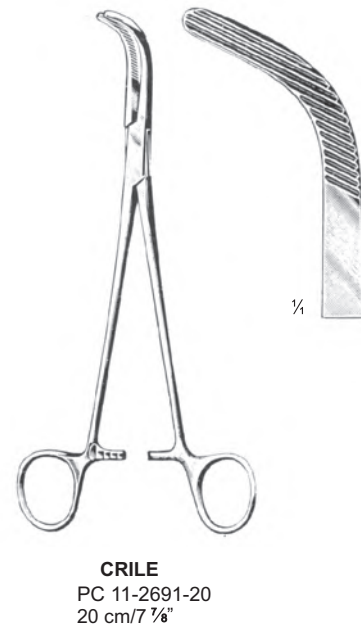
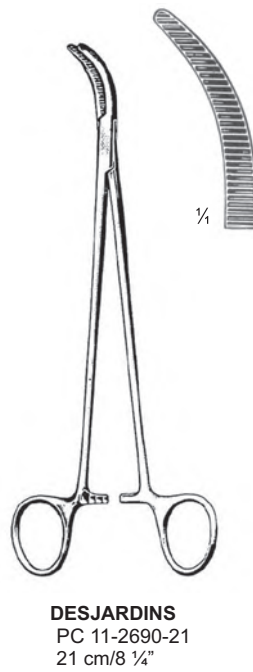
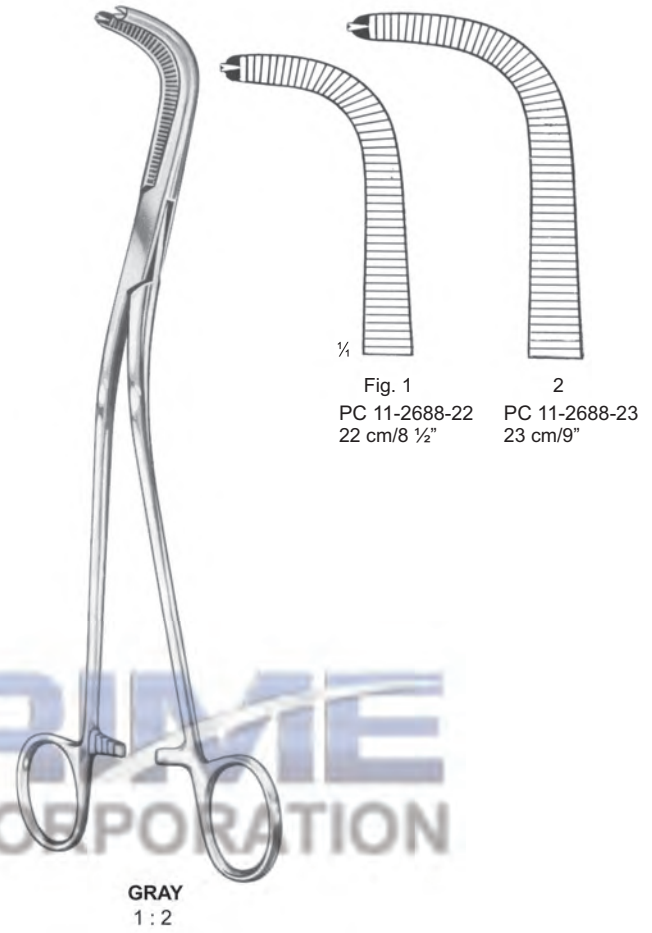
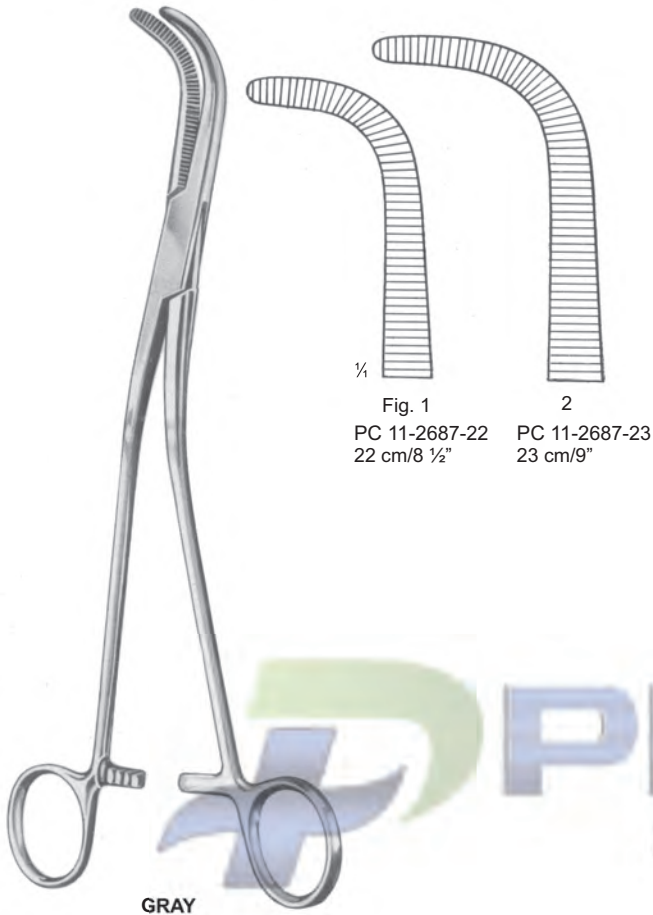

Artery Forceps, Gall Duct Forceps ●— EN  
 Arterienklemmen, Gallenkanalklemmen ●— DE  
 Pinzas hemostaticas, Pinzas para conducto biliar ●— ES

without teeth PC 11-2692-21  
 with 1 : 2 teeth PC 11-2693-21



**HOSEMANN**  
21 cm/8 1/4"

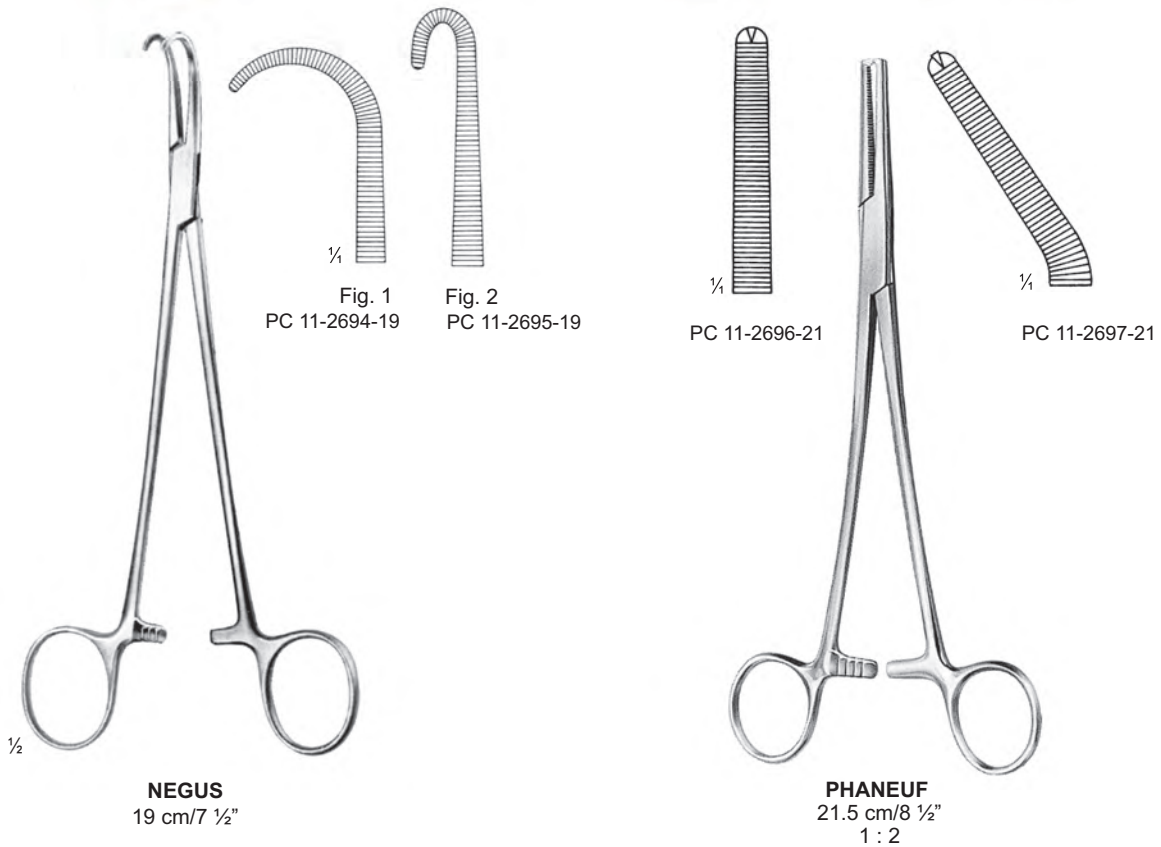

Fig. 1  
PC 11-2694-19

Fig. 2  
PC 11-2695-19

PC 11-2696-21

PC 11-2697-21

**NEGUS**  
19 cm/7 1/2"

**PHANEUF**  
21.5 cm/8 1/2"  
1 : 2

- EN —● Clamp Forceps, Hysterectomy and Vaginal Forceps
- DE —● Klemmzangen, Hysterektomieklemmen, Baginalklemmen
- ES —● Pinzas-clamps, pinzas-clamps para histerecctoa y vaginales



1 Tooth	<b>HEANEY</b>	2 Teeth
PC 11-2698-19	19.5 cm/7 1/2"	PC 11-2699-19
PC 11-2698-21	21.0 cm/8 1/4"	PC 11-2699-21
PC 11-2698-23	23.0 cm/9"	PC 11-2699-23

**WERTHEIM-CULLEN**  
 PC 11-2700-21  
 21.5 cm/8 1/2"

**WERTHEIM**  
 PC 11-2701-24  
 24 cm/9 1/2"  
 Extra Strong

- Hysterectomy Forceps ●— EN
- Hysterektomieklemmen ●— DE
- Pinzas para histerectomia ●— ES

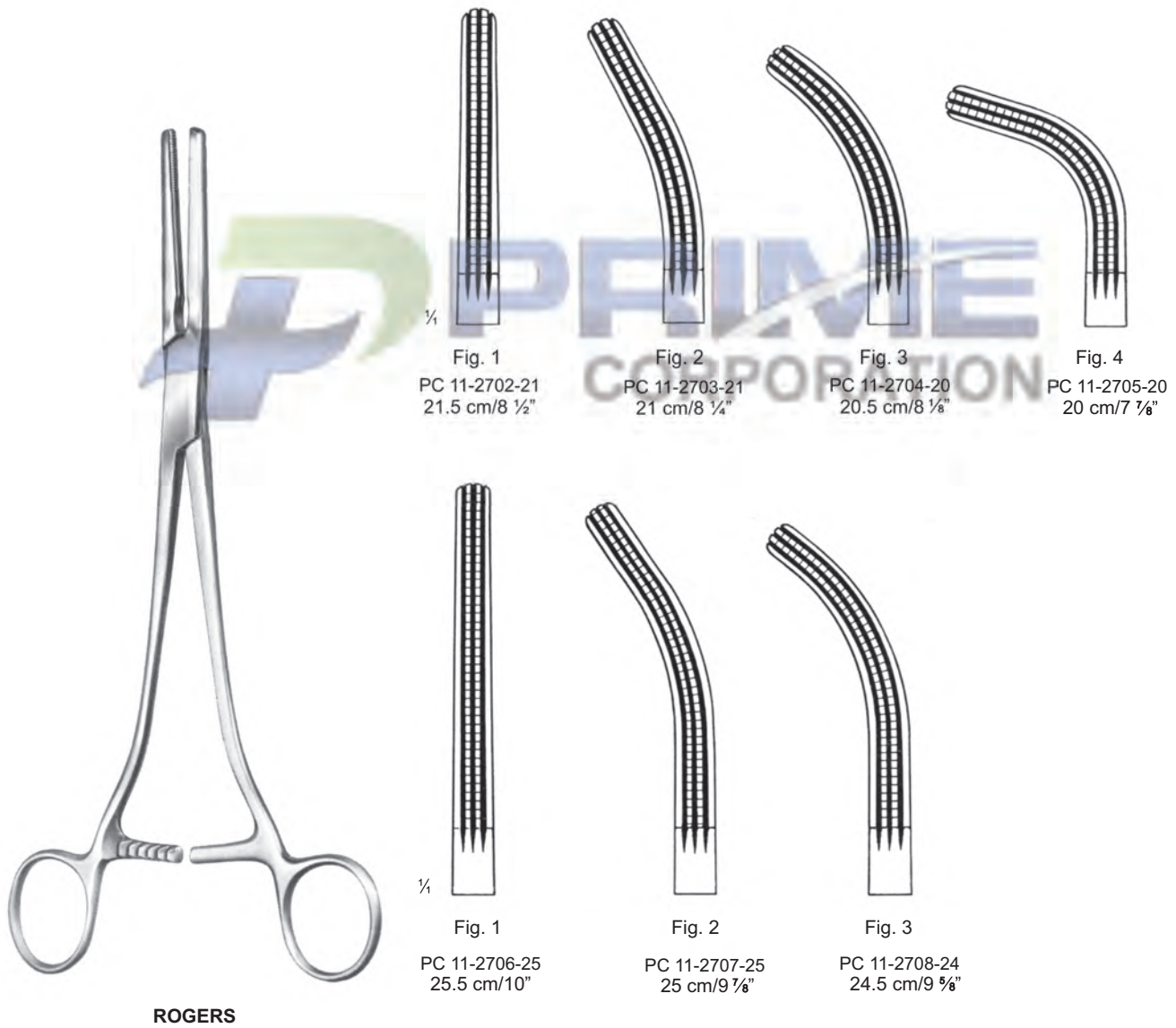



**ARTERY FORCEPS**

- EN —● Clamp Forceps, Hysterectomy and Vaginal Forceps
- DE —● Klemmzangen, Hysterektomieklemmen, Baginalklemmen
- ES —● Pinzas-clamps, pinzas-clamps para histerecctoa y vaginales

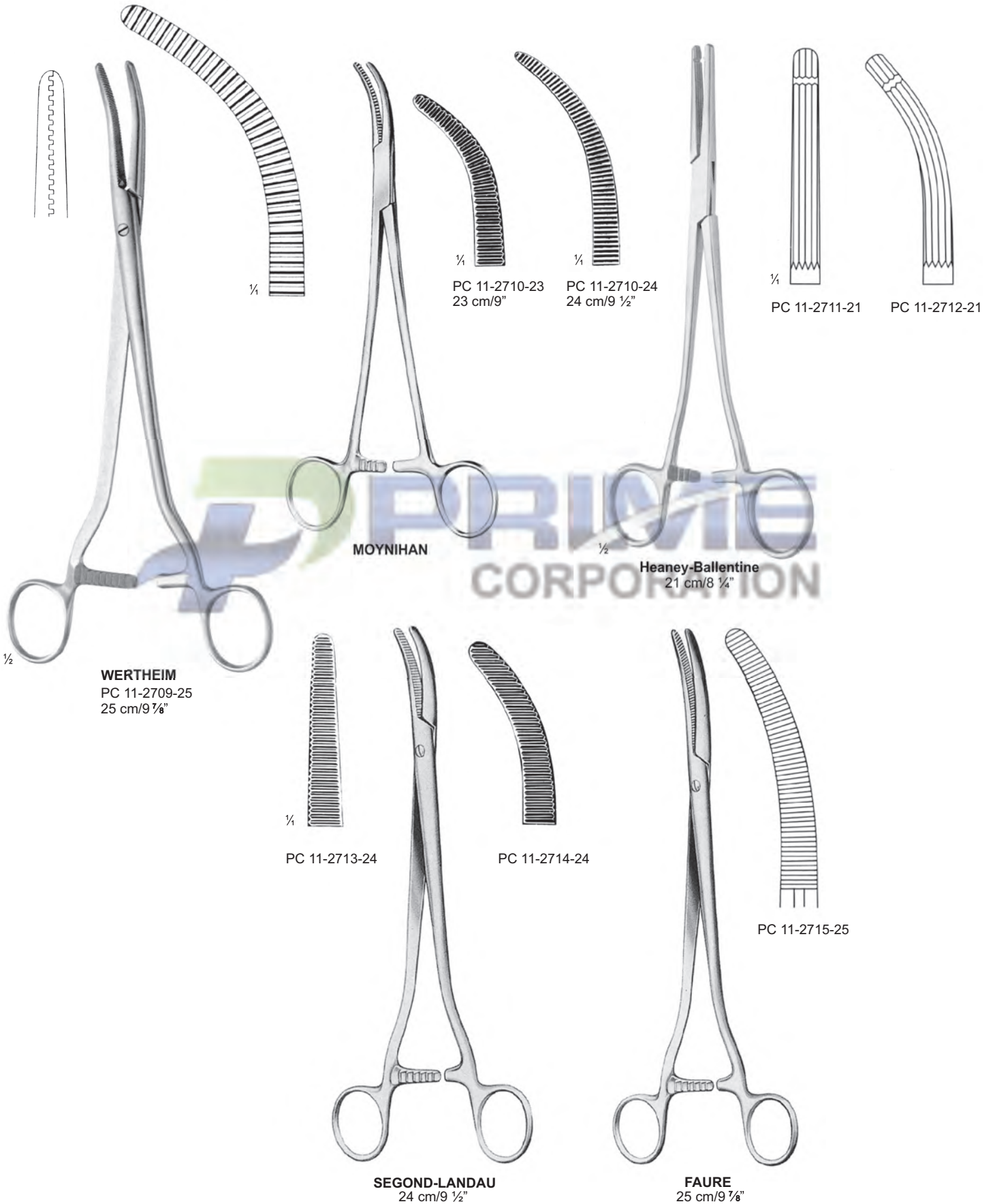

Clamp Forceps, Hysterectomy and Vaginal Forceps ●— EN  
 Klemmzangen, Hysterektomieklemmen, Baginalklemmen ●— DE  
 Pinzas-clamps, pinzas-clamps para histerecctioia y vaginales ●— ES

Heavy pattern



**WERTHEIM**  
23 cm/9"

**WERTHEIM**  
PC 11-2719-18  
18 cm/7 1/8"

**WERTHEIM**  
PC 11-2720-25  
25 cm/9 7/8"

- EN —● Clamp Forceps, Hysterectomy and Vaginal Forceps
- DE —● Klemmzangen, Hysterektomieklemmen, Baginalklemmen
- ES —● Pinzas-clamps, pinzas-clamps para histerecctoa y vaginales



**WERTHEIM**  
PC 11-2721-25  
25 cm/9 7/8"

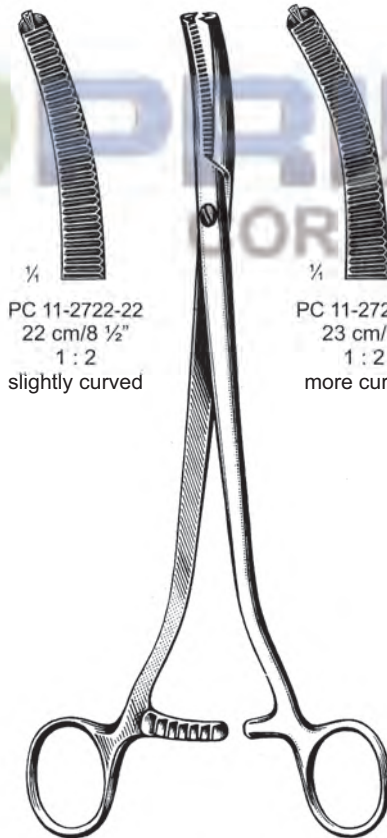

PC 11-2722-22  
22 cm/8 1/2"  
1 : 2  
slightly curved



PC 11-2722-23  
23 cm/9"  
1 : 2  
more curved

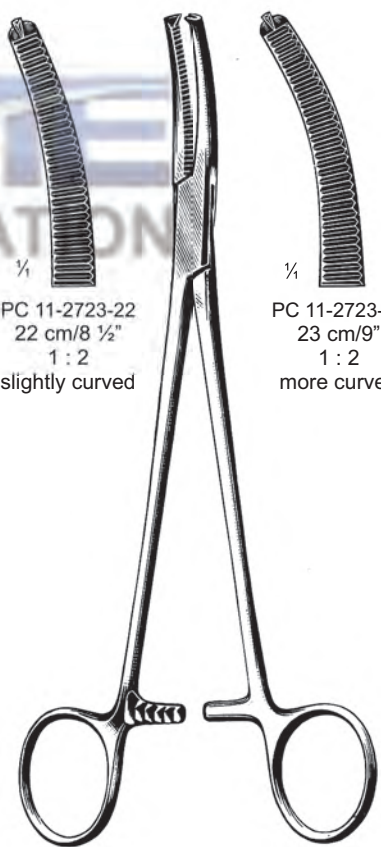

PC 11-2723-22  
22 cm/8 1/2"  
1 : 2  
slightly curved



PC 11-2723-23  
23 cm/9"  
1 : 2  
more curved

Hysterectomy Forceps ●— EN  
 Peritoneumklemmen ●— DE  
 Pinzas-clamps para peritoneo ●— ES

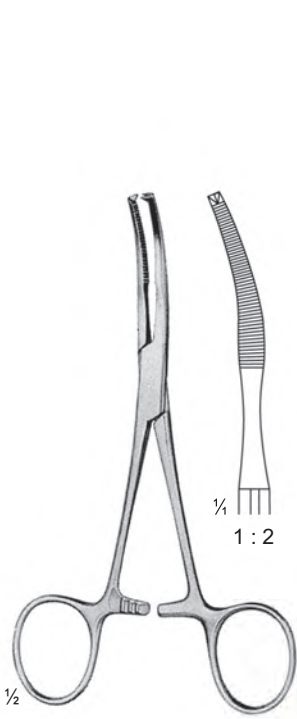

**BABY-MIKULICZ**  
 PC 11-2724-14  
 14 cm/5 1/2"

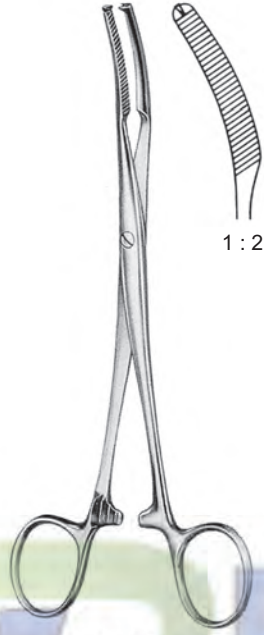

**MIKULICZ**  
 PC 11-2725-18 18 cm/7 1/8"  
 PC 11-2725-20 20 cm/7 7/8"

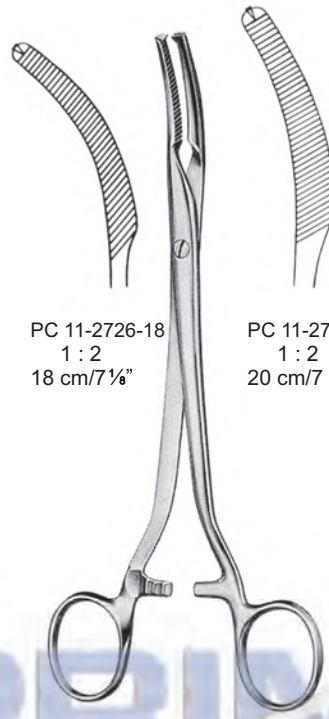

PC 11-2726-18  
 1 : 2  
 18 cm/7 1/8"

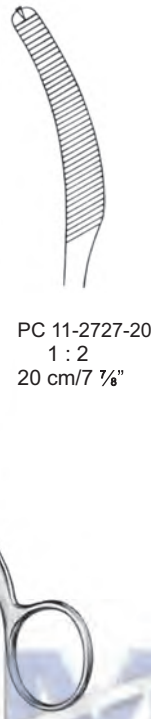

PC 11-2727-20  
 1 : 2  
 20 cm/7 7/8"

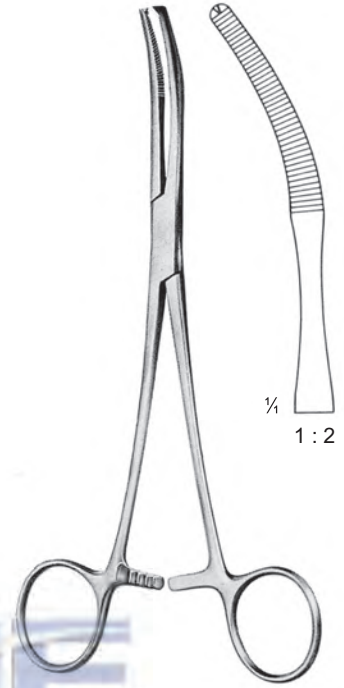

**MIKULICZ**  
 PC 11-2728-20 20 cm/7 7/8"

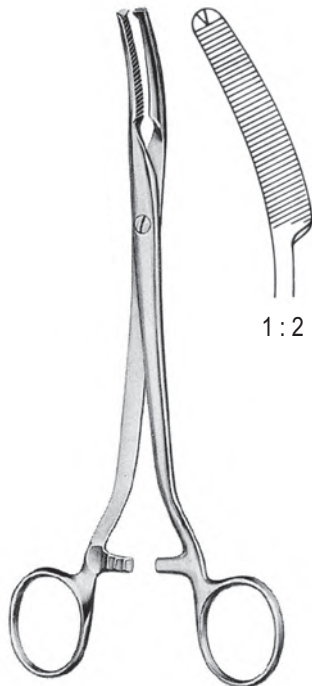

**MIKULICZ**  
 PC 11-2729-20  
 20.5 cm/8 1/8"

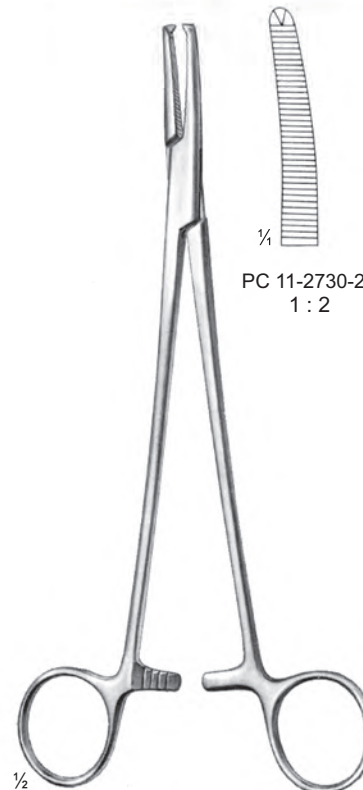

**FAURE**  
 20 cm/7 7/8"

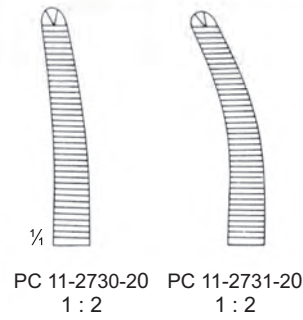

PC 11-2730-20  
 1 : 2

PC 11-2731-20  
 1 : 2





Towel Clamps ●— EN  
 Tuchklemmen ●— DE  
 Pinzas de campo ●— ES



**SCHAEDEL**  
 PC 11-2738-09  
 9 cm/3 1/2"

**ENGL. MODELL**  
 PC 11-2739-09  
 9 cm/3 1/2"

**JONES**  
 PC 11-2740-05 5 cm/2"  
 PC 11-2740-09 9 cm/3 1/2"

**JONES**  
 PC 11-2741-09  
 9 cm/3 1/2"

**DOYEN**  
 PC 11-2742-11  
 11 cm/4 3/8"

**DOYEN**  
 PC 11-2743-18  
 18 cm/7 1/8"

With Clip for Tubing or Cable



**BACKHAUS**  
 PC 11-2744-11 11 cm/4 3/8"  
 PC 11-2744-13 13 cm/5 1/8"  
 Delicate pattern, sharp



**BACKHAUS**  
 PC 11-2745-11  
 11 cm/4 3/8"  
 With Clip for Tubing or Cable

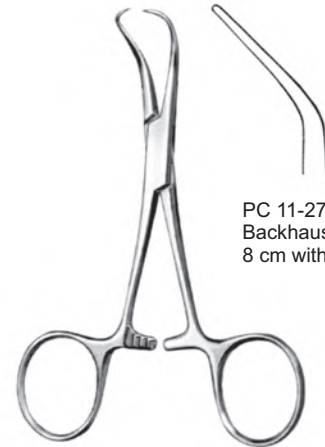

**BACKHAUS**  
 PC 11-2746-08 8 cm/3 1/4"  
 PC 11-2746-08 11 cm/4 3/8"  
 PC 11-2746-08 13 cm/5 1/8"  
 PC 11-2746-08 15 cm/5 7/8"  
 PC 11-2747-08  
 Backhaus Towel  
 8 cm with open jaws

- EN —● Towel Clamps
- DE —● Tuchklemmen
- ES —● Pinzas de campo

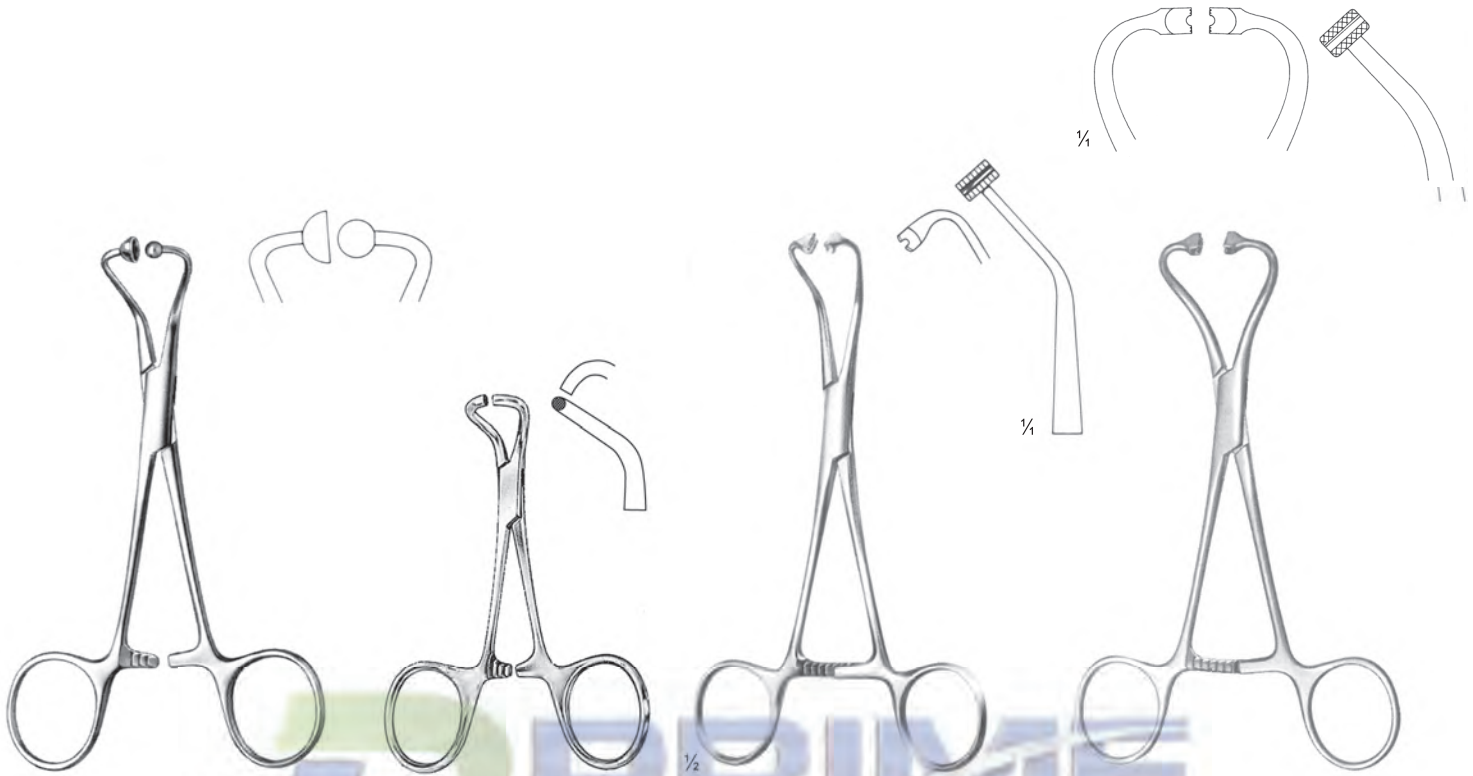

**BALL & SOCKET**

PC 11-2748-11 11.5 cm/4 1/2"

PC 11-2748-14 14 cm/5 1/2"

**TOHOKU**

PC 11-2749-10 10.5 cm/4 1/8"

PC 11-2749-13 13.5 cm/5 3/8"

**PEERS BERTRAM**

PC 11-2750-14 14.5 cm/5 3/4"

**PEERS-BERTRAM MODIF.**

PC 11-2751-15 15.5 cm/6 1/8"



**HOFF**

PC 11-2752-11 11 cm/4 3/8"  
PC 11-2752-14 14.5 cm/5 3/4"

**ROBIN**

PC 11-2753-13 13.5 cm/5 3/8"  
with holder for cable up to 5 mm

**ROBIN**

PC 11-2754-13 13.5 cm/5 3/8"  
with holder for cable up to 13 mm tubing

**PAPER TOWEL FORCEPS**

PC 11-2755-10 10 cm/3 1/8"  
PC 11-2755-13 13 cm/5 1/8"

Towel Forceps, Tubing Clamps ●— EN  
 Tuchklemmen, Schlauchklemmen ●— DE  
 Pinzas de campo, Pinzas para tubos ●— ES



**ROEDER**  
 PC 11-2756-13 13 cm/5 1/8"  
 PC 11-2756-15 15 cm/5 7/8"

**LORNA**  
 PC 11-2757-10 10 cm/3 7/8"  
 PC 11-2757-13 13 cm/5 1/8"

**BERNHARD**  
 PC 11-2758-16  
 16.5 cm/6 1/2"

**LANE**  
 PC 11-2759-20  
 20 cm/7 7/8"



PC 11-2760-14  
 14.5 cm/5 3/4"  
 with extra long ratchet

**SCHOENBERG**  
 PC 11-2761-15 15.5 cm/6 1/8"  
 PC 11-2761-19 19 cm/7 1/2"  
 PC 11-2761-20 20 cm/7 7/8"

**SCHOENBERG**  
 PC 11-2762-15 15.5 cm/6 1/8"  
 PC 11-2762-19 19 cm/7 1/2"  
 PC 11-2762-20 20 cm/7 7/8"  
 with safety guard

**PRESBYTERIAN-HOSPITAL**  
 PC 11-2763-15 15.5 cm/6 1/8"  
 PC 11-2763-19 19 cm/7 1/2"  
 PC 11-2763-20 20 cm/7 7/8"



- EN —● Sinus Forceps, Dressing Forceps
- DE —● Sinusklemmen, Kornzangen
- ES —● Pinzas para vendajes, Pinzas para vendajes



**LISTER**  
PC 11-2764-20  
20 cm/7 7/8"

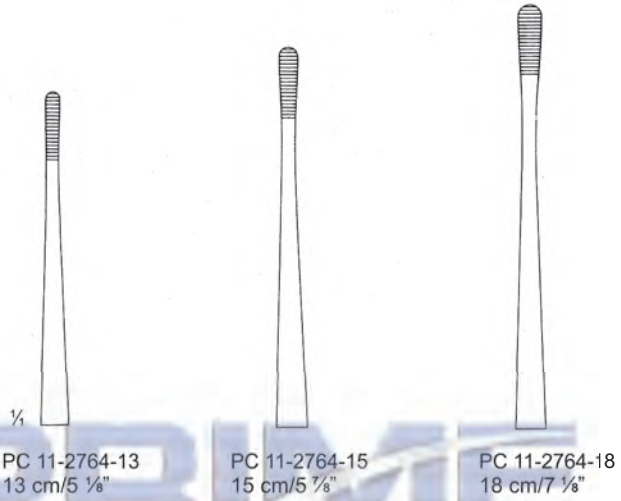

1/4  
PC 11-2764-13  
13 cm/5 1/8"

PC 11-2764-15  
15 cm/5 7/8"

PC 11-2764-18  
18 cm/7 1/8"

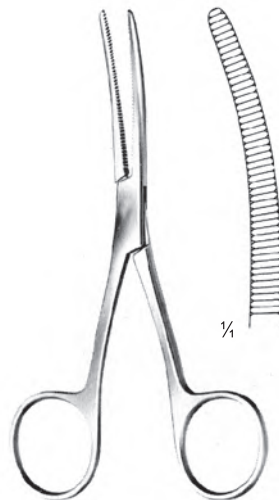

**BRYANT**  
PC 11-2765-13  
13 cm/5 1/8"

- EN** Cotton Swab Forceps
- DE** Tupfer-und Kornzangen
- ES** Pinzas para tapones y curaciones

Page 158 to 163

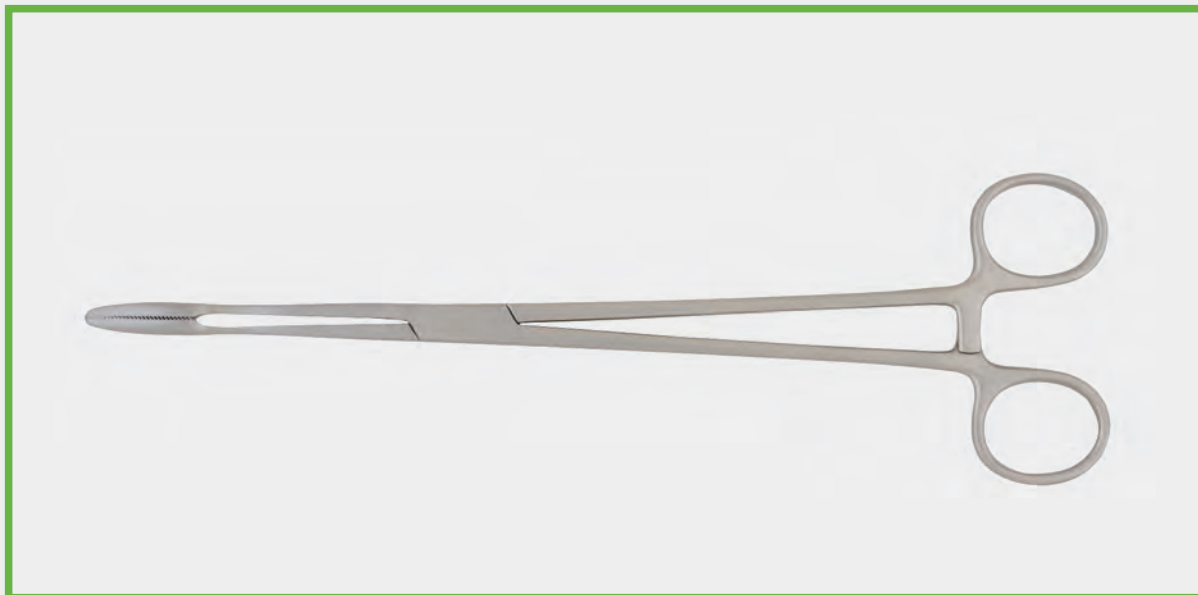

- EN —● Dressing and Cotton Swab Forceps
- DE —● Komzangen und Tupferzangen
- ES —● Pinzas para vendajes y tapones



**GROSS-MAIER**

**GROSS-MAIER**

**GROSS-MAIER**

straight	curved	cm	in	straight	curved	straight	curved	
		14.5	5 3/4"	PC 12-2803-14	PC 12-2804-14	PC 12-2805-20	20 cm/7 7/8"	PC 12-2806-20
PC 12-2801-16	PC 12-2802-16	16	6 1/4"	PC 12-2803-16	PC 12-2804-16	PC 12-2805-22	22 cm/8 1/2"	PC 12-2806-22
PC 12-2801-18	PC 12-2802-18	18	7 1/8"	PC 12-2803-18	PC 12-2804-18	PC 12-2805-25	25 cm/9 7/8"	PC 12-2806-25
PC 12-2801-20	PC 12-2802-20	20	7 7/8"	PC 12-2803-20	PC 12-2804-20			
PC 12-2801-25	PC 12-2802-25	25	9 7/8"	PC 12-2803-25	PC 12-2804-25			

Dressing and Cotton Swab Forceps ● EN  
 Komzangen und Tupferzangen ● DE  
 Pinzas para vendajes y tapones ● ES

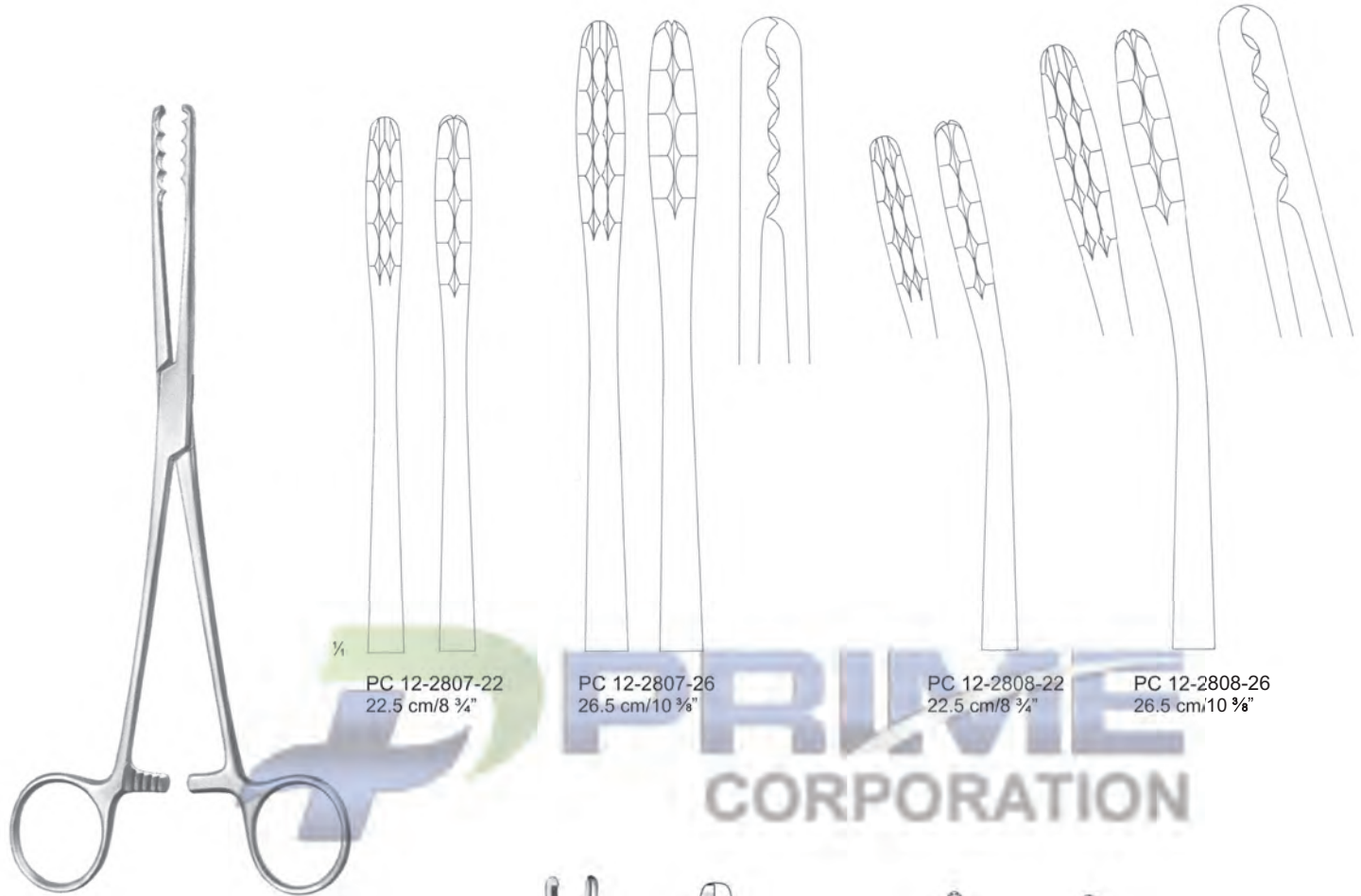

**ULRICH**

PC 12-2807-22 22.5 cm/8 ¾"  
 PC 12-2807-26 26.5 cm/10 ⅜"  
 PC 12-2808-22 22.5 cm/8 ¾"  
 PC 12-2808-26 26.5 cm/10 ⅜"



**EMMET**  
 PC 12-2809-21  
 21 cm/8 ¼"

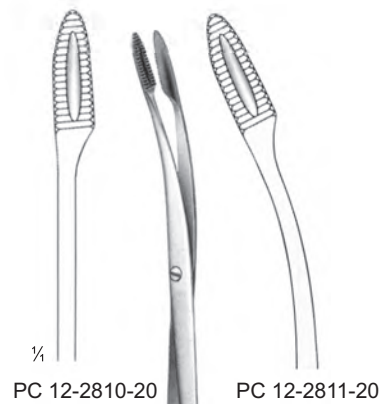

**DUPLAY**  
 20 cm/7 ⅞"



- EN —● Dressing and Cotton Swab Forceps
- DE —● Komzangen und Tupferzangen
- ES —● Pinzas para vendajes y tapones

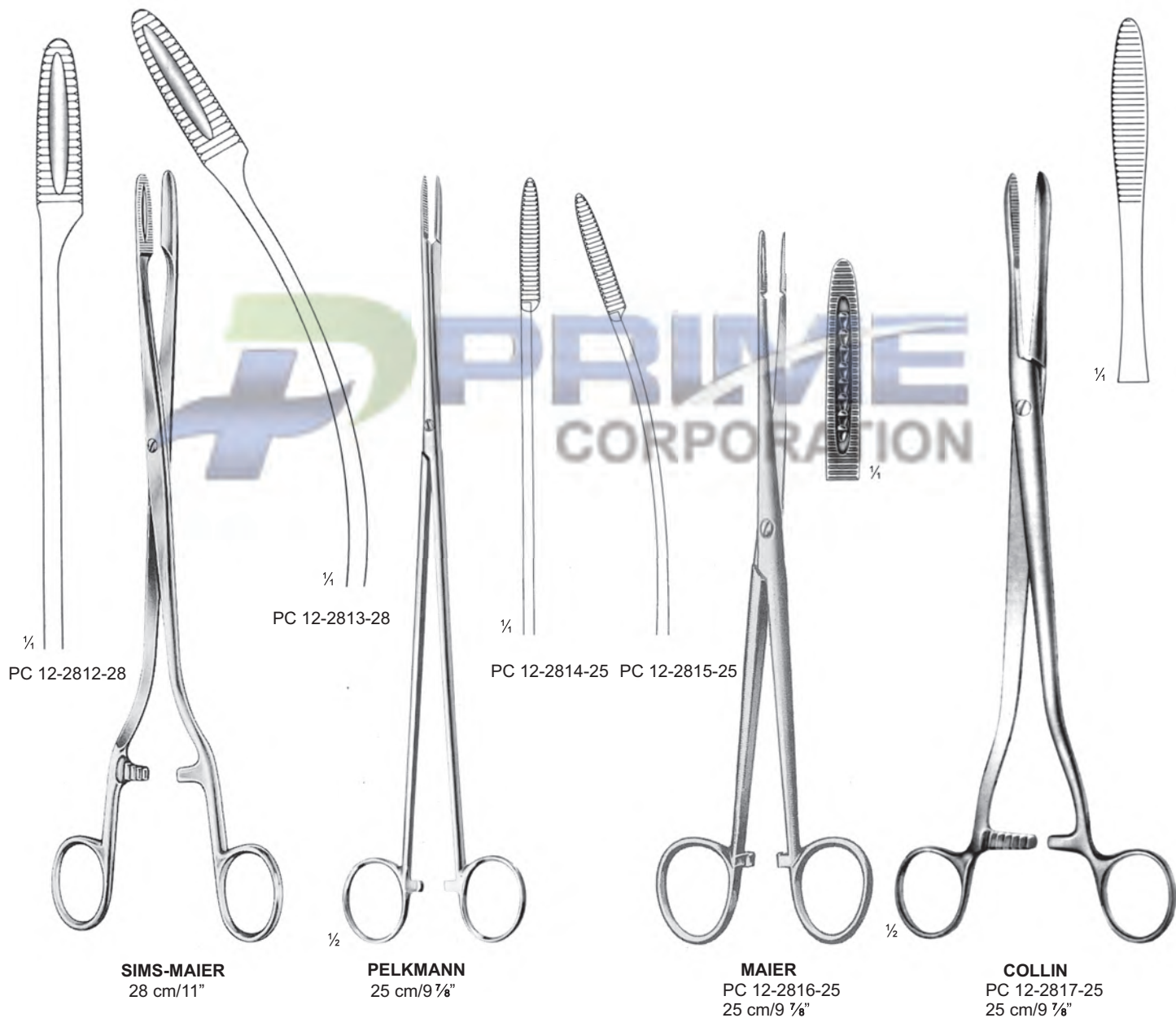

Dressing and Cotton Swab Forceps ● EN  
 Komzangen und Tupferzangen ● DE  
 Pinzas para vendajes y tapones ● ES



**CHERON**  
 PC 12-2818-25  
 25 cm/9 7/8"

**BOZEMANN**  
 PC 12-2819-26  
 26 cm/10 1/4"  
 S-shaped

**BOZEMANN**  
 PC 12-2820-26  
 26 cm/10 1/4"

**BOZEMANN DOUGLAS**  
 PC 12-2821-26  
 26 cm/10 1/4"

- EN —● Dressing and Cotton Swab Forceps
- DE —● Komzangen und Tupferzangen
- ES —● Pinzas para vendajes y tapones



↑ **FOERSTER**

18 cm/7 1/8" PC 12-2822-18  
 20 cm/7 7/8" PC 12-2822-20  
 25 cm/9 7/8" PC 12-2822-25

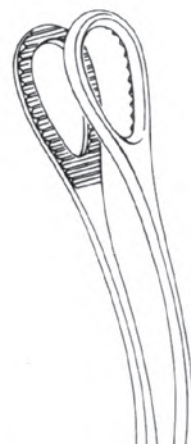
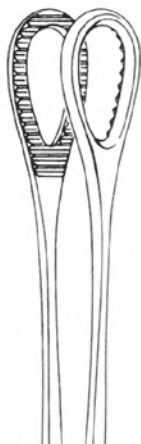

PC 12-2823-18  
 PC 12-2823-20  
 PC 12-2823-25

PC 12-2824-18  
 PC 12-2824-20  
 PC 12-2824-25

PC 12-2825-18  
 PC 12-2825-20  
 PC 12-2825-25

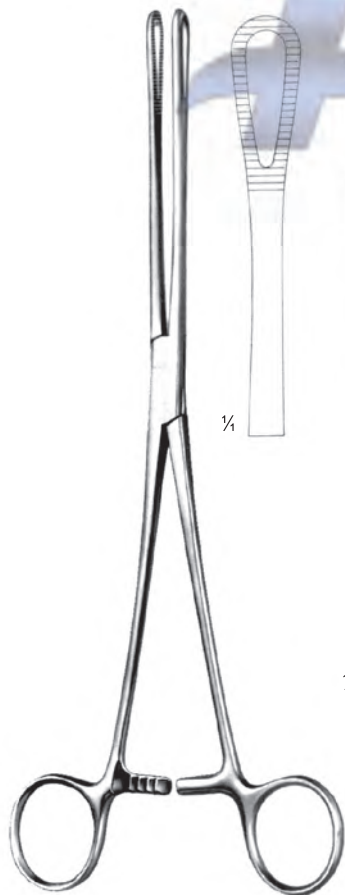

**RAMPLEY**  
 PC 12-2826-18 18.5 cm/7 1/4"  
 PC 12-2826-24 24.5 cm/9 5/8"

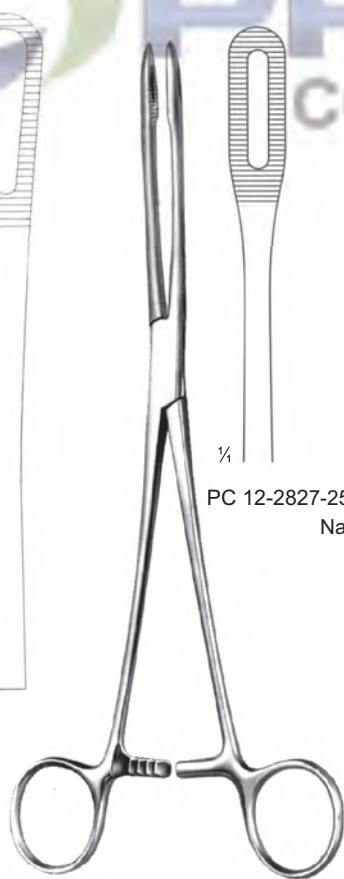

**FOERSTER**  
 25 cm/9 7/8"

PC 12-2827-25 PC 12-2828-25  
 Narrow

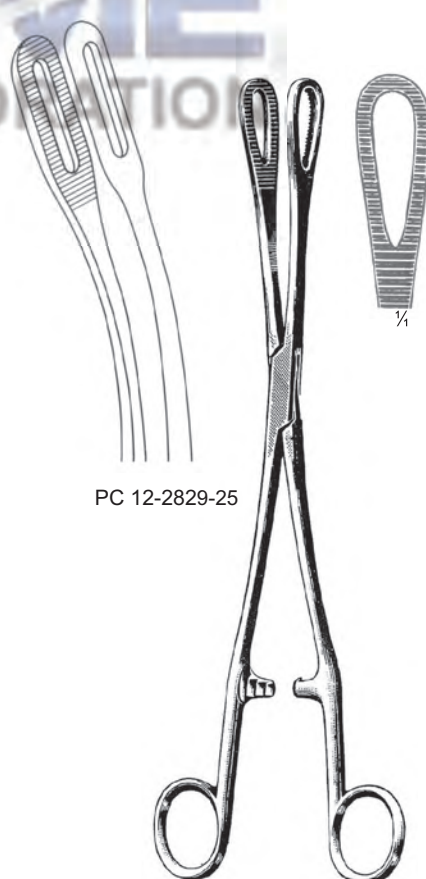

**RAMPLEY**  
 PC 12-2830-25  
 25 cm/9 7/8"

Dressing and Cotton Swab Forceps ● EN  
 Komzangen und Tupferzangen ● DE  
 Pinzas para vendajes y tapones ● ES



**BERGMANN-FOERSTER**  
 PC 12-2831-24  
 24 cm/9 1/2"

**BERGMANN-FOERSTER**  
 PC 12-2832-24  
 24 cm/9 1/2"

**FLETCHER (JAVERTS)**  
 PC 12-2833-24  
 24 cm/9 1/2"

**FLETCHER (JAVERTS)**  
 PC 12-2834-24  
 24 cm/9 1/2"



- EN** Probes, Applicators, Spatulas
- DE** Sonden, Watteträger, Spatel
- ES** Sondas, Porta-algodones, Espátulas

Page 164 to 169



EN —● Probes  
 DE —● Knopfsonden  
 ES —● Sondas abotonadas

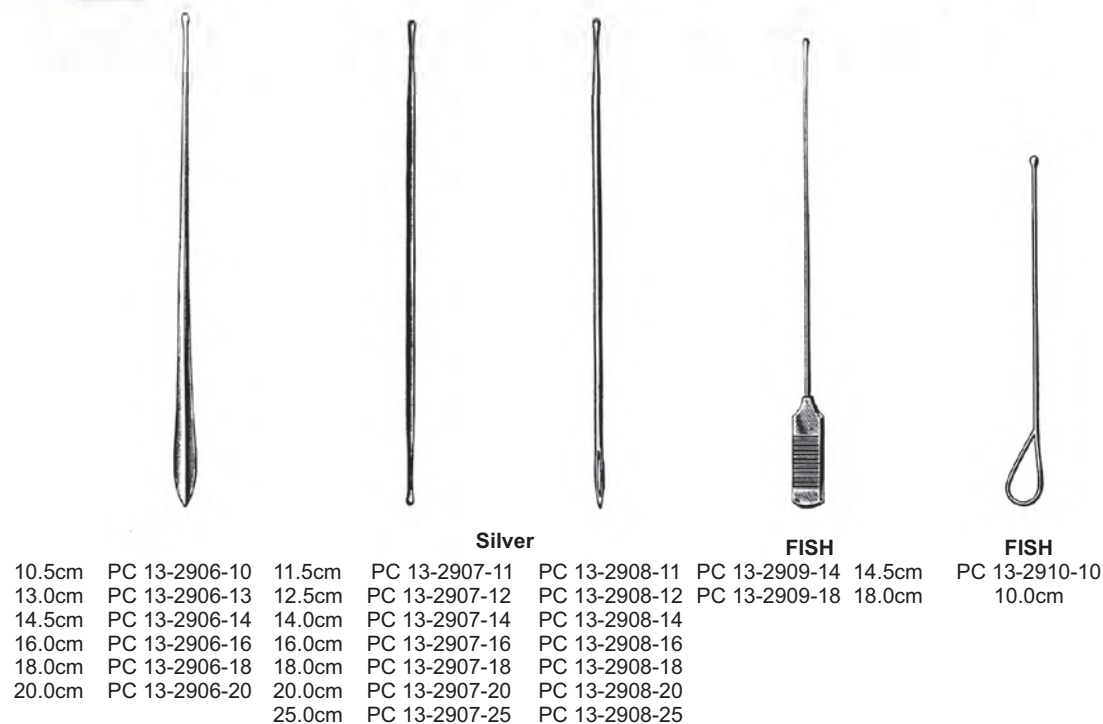
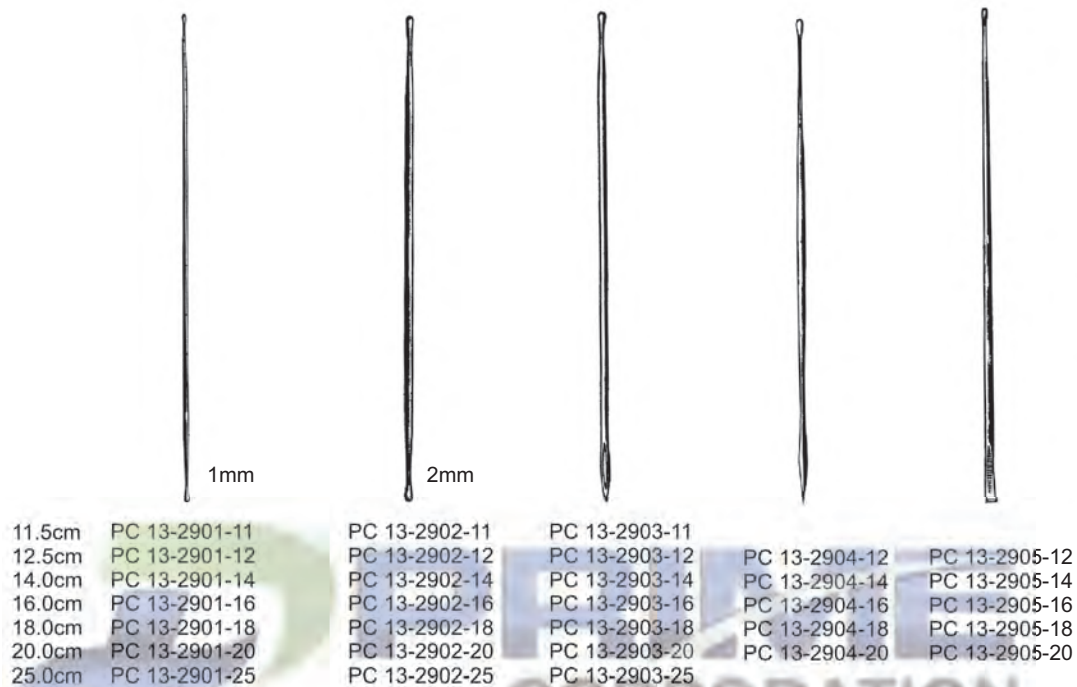

Probes, Seeker and Directors ●— EN  
 Sonden und Finder ●— DE  
 Sondas, estiletes v sondas ●— ES



11.5cm PC 13-2911-11  
 12.5cm PC 13-2911-12  
 14.0cm PC 13-2911-14  
 16.0cm PC 13-2911-16  
 18.0cm PC 13-2911-18  
 20.0cm PC 13-2911-20

PC 13-2912-11  
 PC 13-2912-12  
 PC 13-2912-14  
 PC 13-2912-16  
 PC 13-2912-18  
 PC 13-2912-20

**DOYEN**  
 PC 13-2913-14  
 14.0cm

**NELATON**  
 PC 13-2914-16  
 16.0cm

PC 13-2915-12  
 12.0cm



**KRONECKER**  
 PC 13-2916-16  
 13.0 cm

**JOHNS-HOPKINS**  
 PC 13-2917-15  
 15.0 cm

**ROSER**  
 PC 13-2918-12  
 12.5 cm

**SYME**  
 PC 13-2919-17  
 17.0 cm

PC 13-2920-17  
 17.0 cm

- EN —● Elevators and Plaster Spatula
- DE —● Elevatoren und Pflasterspatel
- ES —● Elevadores y espátulas



PC 13-2921-13 13.0 cm  
PC 13-2921-14 14.5 cm



PC 13-2922-17 17.5 cm



**MCDONALD**  
PC 13-2923-19 19.0 cm



**KILLIAN**  
PC 13-2924-19 19.0 cm



**WATSON CHEYENE**  
PC 13-2925-13 13.0 cm  
PC 13-2925-19 19.0 cm



**WATSON CHEYENE**  
PC 13-2926-17 17.5 cm



**PLAYFAIR**  
PC 13-2927-31 31.0 cm



**CHEYENE**  
PC 13-2928-12 12.5 cm  
PC 13-2928-17 17.5 cm



Cotton Applicators ●— EN  
 Watteträger ●— DE  
 Porta-algodones ●— ES



	<b>FARREL</b>	<b>FARREL</b>	<b>FARREL</b>				<b>JOBSON-HORNE</b>
12.0cm	PC 13-2929-12	PC 13-2930-12	PC 13-2931-12	PC 13-2932-12	PC 13-2933-12	PC 13-2934-12	PC 13-2935-12 12.5 cm
14.0cm	PC 13-2929-14	PC 13-2930-14	PC 13-2931-14	PC 13-2932-14	PC 13-2933-14	PC 13-2934-14	PC 13-2935-18 18.0 cm
16.0cm	PC 13-2929-16	PC 13-2930-16	PC 13-2931-16	PC 13-2932-16	PC 13-2933-16	PC 13-2934-16	
18.0cm	PC 13-2929-18	PC 13-2930-18	PC 13-2931-18	PC 13-2932-18	PC 13-2933-18	PC 13-2934-18	
23.0cm	PC 13-2929-23	PC 13-2930-23	PC 13-2931-23				

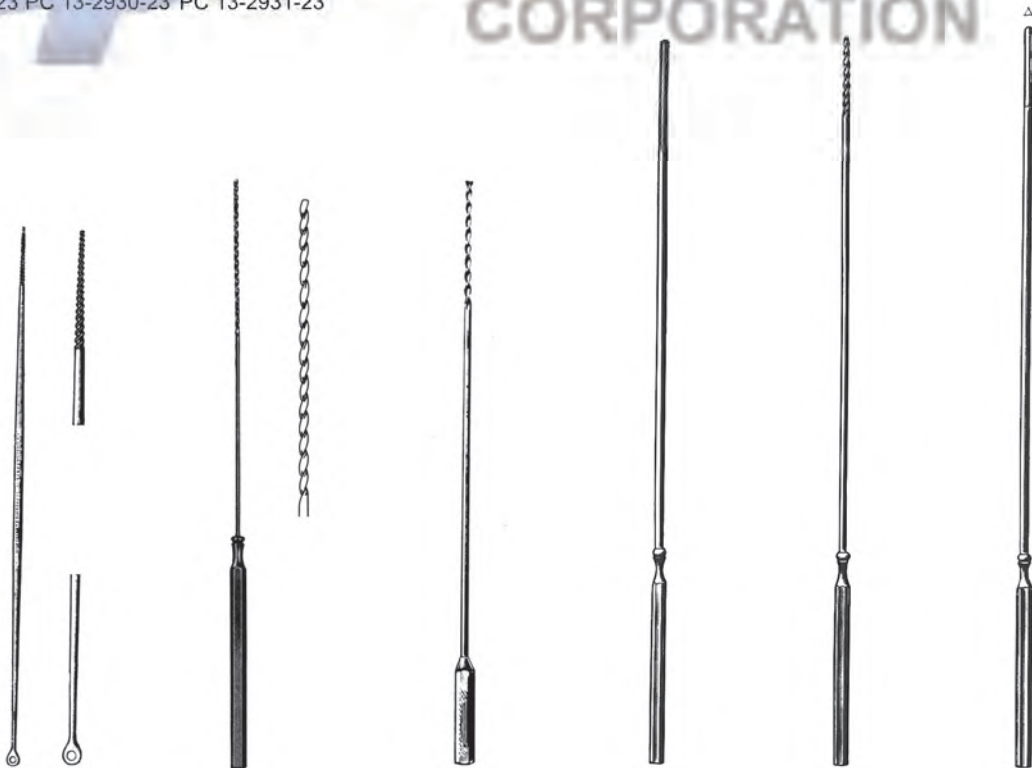

<b>JOBSON-HORNE</b>					
PC 13-2936-15	PC 13-2937-16	PC 13-2938-25	PC 13-2939-28	PC 13-2940-28	PC 13-2941-28
15.0 cm	16.0 cm	25.0 cm	28.0 cm	28.0 cm	28.0 cm

- EN —●— Sponge Holder  
 DE —●— Schwammhalter  
 ES —●— Porta-esponjas

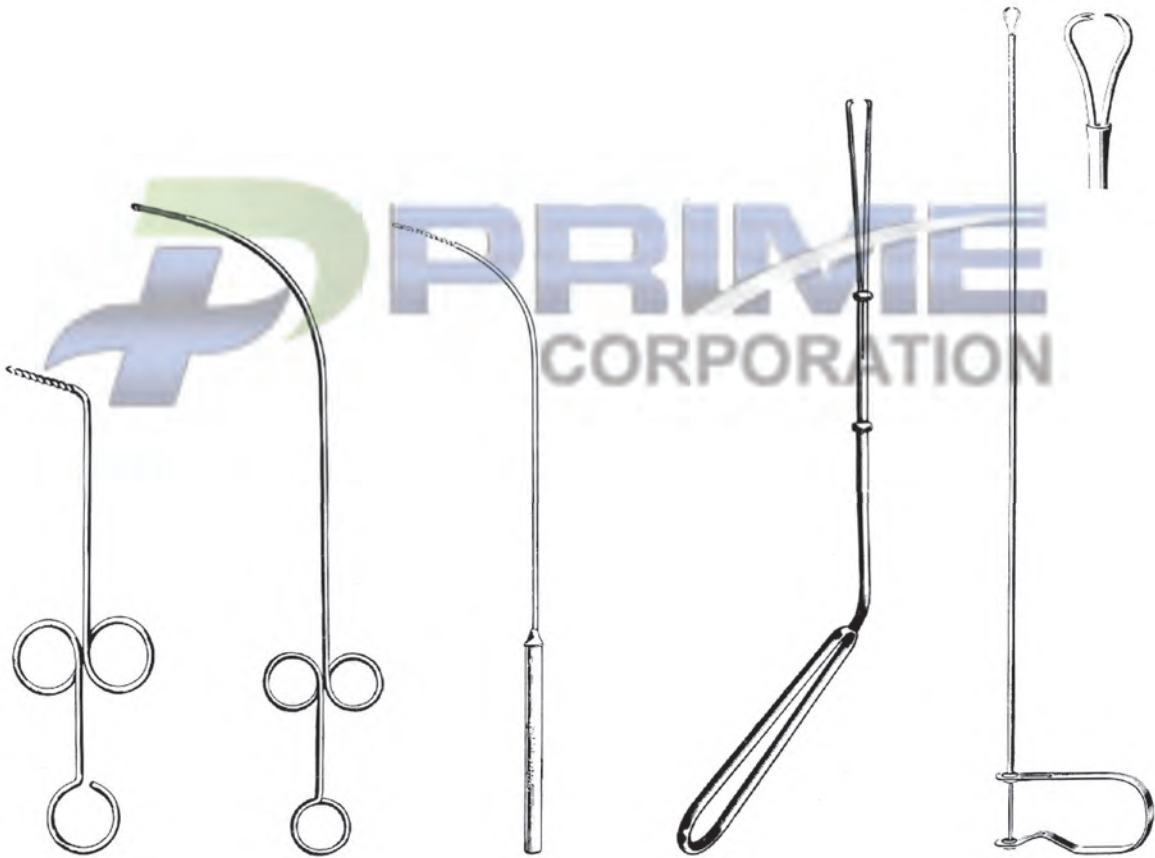

**HARTMANN**  
PC 13-2942-20  
20.0 cm

**FEIN**  
PC 13-2943-28  
28.0 cm

**TOBOLD**  
PC 13-2944-25  
25.0 cm

PC 13-2945-40  
40.0 cm

PC 13-2946-45  
45.0 cm

Vericose Vein Probe Set and Ring Strippers ●— EN  
 Krampfader-Besteck und Ringstripper ●— DE  
 Sonda para varices y desobliteradores de vasos ●— ES

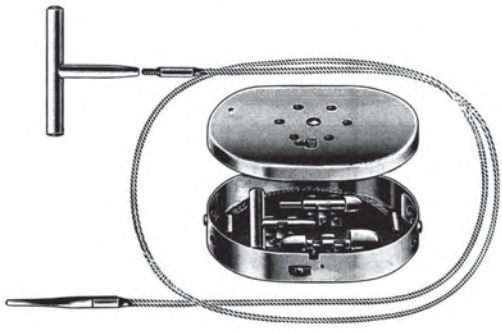

**NABATOFF**  
 PC 13-2947-00  
 complete set.  
 135 x 100 x 25mm

PC 13-2948-01

PC 13-2949-02



PC 13-2950-04



PC 13-2951-03  
3.0mm Ø



PC 13-2951-06  
6.0mm Ø



PC 13-2951-09  
9.0mm Ø



PC 13-2951-12  
12.0mm Ø

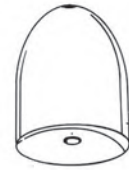

PC 13-2951-15  
15.0mm Ø



50.0 cm



PC 13-2952-12  
12.0 cm

PC 13-2953-50  
2.0mm Ø

PC 13-2954-50  
3.0mm Ø

PC 13-2955-50  
4.0mm Ø

PC 13-2956-50  
6.0mm Ø

PC 13-2957-50  
7.0mm Ø

PC 13-2958-50  
8.5mm Ø

PC 13-2959-50  
10.0mm Ø

PC 13-2960-50  
12.0mm Ø

PC 13-2961-50  
14.0mm Ø





**EN** Bone Surgery

**DE** Knochenchirurgie

**ES** Cirugía ósea

Page 170 to 268

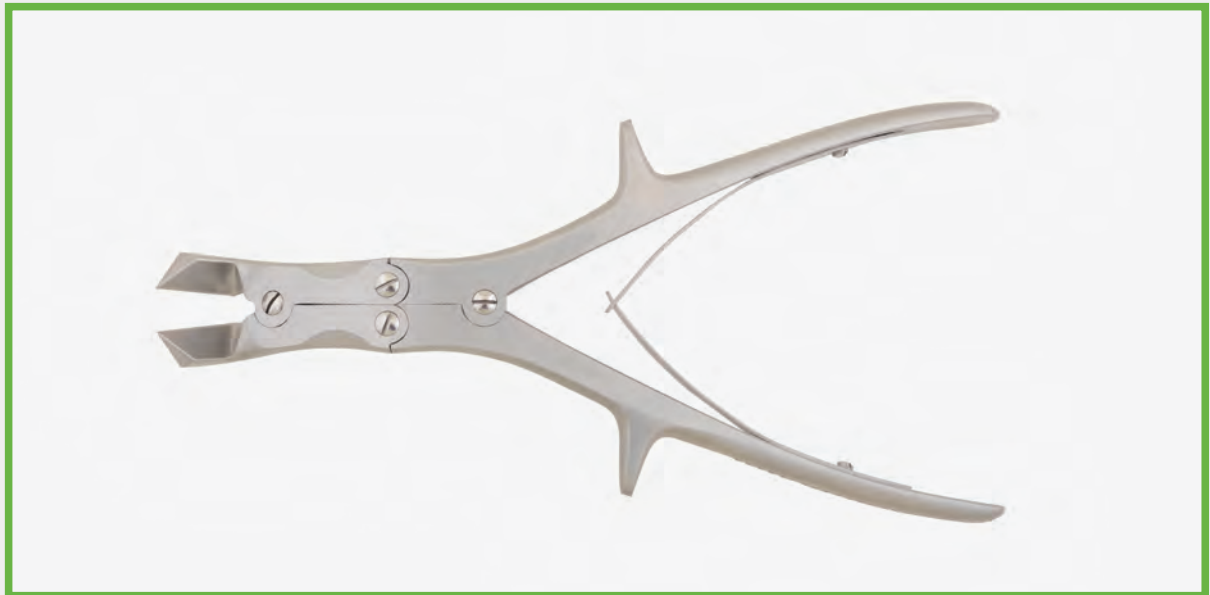

- EN —● Mallets
- DE —● Hämmer
- ES —● Martillos



**Mead**  
PC 14-3001-17 17 cm/6 ½"  
26mm Ø,320 g (11¼ oz)

**Partsch**  
PC 14-3002-18 18 cm/7"  
22mm Ø,200 g (7 oz)

PC 14-3003-30  
30mm Ø,510 g

PC 14-3004-26 250 g  
PC 14-3005-26 450 g  
26.5 cm/10 ¾"



PC 14-3006-18 18.5 cm/7 ½"  
25mm Ø 135 g



lead filled

PC 14-3007-19 19 cm/7 ¾"  
22mm Ø 155 g



**Hajek**  
PC 14-3008-22 22 cm/8 ¾"  
27mm Ø 130 g

Mallets ● EN  
 Hämmer ● DE  
 Martillos ● ES

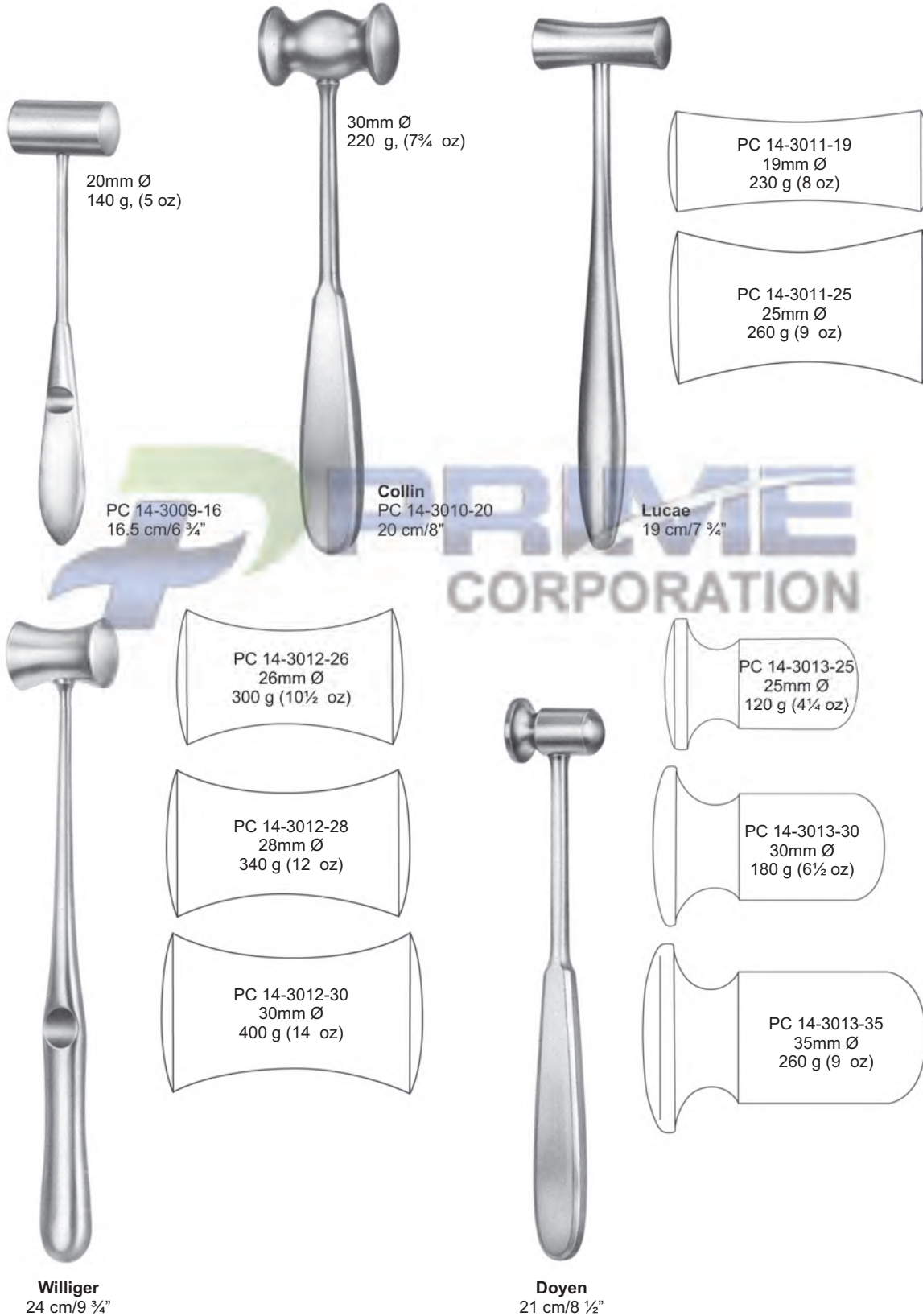

- EN —● Mallets
- DE —● Hämmer
- ES —● Martillos

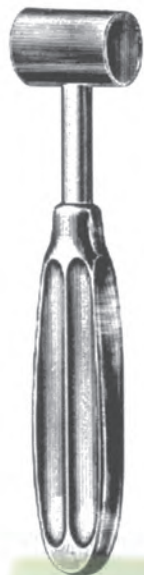

**Gerzog**  
PC 14-3014-18  
18 cm/7"  
250 g

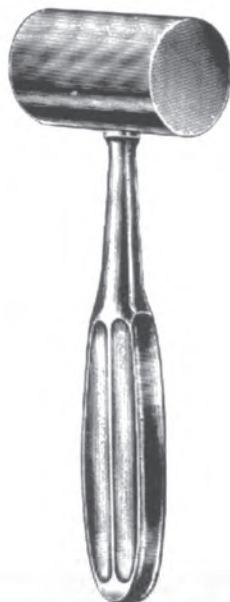

**Kirk**  
PC 14-3015-19  
19 cm/7 1/2"  
750 g

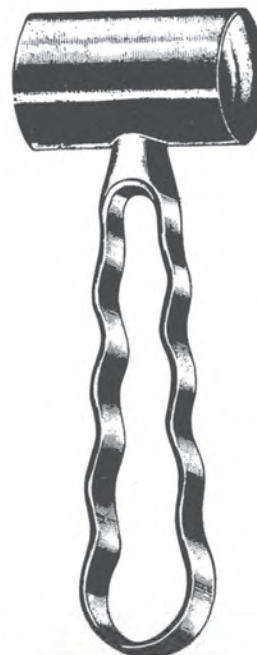

**Heath**  
18 cm/7"  
PC 14-3016-35 35mm Ø (28 oz)  
PC 14-3016-40 40mm Ø (36 oz)

42mm Ø

30mm Ø



PC 14-3020-00  
Spare Faces



PC 14-3017-26  
26.5 cm/10 1/2"  
530 g (19 oz)



PC 14-3018-24  
24 cm/9 1/2"  
(30mm Ø 480 g)



PC 14-3019-22  
22.5 cm/9"  
(37mm Ø 370 g)



PC 14-3020-24  
24 cm/9 1/2"



- Mallets ● — EN
- Hämmer ● — DE
- Martillos ● — ES



PC 14-3021-26 26.5 cm/10 ½"  
30mm Ø, 510 g (18 oz)

PC 14-3022-26  
26.5 cm/10 ½"

PC 14-3023-25 250 g (0.55 lbs)  
PC 14-3023-45 450 g (1 lbs)  
PC 14-3023-90 900 g (2 lbs)  
26.5 cm/10 ½"



Bone Chisels, Gauges ●— EN  
 Knochenmeißel, Hohlmeißel ●— DE  
 Cinceles, Gubias ●— ES



**Lexer**  
27.5 cm/10¾"

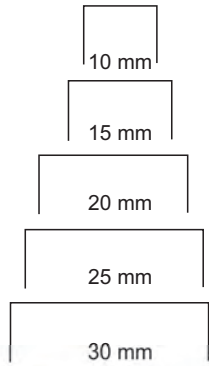

- PC 14-3036-10
- PC 14-3036-15
- PC 14-3036-20
- PC 14-3036-25
- PC 14-3036-30



- PC 14-3037-10
- PC 14-3037-15
- PC 14-3037-20
- PC 14-3037-25
- PC 14-3037-30



**Cloward**  
24 cm/9½"

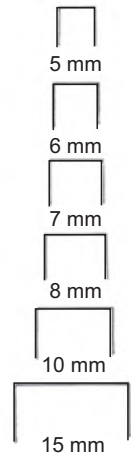

- PC 14-3038-05
- PC 14-3038-06
- PC 14-3038-07
- PC 14-3038-08
- PC 14-3038-10
- PC 14-3038-15



- PC 14-3039-05
- PC 14-3039-06
- PC 14-3039-07
- PC 14-3039-08
- PC 14-3039-10
- PC 14-3039-15

- EN —● Bone Chisels, Gauges
- DE —● Knochenmeißel, Hohlmeißel
- ES —● Cinceles, Gubias



PC 14-3040-10



PC 14-3041-10



PC 14-3042-10



PC 14-3043-10



BUCK-GRAMCKO  
10 cm/4"



BUCKLEY  
16 cm/6 1/2"



PC 14-3044-02  
2mm



PC 14-3044-03  
3mm



PC 14-3044-04  
4mm



- Bone Chisels, Gauges ●— EN
- Knochenmeißel, Hohlmeißel ●— DE
- Cinceles, Gubias ●— ES



EN —● Bone Chisels, Gauges  
 DE —● Knochenmeißel, Hohlmeißel  
 ES —● Cinceles, Gubias



Alexander  
18 cm/7"

	mm	
PC 14-3046-04	04	PC 14-3047-04
PC 14-3046-06	06	PC 14-3047-06
PC 14-3046-08	08	PC 14-3047-08
PC 14-3046-10	10	PC 14-3047-10
PC 14-3046-12	12	PC 14-3047-12
PC 14-3046-14	14	PC 14-3047-14

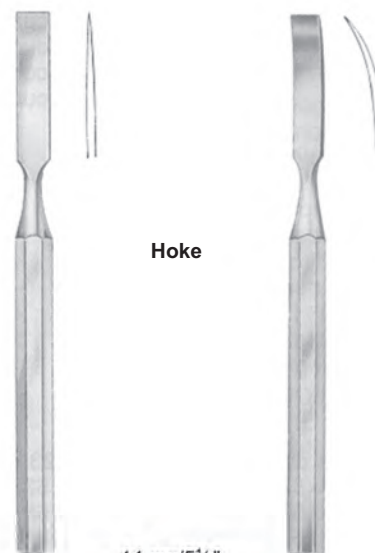

Hoke

14 cm/5½"

	mm	
PC 14-3048-02	2	PC 14-3049-02
PC 14-3048-03	3	PC 14-3049-03
PC 14-3048-04	4	PC 14-3049-04
PC 14-3048-05	5	PC 14-3049-05
PC 14-3048-06	6	PC 14-3049-06
PC 14-3048-07	7	PC 14-3049-07
PC 14-3048-08	8	PC 14-3049-08



Smith-Petersen  
20 cm/8"



mm				
06	PC 14-3050-06	PC 14-3051-06	PC 14-3052-06	PC 14-3053-06
09	PC 14-3050-09	PC 14-3051-09	PC 14-3052-09	PC 14-3053-09
13	PC 14-3050-13	PC 14-3051-13		
14			PC 14-3052-14	PC 14-3053-14
16	PC 14-3050-16	PC 14-3051-16	PC 14-3052-16	PC 14-3053-16
19	PC 14-3050-19	PC 14-3051-19	PC 14-3052-19	PC 14-3053-19
25	PC 14-3050-25	PC 14-3051-25	PC 14-3052-25	PC 14-3053-25
32	PC 14-3050-32	PC 14-3051-32	PC 14-3052-32	PC 14-3053-32

Bone Chisels, Gauges ●— EN  
 Knochenmeißel, Hohlmeißel ●— DE  
 Cinceles, Gubias ●— ES



Lambotte		
	mm	
PC 14-3054-04	04	PC 14-3055-04
PC 14-3054-06	06	PC 14-3055-06
PC 14-3054-08	08	PC 14-3055-08
PC 14-3054-10	10	PC 14-3055-10
PC 14-3054-13	13	PC 14-3055-13
PC 14-3054-16	16	PC 14-3055-16
PC 14-3054-18	18	PC 14-3055-18
PC 14-3054-20	20	PC 14-3055-20
PC 14-3054-25	25	PC 14-3055-25
PC 14-3054-30	30	PC 14-3055-30
PC 14-3054-38	38	PC 14-3055-38
PC 14-3054-44	44	PC 14-3055-44
PC 14-3054-50	50	PC 14-3055-50

24 cm/9½"

23 cm/9"

Curved



Mini-Lambotte		
	mm	
PC 14-3056-02	02	PC 14-3057-02
PC 14-3056-03	03	PC 14-3057-03
PC 14-3056-04	04	PC 14-3057-04
PC 14-3056-06	06	PC 14-3057-06
PC 14-3056-08	08	PC 14-3057-08
PC 14-3056-10	10	PC 14-3057-10
PC 14-3056-12	12	PC 14-3057-12
PC 14-3056-15	15	PC 14-3057-15
	12.5 cm/5"	17 cm/6¾"



Mini-Lexer		
	mm	
'C 14-3058-04	04	PC 14-3059-04
'C 14-3058-06	06	PC 14-3059-06
'C 14-3058-08	08	PC 14-3059-08
'C 14-3058-10	10	PC 14-3059-10
'C 14-3058-12	12	PC 14-3059-12

18 cm/7"



Str	Lexer mm	Cvd
PC 14-3060-05	05	PC 14-3061-05
PC 14-3060-07	07	PC 14-3061-07
PC 14-3060-10	10	PC 14-3061-10
PC 14-3060-15	15	PC 14-3061-15
PC 14-3060-20	20	PC 14-3061-20
PC 14-3060-25	25	PC 14-3061-25
PC 14-3060-30	30	PC 14-3061-30

22 cm/8¾"

- EN —● Bone Chisels, Gauges
- DE —● Knochenmeißel, Hohlmeißel
- ES —● Cinceles, Gubias

Gouge for the  
removing of  
broken screws



**Chisel**  
PC 14-3062-20  
24.5 cm/9¾"  
20 mm



**Chisel-Curved**  
PC 14-3063-20  
26.5 cm/10½"  
20 mm



PC 14-3064-22  
22 cm/8¾"



Bone Chisels, Gauges ●— EN  
 Knochenmeißel, Hohlmeißel ●— DE  
 Cinceles, Gubias ●— ES



**Zielke**  
 23 cm/9"  
 5.5 mm  
 9.0 mm

PC 14-3065-05  
 PC 14-3065-09

**Stille**  
 20 cm/8"



Width

mm	PC 14-3066-06	PC 14-3067-06	PC 14-3068-06	PC 14-3069-06	PC 14-3070-06
06	PC 14-3066-06	PC 14-3067-06	PC 14-3068-06	PC 14-3069-06	PC 14-3070-06
08	PC 14-3066-08	PC 14-3067-08	PC 14-3068-08	PC 14-3069-08	PC 14-3070-08
10	PC 14-3066-10	PC 14-3067-10	PC 14-3068-10	PC 14-3069-10	PC 14-3070-10
12	PC 14-3066-12	PC 14-3067-12	PC 14-3068-12	PC 14-3069-12	PC 14-3070-12
15	PC 14-3066-15	PC 14-3067-15	PC 14-3068-15	PC 14-3069-15	PC 14-3070-15
20	PC 14-3066-20	PC 14-3067-20	PC 14-3068-20	PC 14-3069-20	PC 14-3070-20
25	PC 14-3066-25	PC 14-3067-25	PC 14-3068-25	PC 14-3069-25	PC 14-3070-25
30	PC 14-3066-30	PC 14-3067-30	PC 14-3068-30	PC 14-3069-30	PC 14-3070-30

CORPORATION



**Hibbs**  
 24 cm/9 1/2"

mm	PC 14-3071-06	PC 14-3072-06	PC 14-3073-06	PC 14-3074-06	PC 14-3075-06
06	PC 14-3071-06	PC 14-3072-06	PC 14-3073-06	PC 14-3074-06	PC 14-3075-06
09	PC 14-3071-09	PC 14-3072-09	PC 14-3073-09	PC 14-3074-09	PC 14-3075-09
13	PC 14-3071-13	PC 14-3072-13	PC 14-3073-13	PC 14-3074-13	PC 14-3075-13
16	PC 14-3071-16	PC 14-3072-16	PC 14-3073-16	PC 14-3074-16	PC 14-3075-16
19	PC 14-3071-19	PC 14-3072-19	PC 14-3073-19	PC 14-3074-19	PC 14-3075-19
25	PC 14-3071-25	PC 14-3072-25	PC 14-3073-25	PC 14-3074-25	PC 14-3075-25
32	PC 14-3071-32	PC 14-3072-32	PC 14-3073-32	PC 14-3074-32	PC 14-3075-32

- EN —● Bone Chisels, Gauges
- DE —● Knochenmeißel, Hohlmeißel
- ES —● Cinceles, Gubias



mm **Lexer**  
 05 PC 14-3076-05  
 10 PC 14-3076-10  
 15 PC 14-3076-15

28 cm/11"



**Lexer**  
 PC 14-3077-05  
 PC 14-3077-10  
 PC 14-3077-15

25 cm/10"



**Lexer**  
 PC 14-3078-05  
 PC 14-3078-10  
 PC 14-3078-15

25 cm/10"



PC 14-3079-01



PC 14-3079-02



PC 14-3079-03



**Cobb**  
 28 cm/11" PC 14-3079-04

Bone Files ● EN  
Knochenfeile ● DE  
Lima para huesos ● ES



**Putti**  
PC 14-3080-30  
30 cm/12"



**Putti**  
PC 14-3081-27  
27 cm/10½"



PC 14-3082-28  
28 cm/11"



PC 14-3083-24  
24 cm/9½"



PC 14-3084-22  
22 cm/8¾"



- EN —● Bone Files
- DE —● Knochenfeile
- ES —● Lima para huesos

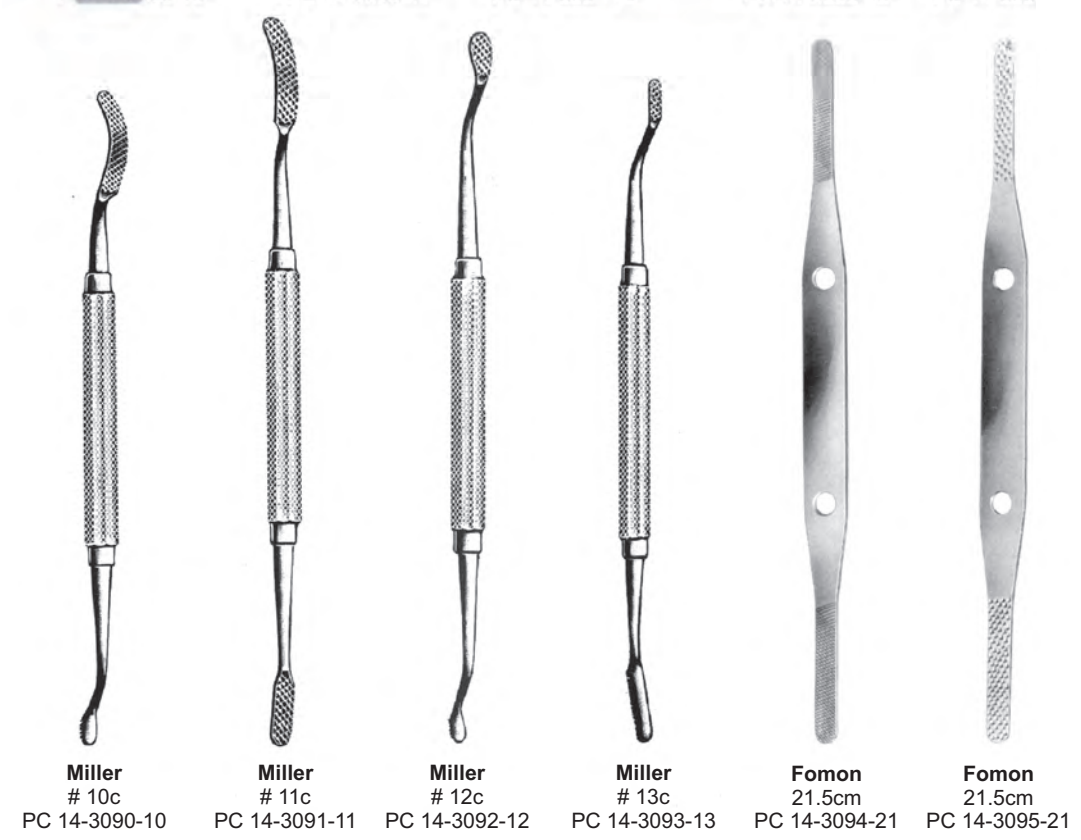
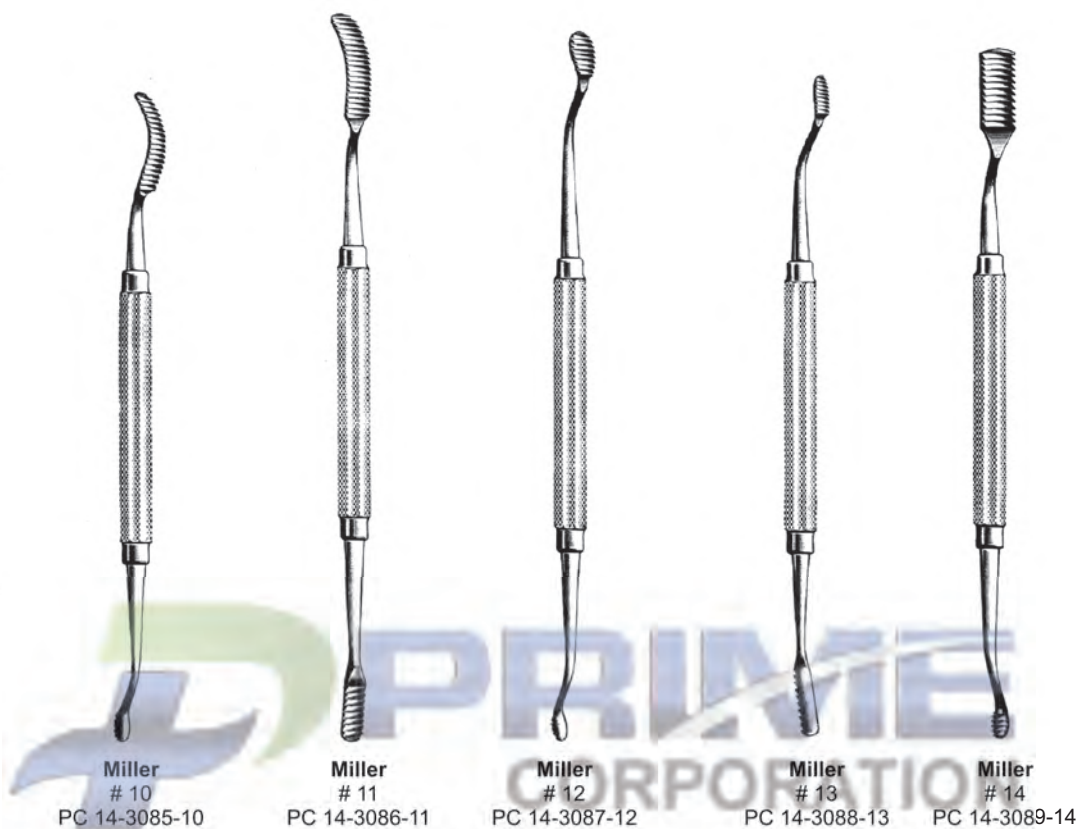



Periosteal Raspatories ●— EN  
 Raspatorien ●— DE  
 Legras periostotomos ●— ES

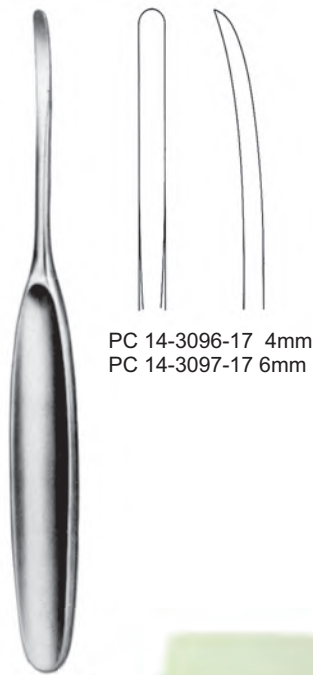

PC 14-3096-17 4mm  
 PC 14-3097-17 6mm

**CUSHING**  
 17 cm/8 1/2"

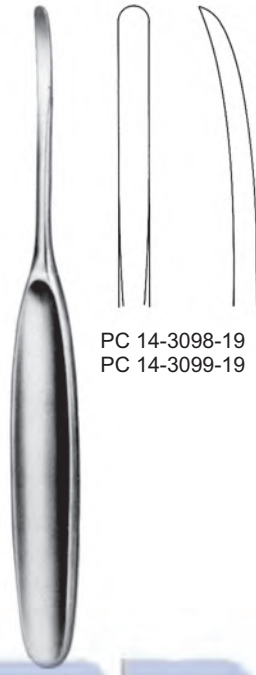

PC 14-3098-19 5mm  
 PC 14-3099-19 7mm

**CUSHING**  
 19.5 cm/7 3/4"

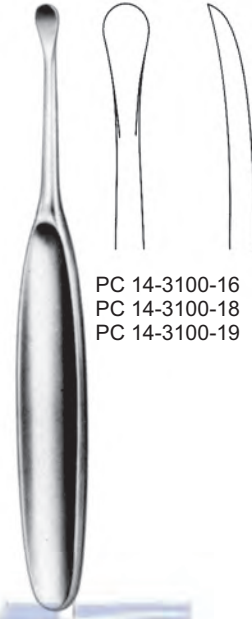

PC 14-3100-16 7mm, 16 cm/6 1/2"  
 PC 14-3100-18 15mm, 18.5 cm/7 1/2"  
 PC 14-3100-19 20mm, 19 cm/7 3/4"

**HOEN**

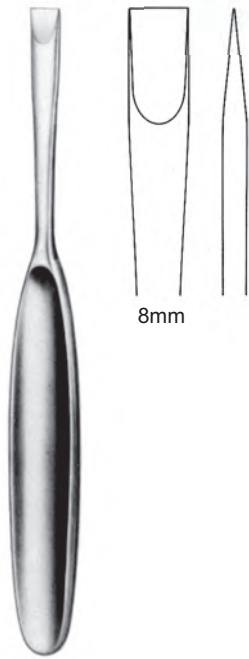

**CUSHING**  
 PC 14-3101-17  
 17 cm/6 3/4"

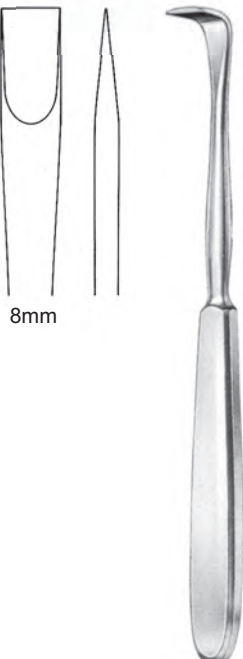

**LANGENBECK**  
 PC 14-3102-18  
 18 cm/7"

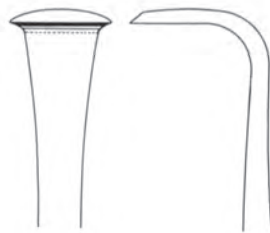

**LANGENBECK**  
 PC 14-3103-19  
 19 cm/7 3/4"



PC 14-3104-05  
 5mm  
 PC 14-3104-06  
 6mm  
 PC 14-3104-33  
 7mm  
 16 cm/6 1/2"

- EN —● Bone Chisels, Gauges
- DE —● Knochenmeißel, Hohlmeißel
- ES —● Cinceles, Gubias



**Lambotte**  
21 cm/8¼"

Width

- mm
- PC 14-3105-21 05
- PC 14-3106-21 10
- PC 14-3107-21 15
- PC 14-3108-21 20
- PC 14-3109-21 25



**Schneider**  
PC 14-3110-17  
13 mm  
17.5 cm/7"



**Schneider-Sauerbruch**  
PC 14-3111-19  
13 mm  
19 cm/7½"

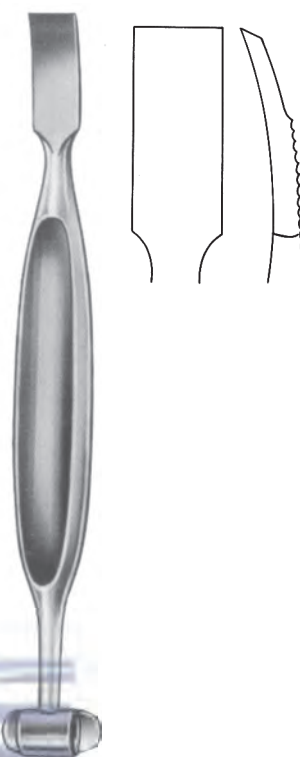

**Alexander**  
PC 14-3112-20  
20 cm/8"



**Jansen**  
PC 14-3113-16  
15 mm  
16.5 cm/6½"



**Seldin**  
PC 14-3114-19  
19 cm/7½"



**Davidson-Alexander**  
PC 14-3115-29  
29 cm/11½"



**Williger**  
PC 14-3116-13  
13 cm/5"

- Periosteal Elevators ●— EN
- Raspatorien ●— DE
- Periostótomos ●— ES

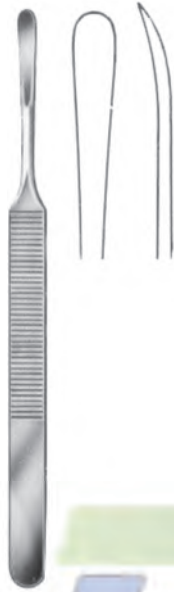

**König**  
PC 14-3117-15  
15.5 cm/6"  
5 mm



**Williger**  
PC 14-3118-16  
16 cm/6¼"



**Adson**  
17 cm/6¾"



PC 14-3119-17 PC 14-3120-17



PC 14-3121-17 PC 14-3122-17



PC 14-3123-17 17 cm/6¾"  
6 mm PC 14-3124-17  
8 mm

- EN —● Bone Chisels, Gauges
- DE —● Knochenmeißel, Hohlmeißel
- ES —● Cinceles, Gubias



**Farabeuf**  
PC 14-3125-15  
15 cm/6"

**Farabeuf**  
PC 14-3126-15  
15 cm/6"

**Farabeuf-Collin**  
PC 14-3127-15  
15.5 cm/6"  
11 mm

**Farabeuf-Collin**  
PC 14-3128-15  
15.5 cm/6"  
11 mm

**Farabeuf**  
PC 14-3129-19  
19 cm/7 1/2"  
13 mm



**Sedillot**  
PC 14-3130-18  
18 cm/7"  
18 mm



**Sedillot**  
PC 14-31301-21  
21 cm/8 1/4"  
15 mm



**LANGENBECK**

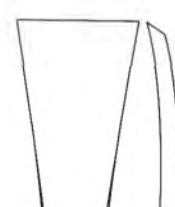

PC 14-3132-19  
19.0cm, 16mm

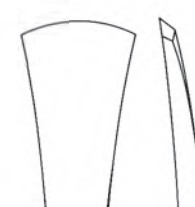

PC 14-3133-19  
19.0cm, 16cm



PC 14-3134-19  
19.0cm, 12mm



PC 14-3135-18  
18.0cm, 12mm



- Periosteal Elevators ●— EN
- Raspatorien ●— DE
- Periostótomos ●— ES



- EN —● Periosteal Elevators
- DE —● Raspatorien
- ES —● Periostótomos

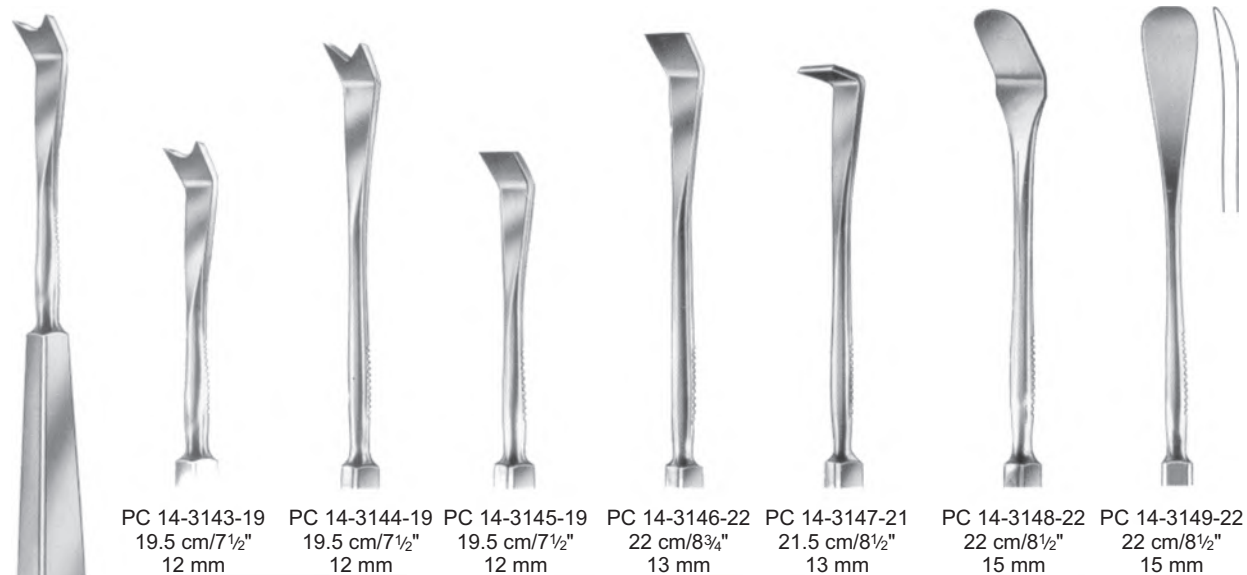

Semb



Doyen  
17 cm/6¾"

Doyen  
PC 14-3154-24 24 cm/9½" PC 14-3155-24

Periosteal Elevators ●— EN  
Raspatorien ●— DE  
Periostótomos ●— ES

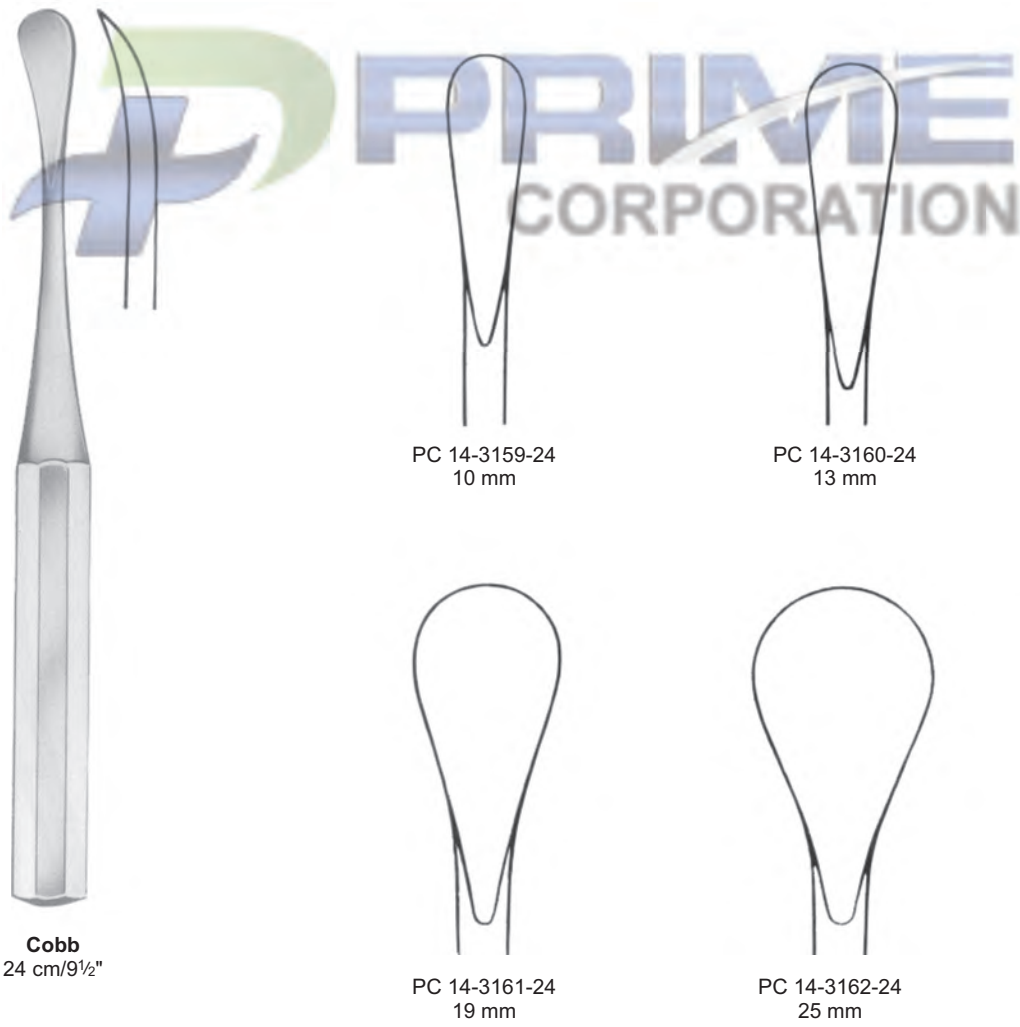
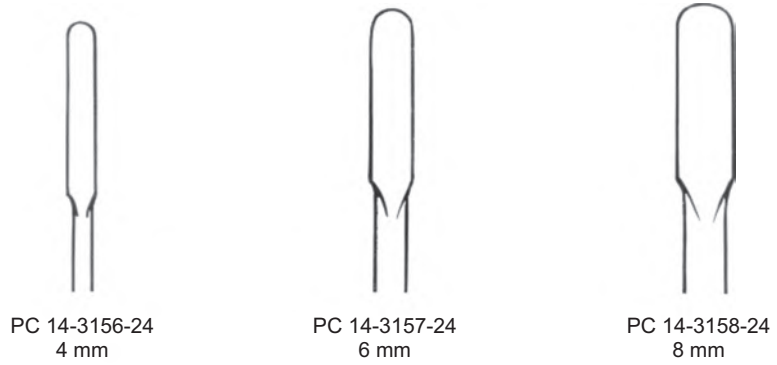

- EN —● Periosteal Elevators
- DE —● Raspatorien
- ES —● Periotómos



PC 14-3163-19  
19 cm/7½"  
6 mm



PC 14-31634-18  
18.5 cm/7¼"  
3 mm



PC 14-3165-18  
18.5 cm/7¼"  
6 mm



PC 14-3166-18  
18.5 cm/7¼"  
6 mm

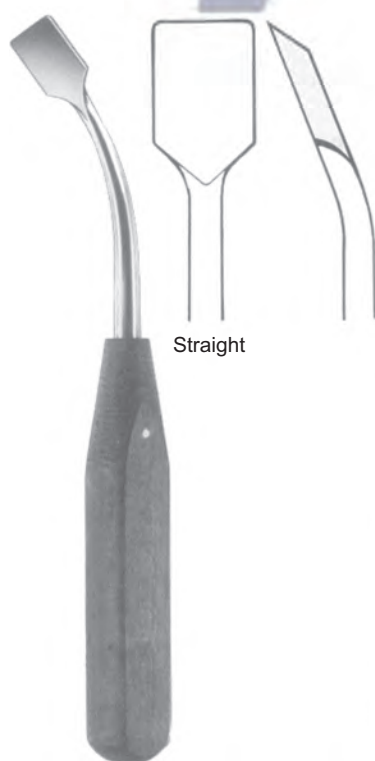

PC 14-3167-18  
18.5 cm/7¼"  
13 mm



PC 14-3168-19  
19.5 cm/7¾"  
14 mm



PC 14-3169-18  
18.5 cm/7¼"  
14 mm



PC 14-3170-20  
20 cm/8"  
20 mm



Periosteal Elevators ●— EN  
 Raspatorien ●— DE  
 Periostótomos ●— ES



PC 14-3171-27  
 27.5 cm/10¾"  
 20 mm

**Wagner**  
 8 mm PC 14-3172-33  
 17 mm PC 14-3173-33  
 33 cm/13"

**Cobb**  
 24 cm 28 cm  
 10 mm PC 14-3174-24 PC 14-3179-28  
 13 mm PC 14-3175-24 PC 14-3180-28  
 19 mm PC 14-3176-24 PC 14-3181-28  
 25 mm PC 14-3177-24 PC 14-3182-28  
 32 mm PC 14-3178-24 PC 14-3183-28

**Cobb**  
 08 mm PC 14-3184-28  
 10 mm PC 14-3185-28  
 12 mm PC 14-3186-28  
 28 cm/11"

**Cobb**  
 27.0cm  
 PC 14-3187-27 4mm  
 PC 14-3188-27 6mm  
 PC 14-3189-27 8mm

- EN —● Elevators
- DE —● Elevatorien
- ES —● Elevadores



PC 14-3190-16  
16 cm/6¼"  
7 mm

PC 14-3190-18  
18.5 cm/7¼"  
15 mm

PC 14-3190-19  
19 cm/7½"  
20 mm

Hoen



Yankauer  
PC 14-3191-18  
18 cm/7"



Langenbeck  
PC 14-3192-20  
20 cm/8"  
8 mm



Langenbeck  
PC 14-3193-20  
20 cm/8"  
10 mm



Langenbeck  
PC 14-3194-23  
23 cm/9"  
11 mm



Mass. Gen. Hosp.  
PC 14-3195-15  
15 cm/6"



Quervain  
PC 14-3196-20  
20 cm/8"

Elevators ●— EN  
 Elevatorien ●— DE  
 Elevadores ●— ES



PC 14-3197-16  
16 cm/6¼"

Width	Key	
6 mm	PC 14-3198-19	19 cm/7½"
12 mm	PC 14-3199-19	19 cm/7½"
19 mm	PC 14-3200-19	19 cm/7½"
25 mm	PC 14-3201-19	19 cm/7½"

**Konig**  
PC 14-3202-15  
15 cm/6"  
4.5 mm

**Konig**  
PC 14-3203-15  
15 cm/6"  
4.5 mm



**Alderdyce**  
PC 14-3204-21  
21 cm/8¼"

**McDonald**  
PC 14-3205-19  
19 cm/7½"

**Watson-Cheyne**  
PC 14-3206-17  
17.5 cm/7"



**Sebilleau**  
PC 14-3207-17  
17 cm/6¾"

- EN —● Elevators
- DE —● Elevatorien
- ES —● Elevadores

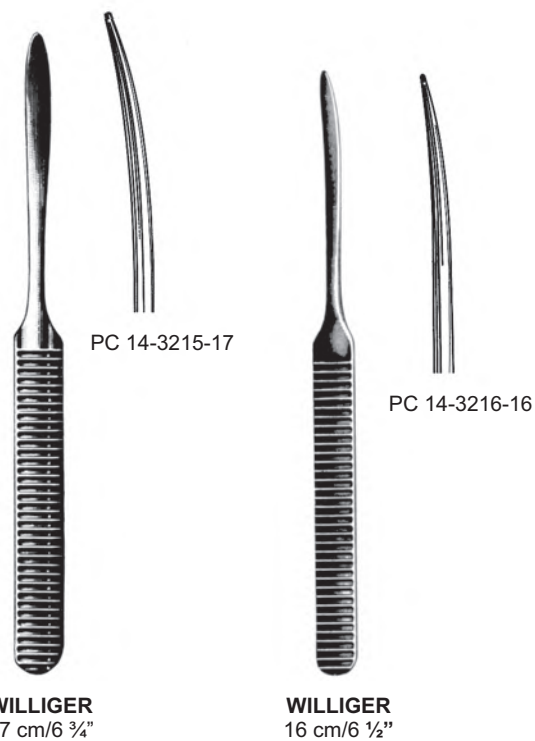
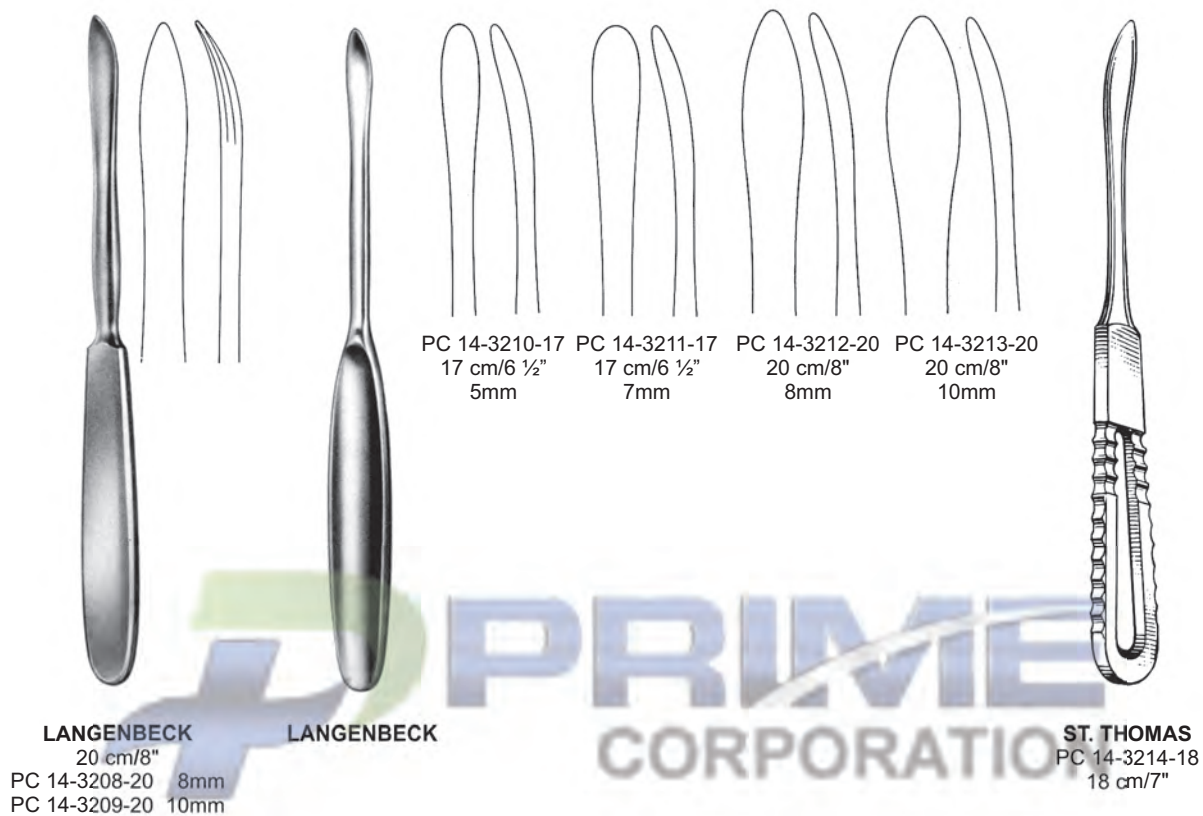



Bone Levers ● EN  
 Knochenhebel ● DE  
 Elevadores para huesos ● ES



**LANE**  
 PC 14-3217-26  
 26.5 cm/10 ½"

**LANE TRETHOWAN**  
 PC 14-3218-21  
 21.5 cm/8 ½"

**LANE**  
 PC 14-3219-25  
 25.5 cm/10"

**BRISTOW**  
 PC 14-3220-23  
 23 cm/9"

**MURPHY-LANE**  
 PC 14-3221-34  
 34 cm/11 ½"

- EN —● Elevators
- DE —● Elevatorien
- ES —● Elevadores

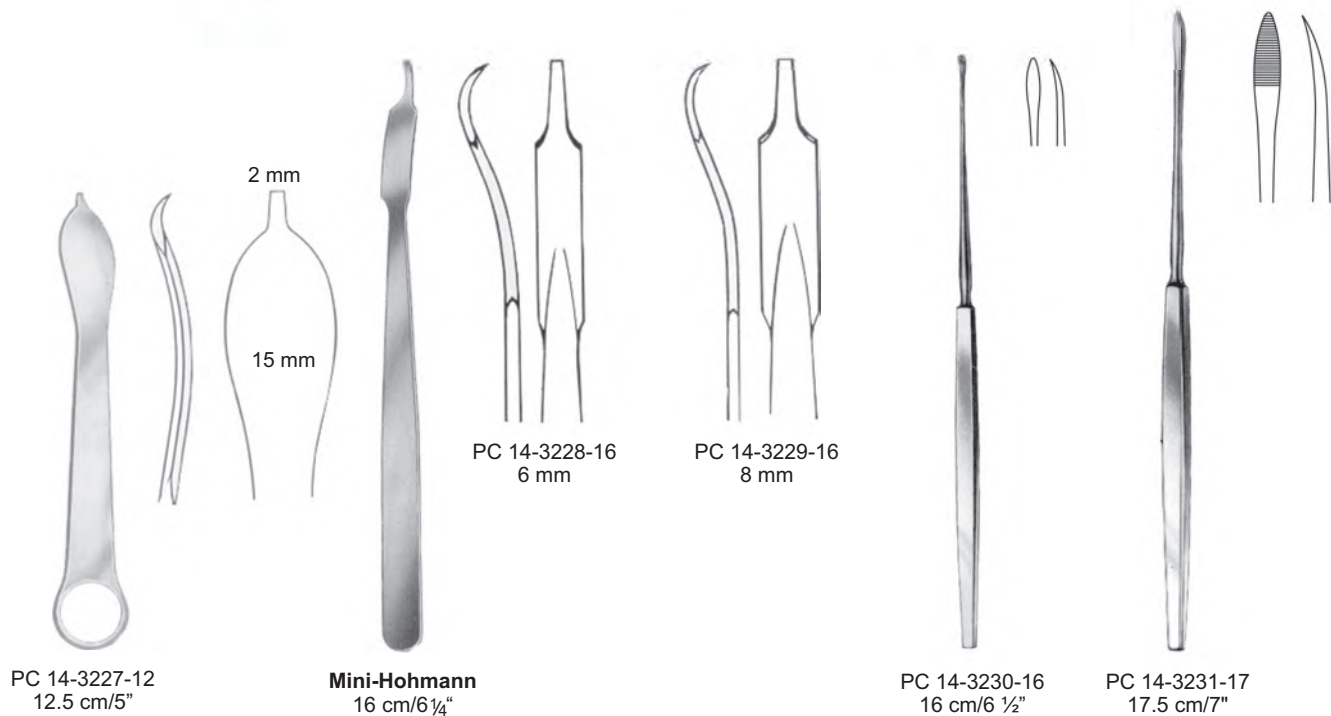

Bone Levers ● EN  
 Knochenhebel ● DE  
 Elevadores para huesos ● ES



PC 14-3236-17  
17 mm

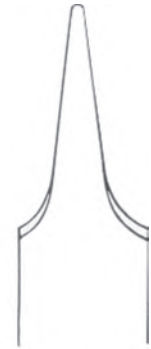

PC 14-3237-17  
17 mm



PC 14-3232-26  
26.5 cm/10½"  
24 mm



**Lange-Hohmann**  
PC 14-3233-26  
26 cm/10¼"  
22 mm



**Hohmann**  
PC 14-3234-22  
22 cm/8¾"  
8 mm



**Hohmann**  
PC 14-3235-24  
24 cm/9½"  
14mm

EN —● Elevators  
 DE —● Elevatorien  
 ES —● Elevadores



**Hohmann**  
 PC 14-3238-26  
 26 cm/10¼"  
 22 mm

**Hohmann**  
 PC 14-3239-28  
 28 cm/11"  
 33 mm

**Hohmann**  
 PC 14-3240-24  
 24 cm/9½"  
 43 mm

**Hohmann**  
 PC 14-3241-24  
 24.5 cm/9¾"  
 43 mm

**Hohmann**  
 PC 14-3242-24  
 24 cm/9½"  
 70 mm

**Hohmann**  
 PC 14-3243-22  
 22 cm/8¾"  
 18 mm



Bone Levers ●— EN  
 Knochenhebel ●— DE  
 Elevadores para huesos ●— ES



**Lange-Hohmann modif**  
 30 mm PC 14-3244-26 26.5 cm/10 1/2"  
 33 mm PC 14-3244-29 29.0 cm/11 1/2"

**Hohmann-Aldinger**  
 PC 14-3245-27  
 27 cm/10 1/2"

**Schumacher**  
 (Wagner)  
 PC 14-3246-34  
 34.5 cm/13 1/2"

**Schumacher**  
 PC 14-3247-29  
 29 cm/11 1/2"

- EN —• Elevators
- DE —• Elevatorien
- ES —• Elevadores



Smillie  
14 cm/5½"

PC 14-3248-14  
32 x19 mm

PC 14-3249-14  
48 x19 mm

PC 14-3250-14  
57 x19 mm



PC 14-3251-14  
52 x13 mm



PC 14-3252-14  
12 x13 mm



Spinal retractors



PC 14-3253-17  
75x30 mm

PC 14-3254-17  
100x30 mm

**Taylor**  
17 cm/6½"



PC 14-3255-21  
21.5 cm/8½"

Meniscus retractors



**Blount**  
PC 14-3256-17  
17.5 cm/7"

Bone Levers ●— EN  
 Knochenhebel ●— DE  
 Elevadores para huesos ●— ES



**Murphy-Lane**  
 PC 14-3257-32  
 32 cm/12½"



**Chandler**

Length	Width	
18 cm	13 mm	PC 14-3258-18
20 cm	19 mm	PC 14-3258-20
23 cm	25 mm	PC 14-3258-23
25 cm	30 mm	PC 14-3258-25



**Lange-Hohmann**

PC 14-3259-27	27 cm/10 ½"
PC 14-3260-29	29 cm/11 ½"



**Bennett**

PC 14-3261-24	24 cm/8 ½"
PC 14-3262-26	26 cm/10 ½"



**Blount**  
 PC 14-3263-26  
 26 cm/10¼"



**Blount**  
 PC 14-3264-26  
 26 cm/10¼"



PC 14-3265-24 44 mm  
 PC 14-3266-24 64 mm  
**Bennett**  
 24 cm/9½"



PC 14-3267-17  
 17 cm/6 ¾", 56x10mm  
 Retractor

- EN —● Meniscotomy Knives
- DE —● Meniskotome
- ES —● Bisturries para meniscos

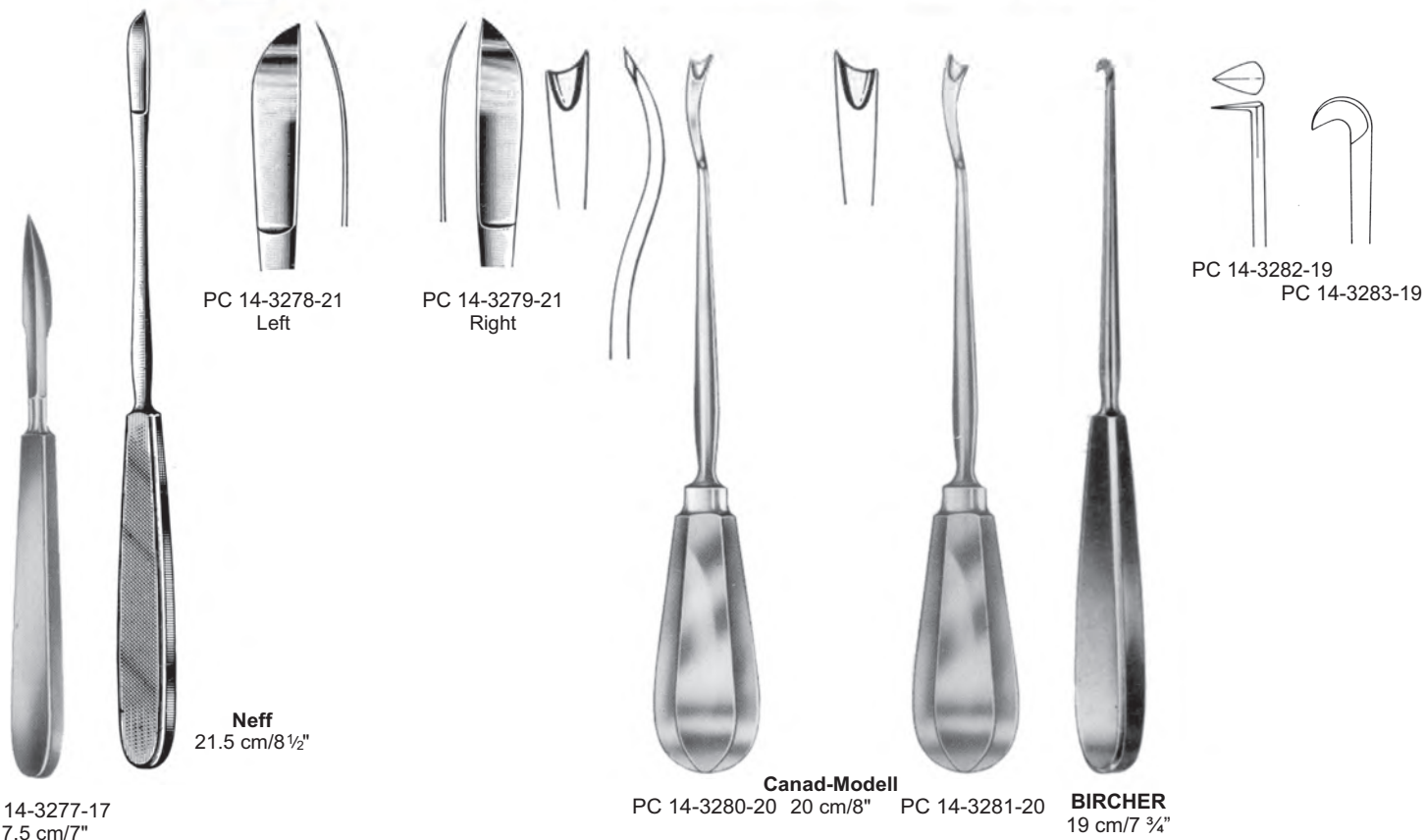



Hand Drills ●— EN  
 Handbohrapparate ●— DE  
 Perforadores de mano ●— ES

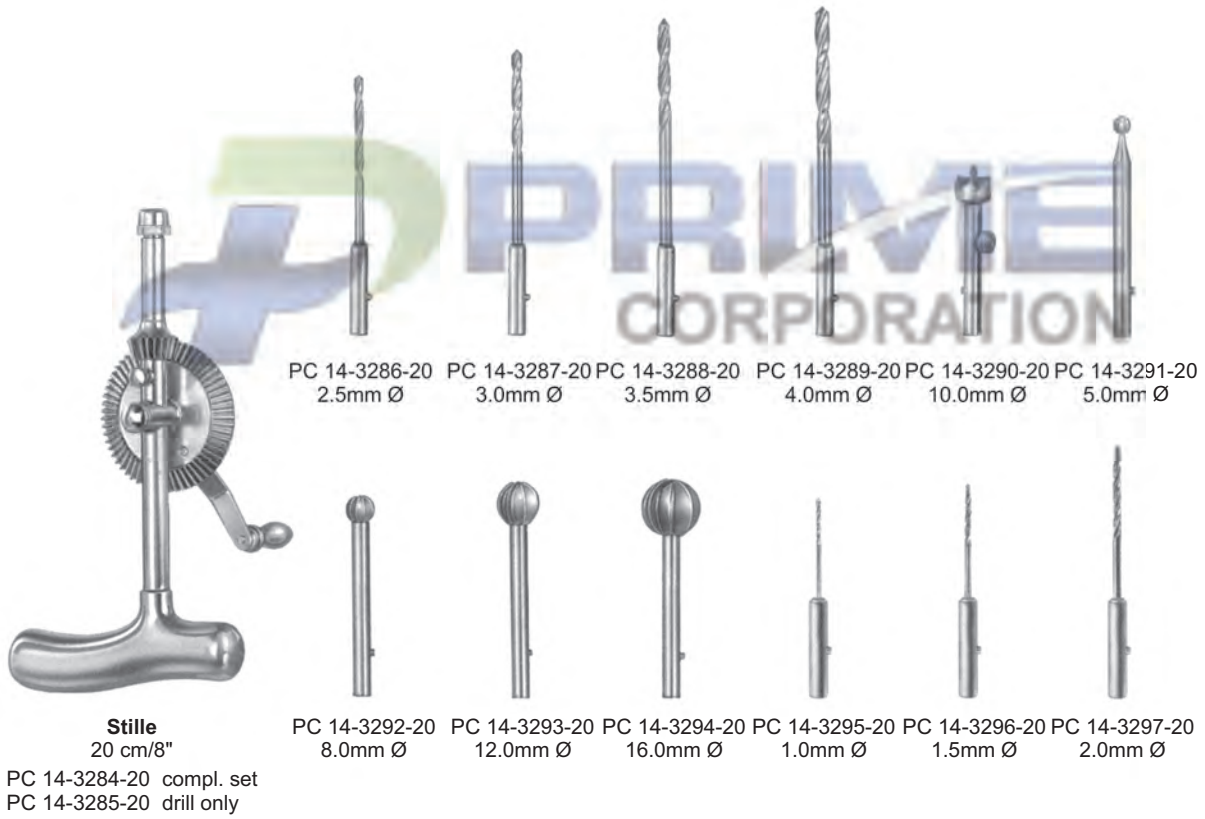

- EN —● Hand Drills
- DE —● Handbohrapparate
- ES —● Perforadores de mano

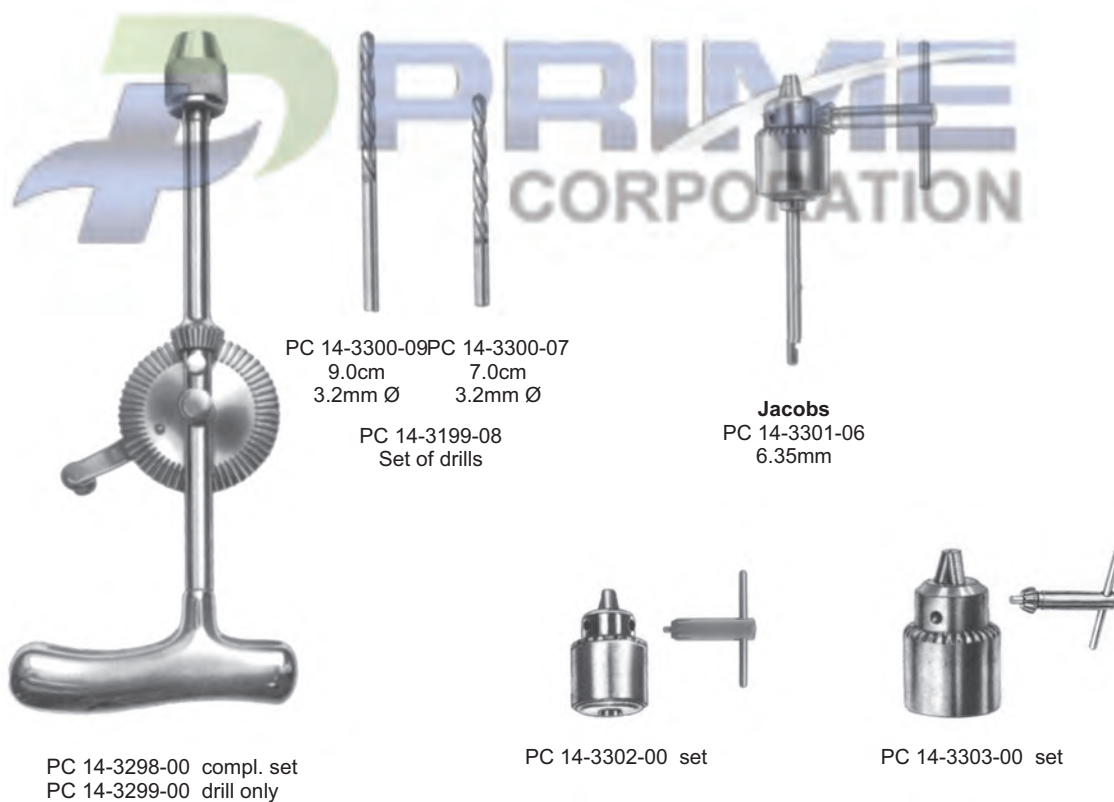

PC 14-3300-09 9.0cm 3.2mm Ø  
 PC 14-3300-07 7.0cm 3.2mm Ø

PC 14-3199-08  
 Set of drills

**Jacobs**  
 PC 14-3301-06  
 6.35mm

PC 14-3298-00 compl. set  
 PC 14-3299-00 drill only

PC 14-3302-00 set

PC 14-3303-00 set

Hand Drills ●— EN  
 Handbohrapparate ●— DE  
 Perforadores de mano ●— ES



**Stille-Sherman**  
 24 cm/9 3/4"  
 PC 14-3304-24 compl. set  
 PC 14-3305-24 drill only



PC 14-3306-24 2.5mm Ø    PC 14-3307-24 3.0mm Ø    PC 14-3308-24 3.5mm Ø



**Hudson**  
 PC 14-3309-00 compl. set / 6  
 (PC 14-3311-00,01,  
 02,03,07,09)  
 PC 14-3310-00  
 handle only



PC 14-3312-09 9mm Ø    PC 14-3313-14 14mm Ø    PC 14-3314-16 16mm Ø    PC 14-3315-22 22mm Ø



**Cushing** PC 14-3316-14 14mm Ø    **PC 14-3317-02** 2mm Ø    **Mckenzie** PC 14-3318-13 13mm Ø    **Errico** PC 14-3319-16 16mm Ø    PC 14-3320-00

- EN —● Hand Drills
- DE —● Handbohrapparate
- ES —● Perforadores de mano



PC 14-3321-00



PC 14-3322-00



PC 14-3323-00



PC 14-3325-00

PC 14-3324-00 complete set



**Kirschner**  
PC 14-3326-00 complete set



PC 14-3328-00



PC 14-3329-00



PC 14-3327-00



Hand Drills ●— EN  
Handbohrapparate ●— DE  
Perforadores de mano ●— ES

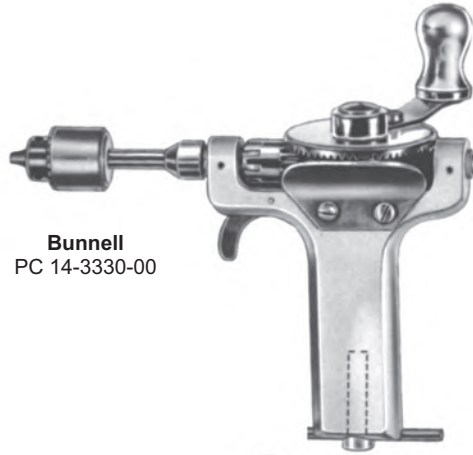

**Bunnell**  
PC 14-3330-00



**Ralk**  
PC 14-3331-00

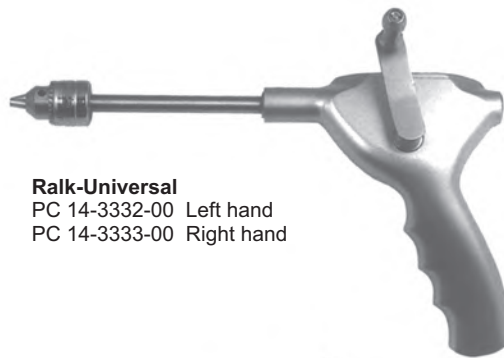

**Ralk-Universal**  
PC 14-3332-00 Left hand  
PC 14-3333-00 Right hand

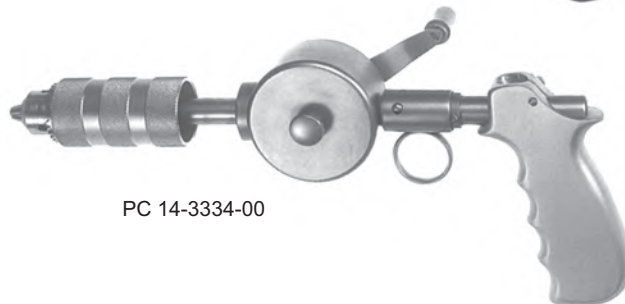

PC 14-3334-00

- EN —● Amputating and Resection Saws
- DE —● Amputations- und Resektionssägen
- ES —● Sierras para amputación y resección

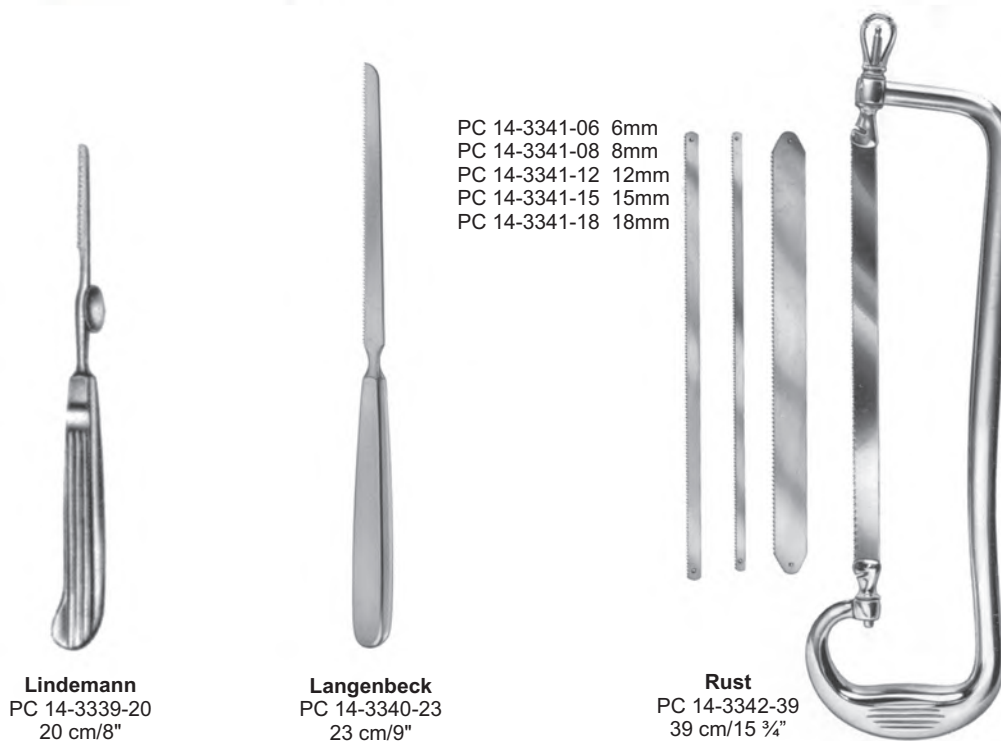
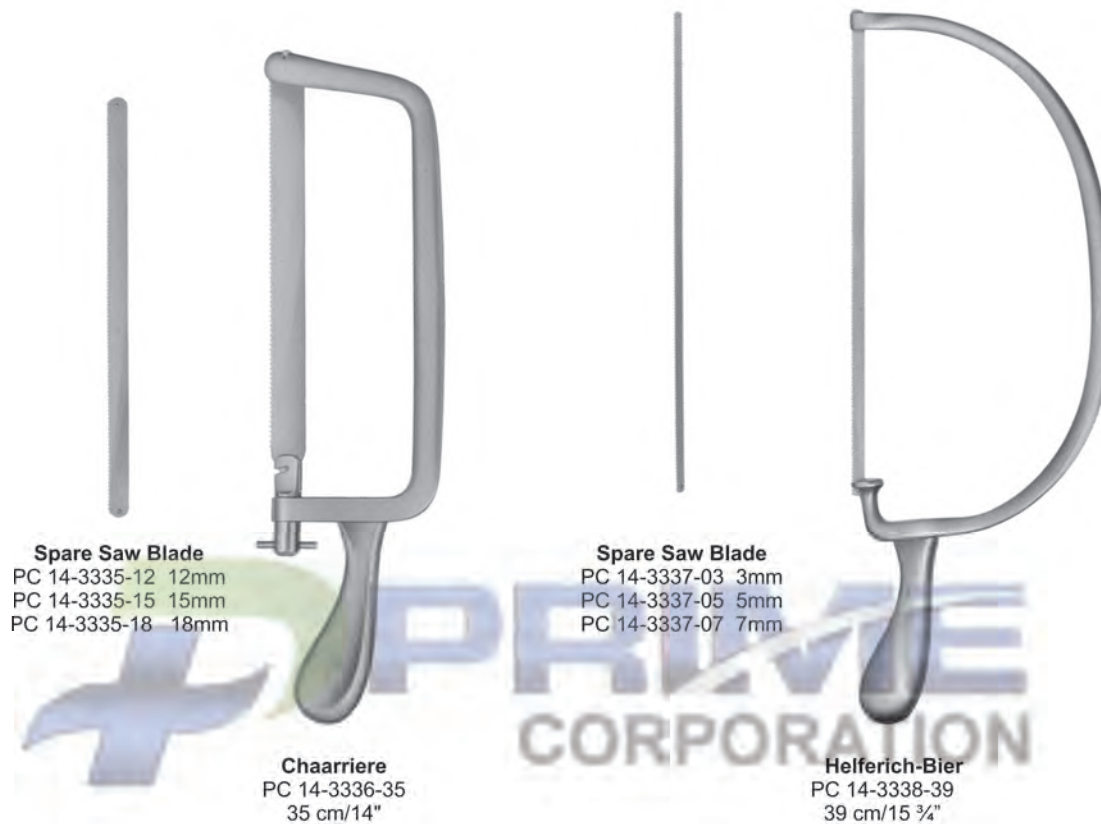

Amputating and Resection Saws ● EN  
 Amputations- und Resektionssägen ● DE  
 Sierras para amputación y resección ● ES



**Charriere**  
 PC 14-3343-27 27 cm/11"  
 PC 14-3343-30 30 cm/12"  
 PC 14-3343-34 33 cm/13"



**Satterlee**  
 PC 14-3344-31  
 31 cm/12 1/2"



**Charriere**  
 PC 14-3345-27 27 cm/11"  
 PC 14-3345-30 30 cm/12"



**Satterlee**  
 PC 14-3346-31  
 31 cm/12 1/2"

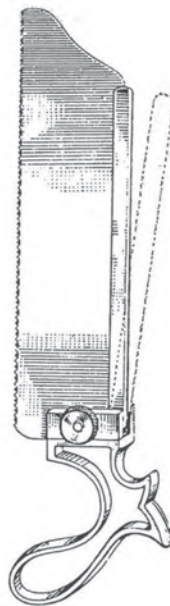

PC 14-3347-23  
 23 cm/9"

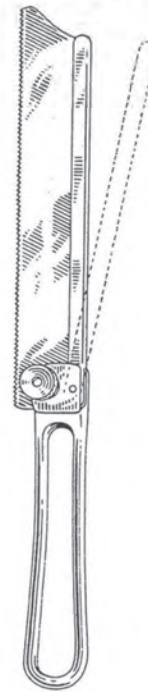

PC 14-3348-19  
 19 cm/7 1/2"

- EN —● Bone Plate Wrench and Screw and Plate Holding Forceps
- DE —● Knochenplatten-Biegehebel-schrauben und platten Haltezangen
- ES —● Elevador p/pleger las placas y pinzas porta-tornillos placas

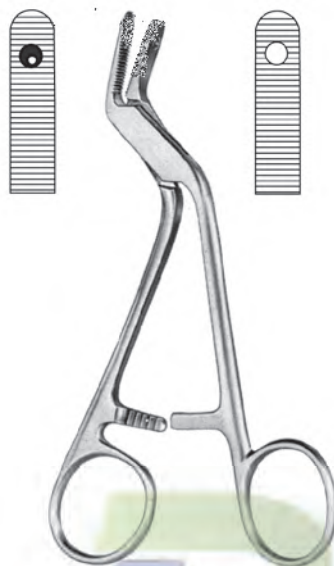

**ADSON**  
PC 14-3349-15  
15 cm/6"



**LANE**  
PC 14-3350-18  
18 cm/7"



**LANE**  
PC 14-3351-23  
23 cm/9"

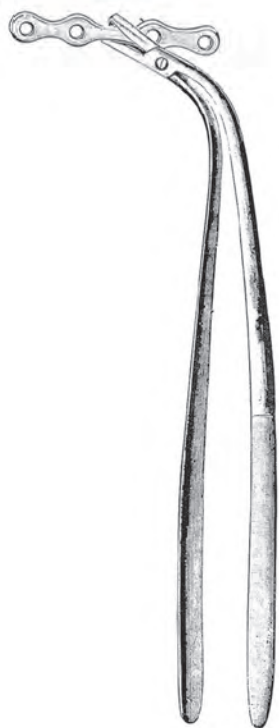

**LANE**  
PC 14-3352-23  
23 cm/9"



**LANE**  
PC 14-3353-18  
18 cm/7"



PC 14-3354-25  
25.5 cm/10"



Screw Drivers ●— EN  
 Schraubenzieher ●— DE  
 Destornilladores ●— ES



PC 14-3355-25  
25 cm/10"

**PHILLIPS**  
PC 14-3356-25  
25 cm/10"

**LANE**  
PC 14-3357-17 17 cm/6 3/4"  
PC 14-3358-25 25 cm/10"

**WILLIAMS**  
PC 14-3359-24 Flat  
PC 14-3360-24 Cross Slot  
24 cm/9 1/2"

EN —● Screw Drivers  
 DE —● Schraubenzieher  
 ES —● Destornilladores



### HEXAGONAL

PC 14-3361-25 2.5mm  
 PC 14-3362-25 3.5mm  
 PC 14-3363-25 4.5mm  
 25 cm/10"

### PHILLIPS

PC 14-3364-25  
 25 cm/10"

PC 14-3365-25  
 25 cm/10"

### LANE

PC 14-3366-17 17 cm/6 1/2"  
 PC 14-3367-25 25 cm/10"

Screw Driver set in case ●— EN  
 Schraubenzicher-set mit-Etui ●— DE  
 Juego de destornilladores en esuche ●— ES



PC 14-3368-14  
14.5 cm/5 1/2"

PC 14-3369-00

PC 14-3370-00 Screw driver set, complete in case  
 PC 14-3371-00 Sterilizing case only

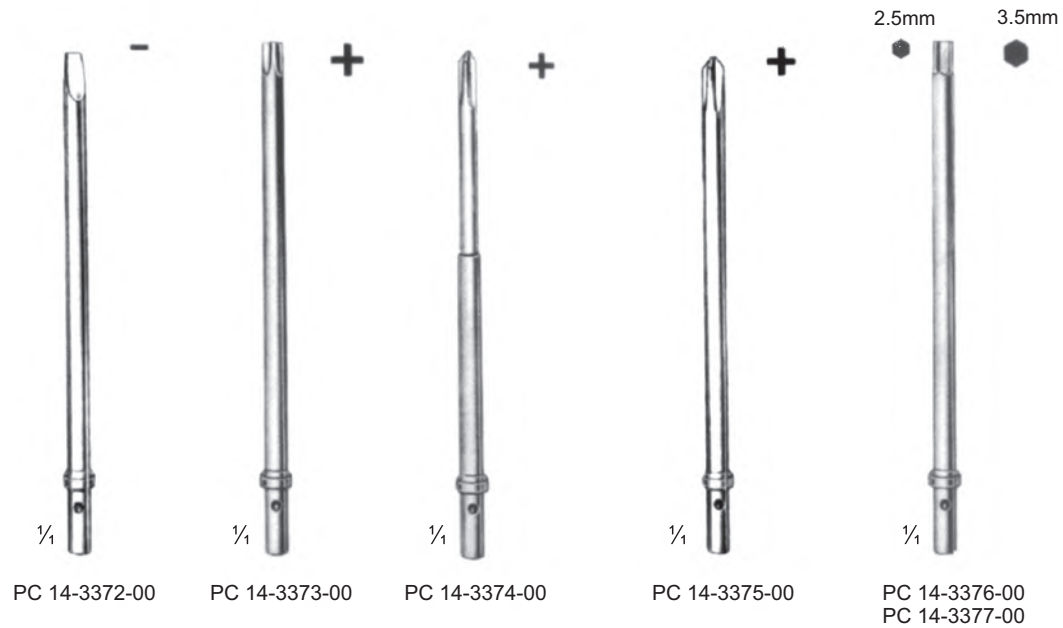

PC 14-3372-00

PC 14-3373-00

PC 14-3374-00

PC 14-3375-00

PC 14-3376-00  
 PC 14-3377-00

- EN —● Nail Driver and Reamers
- DE —● Nageln Sie Fahrer und Reibahlen
- ES —● Clave a conductores y escariadores



PC 14-3378-2  
2.4mm

PC 14-3379-3  
3.2mm

PC 14-3380-4  
4.8mm

PC 14-3381-6  
6.4mm



PC 14-3382-14  
14 cm/5 1/2"

PC 14-3383-14  
14 cm/5 1/2"

**PERTHES**  
PC 14-3384-21  
21 cm/8 1/2"

**TABB**  
PC 14-3385-02 2.4mm  
PC 14-3385-03 3.2mm  
PC 14-3385-04 4.8mm  
PC 14-3385-06 6.4mm



Flat Nose Pliers, Wire Cutting Pliers, Seizing Forceps ●— EN  
 Flachzangen, Draht-kheifzangen, Faßzangen ●— DE  
 Alicates planos, alicates para cortar alambre ●— ES



PC 14-3386-16  
16.5 cm/6 1/2"

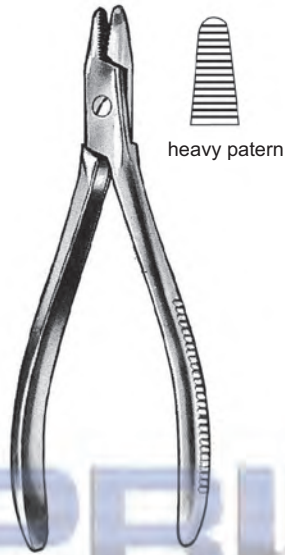

PC 14-3387-16  
16 cm/6 1/2"



PC 14-3388-15  
15 cm/6"



PC 14-3389-17  
17 cm/6 3/4"



PC 14-3390-18  
18 cm/7"



PC 14-3391-18  
18 cm/7"

- EN —● Flat Nose Pliers
- DE —● Flachzangen
- ES —● Alicates planos

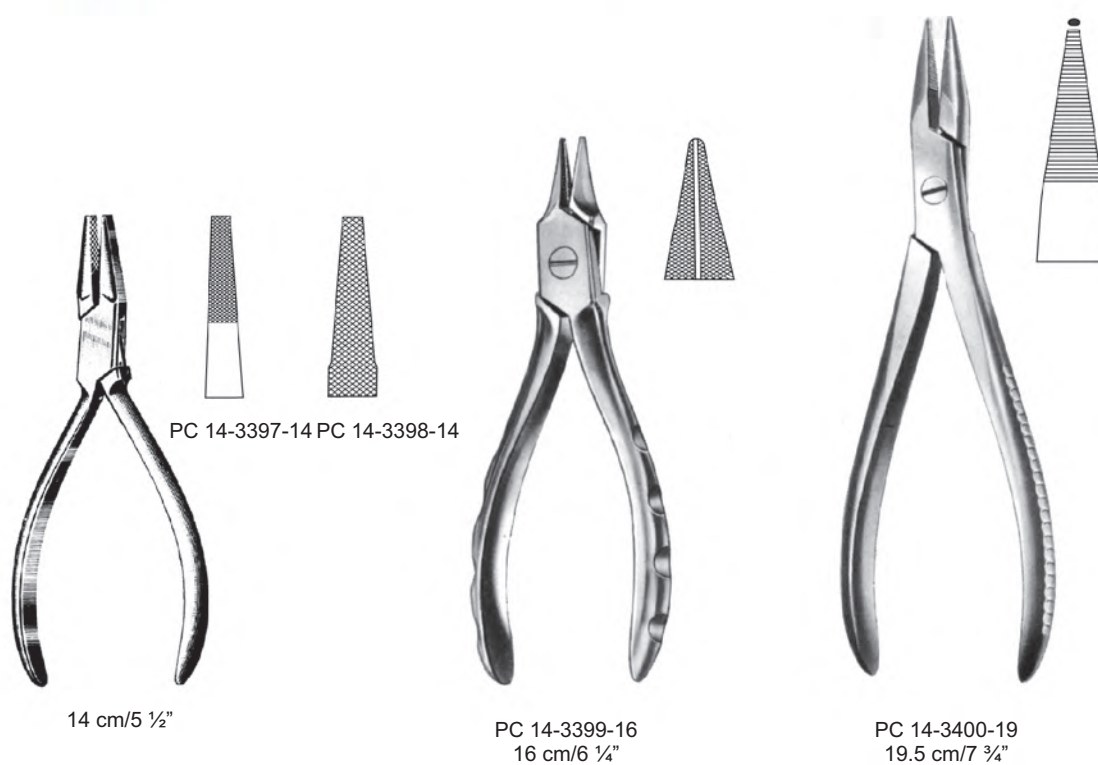

Impactor/Extractor, Wire Tighteners and Accessories ●— EN  
 drahtspanninstrumente und Zubehor ●— DE  
 Conductor-extractor, tensores cierra-hilo y accesorios ●— ES



**PARHAM**

PC 14-3401-18 18 cm/7"  
 PC 14-3401-20 20 cm/8"  
 PC 14-3401-25 25 cm/10"  
 PC 14-3401-30 30 cm/12"



**PARHAM**

PC 14-3402-22  
 22 cm/9 3/4"

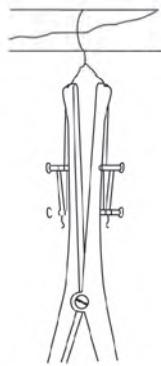

**DEMEL**

PC 14-3403-28  
 28 cm/11"



**LOUTE**

PC 14-3404-21  
 21 cm/8 1/4"



**LLOYD**

PC 14-3405-00

- EN —● Bone Wire, Bone Wire Guides
- DE —● Cerclage-Draht, Drahtumfuhrungsnadeln
- ES —● Hilo para huesos, agujas pasa-hilos



	soft	hard
0.2mm Ø	PC 14-3406-02	
0.3mm Ø	PC 14-3406-03	PC 14-3407-03
0.4mm Ø	PC 14-3406-04	PC 14-3407-04
0.5mm Ø	PC 14-3406-05	
0.6mm Ø	PC 14-3406-06	PC 14-3407-06
0.7mm Ø	PC 14-3406-07	
0.8mm Ø	PC 14-3406-08	PC 14-3407-08
0.9mm Ø	PC 14-3406-09	
1.0mm Ø	PC 14-3406-10	PC 14-3407-10
1.2mm Ø	PC 14-3406-12	
1.5mm Ø	PC 14-3406-15	

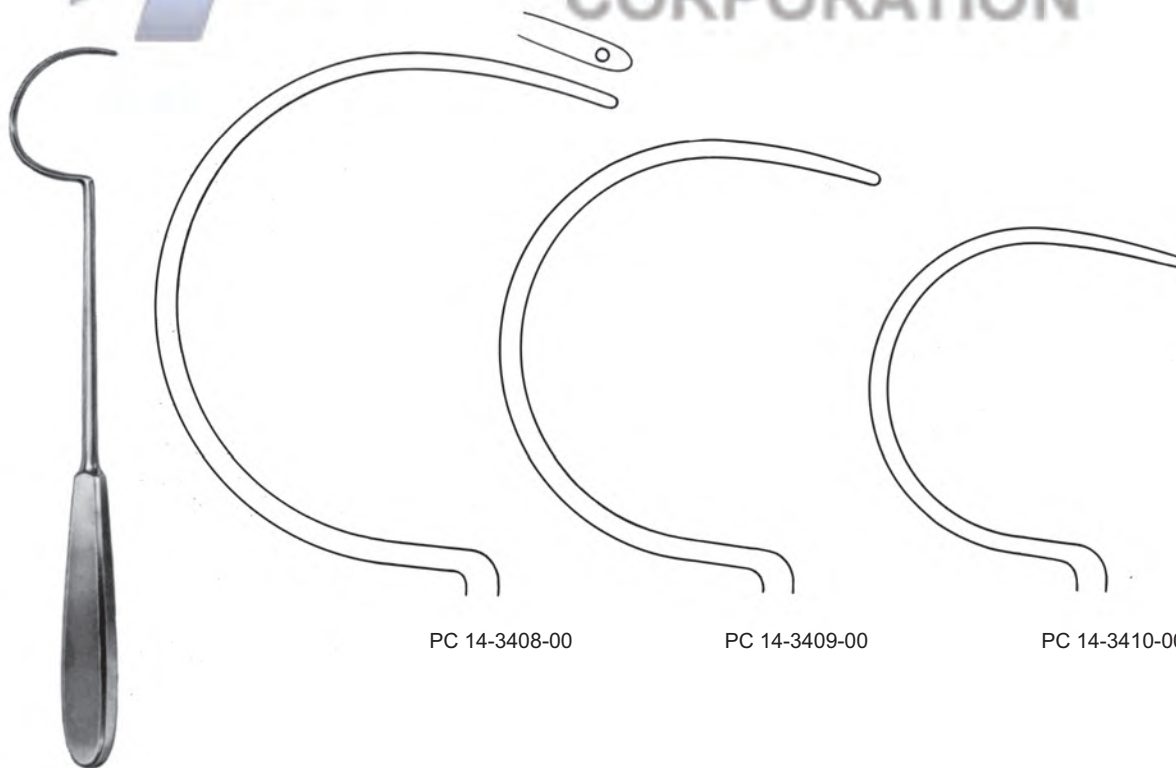

DEMEL

PC 14-3408-00

PC 14-3409-00

PC 14-3410-00



Bone Nailing ●— EN  
 Knochennagelung ●— DE  
 Enclavamiento de huesos ●— ES



**KUENTSCHER**  
 PC 14-3411-21  
 21 cm/8 ¼"

**KUENTSCHER**  
 PC 14-3412-21  
 21 cm/8 ¼"

**KUENTSCHER**  
 PC 14-3413-63  
 63 cm/26"  
 complete set

PC 14-3416-63 PC 14-3417-63

PC 14-3414-63 PC 14-3415-63

PC 14-3418-29 29 cm/11 ¾"  
 PC 14-3418-37 37 cm/15"  
 PC 14-3418-42 42 cm/16 ¾"  
 PC 14-3418-49 49 cm/19 ¾"  
 PC 14-3419-00

- EN —● Bone Nailing, Steinmann Pins
- DE —● Knochennagelung, Steinmann Nagel
- ES —● Enclavamiento de huesos, calvos segun steinmann

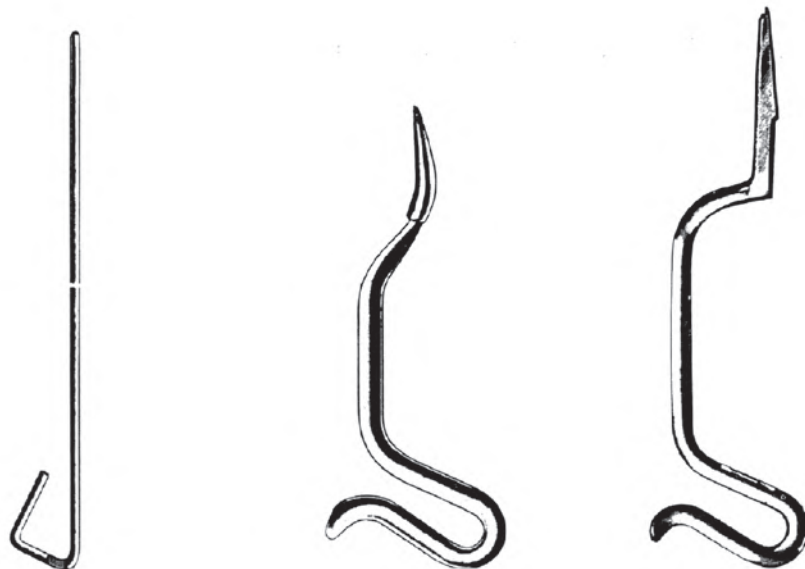

	L=35cm	L=46cm	L=60cm	<b>KUENTSCHER</b>	<b>KUENTSCHER</b>
2.5mm Ø	PC 14-3420-25	PC 14-3421-25		PC 14-3423-25	PC 14-3424-35
3.0mm Ø	PC 14-3420-30	PC 14-3421-30		25.5 cm/10"	35 cm/14"
3.5mm Ø	PC 14-3420-35	PC 14-3421-35	PC 14-3422-35		
4.0mm Ø	PC 14-3420-40	PC 14-3421-40	PC 14-3422-40		
5.0mm Ø	PC 14-3420-50	PC 14-3421-50	PC 14-3422-50		



**STEINMANN**  
4mm Ø (Trocar tip)  
PC 14-3425-14 140mm  
PC 14-3425-16 160mm  
PC 14-3425-18 180mm  
PC 14-3425-20 200mm



**SCHANZ**  
4mm Ø (Flat tip)  
PC 14-3426-06 60mm  
PC 14-3426-08 80mm  
PC 14-3426-10 100mm



**SCHANZ**  
6mm Ø (Flat tip)  
PC 14-3427-10 100mm  
PC 14-3427-13 130mm  
PC 14-3427-16 160mm  
PC 14-3427-19 190mm



**SCHANZ**  
5mm Ø (Trocar tip)  
PC 14-3428-10 100mm  
PC 14-3428-12 125mm  
PC 14-3428-15 150mm  
PC 14-3428-17 170mm  
PC 14-3428-20 200mm  
PC 14-3428-25 250mm

- Steinmann Pins ●— EN
- Steinmann Nagel ●— DE
- Calvos segun steinmann ●— ES

**KIRSCHNER**  
trocar point  
flat end

mm ø	60 mm	120mm	140mm	160mm	310mm
0.6	PC 14-3429-06				
0.8	PC 14-3429-08				
1.0	PC 14-3429-10	PC 14-3430-10	PC 14-3431-10	PC 14-3432-10	PC 14-3433-10
1.2	PC 14-3429-12	PC 14-3430-12	PC 14-3431-12	PC 14-3432-12	PC 14-3433-12
1.4	PC 14-3429-14	PC 14-3430-14	PC 14-3431-14	PC 14-3432-14	PC 14-3433-14
1.5	PC 14-3429-15	PC 14-3430-15	PC 14-3431-15	PC 14-3432-15	PC 14-3433-15
1.6	PC 14-3429-16	PC 14-3430-16	PC 14-3431-16	PC 14-3432-16	PC 14-3433-16
1.8	PC 14-3429-18	PC 14-3430-18	PC 14-3431-18	PC 14-3432-18	PC 14-3433-18
2.0	PC 14-3429-20	PC 14-3430-20	PC 14-3431-20	PC 14-3432-20	PC 14-3433-20
2.2	PC 14-3429-22	PC 14-3430-22	PC 14-3431-22	PC 14-3432-22	PC 14-3433-22
2.5	PC 14-3429-25	PC 14-3430-25	PC 14-3431-25	PC 14-3432-25	PC 14-3433-25

**KIRSCHNER**  
trocar point  
round end



mm ø	60 mm	120mm	140mm	160mm	310mm
1.0	PC 14-3434-10	PC 14-3435-10	PC 14-3436-10	PC 14-3437-10	PC 14-3438-10
1.2	PC 14-3434-12	PC 14-3435-12	PC 14-3436-12	PC 14-3437-12	PC 14-3438-12
1.4	PC 14-3434-14	PC 14-3435-14	PC 14-3436-14	PC 14-3437-14	PC 14-3438-14
1.5	PC 14-3434-15	PC 14-3435-15	PC 14-3436-15	PC 14-3437-15	PC 14-3438-15
1.6	PC 14-3434-16	PC 14-3435-16	PC 14-3436-16	PC 14-3437-16	PC 14-3438-16
1.8	PC 14-3434-18	PC 14-3435-18	PC 14-3436-18	PC 14-3437-18	PC 14-3438-18
2.0	PC 14-3434-20	PC 14-3435-20	PC 14-3436-20	PC 14-3437-20	PC 14-3438-20
2.2	PC 14-3434-22	PC 14-3435-22	PC 14-3436-22	PC 14-3437-22	PC 14-3438-22
2.5	PC 14-3434-25	PC 14-3435-25	PC 14-3436-25	PC 14-3437-25	PC 14-3438-25

**KIRSCHNER**  
lancet point  
flat end

mm ø	100 mm
1.0	PC 14-3439-10
1.2	PC 14-3439-12
1.5	PC 14-3439-15
1.6	PC 14-3439-16
1.8	PC 14-3439-18
2.0	PC 14-3439-20
2.2	PC 14-3439-22
2.5	PC 14-3439-25

- EN —● Extension Bows and Accessories
- DE —● Extensionsbügel und Zubehör
- ES —● Estribos para extension y accesorios

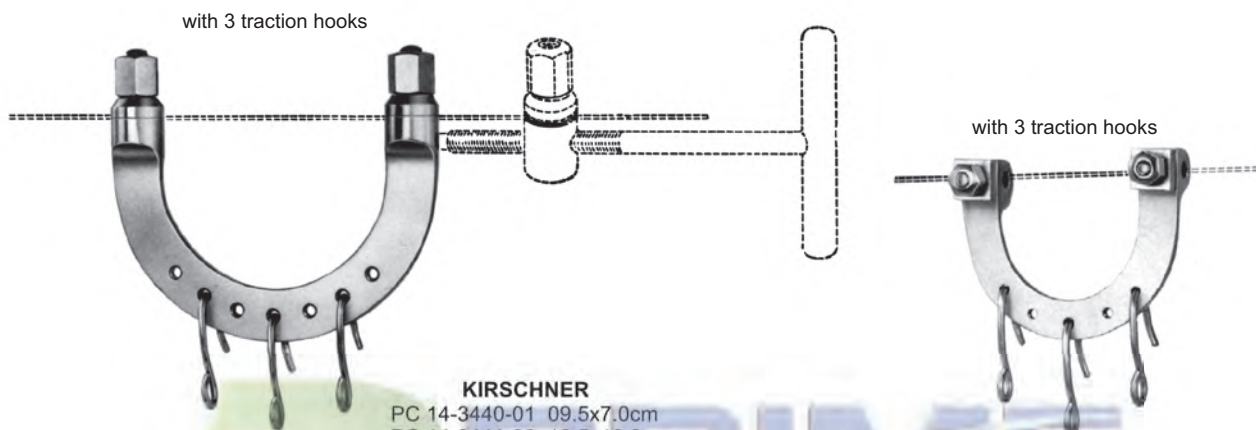

**KIRSCHNER**  
 PC 14-3440-01 09.5x7.0cm  
 PC 14-3441-02 10.5x10.0cm  
 PC 14-3442-03 12.0x12.0cm  
 PC 14-3443-04 15.5x15.5cm  
 PC 14-3444-05 20.0x15.5cm

**KIRSCHNER**  
 PC 14-3445-01  
 6.0x6.0cm



PC 14-3446-18 18.0x10.0cm  
 PC 14-3446-27 27.0x27.0cm



PC 14-3447-18



PC 14-3448-19  
 19.0cm



PC 14-3449-03    PC 14-3450-06



Extension Bows and Wire Cutting Pliers ●— EN  
 Extensionsbugel und Draht-Kneifzangen ●— DE  
 Estribos para extension y alicates para cortar alambre ●— ES

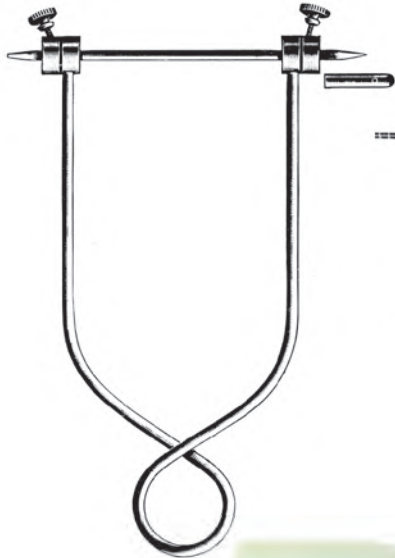

**BÖHLER**  
 PC 14-3451-15 21.0x15.0cm  
 PC 14-3451-16 16.0x 9.0cm  
 PC 14-3451-21 21.0x11.0cm



**KIRSCHNER**  
 PC 14-3452-13 13.5cm, infant  
 PC 14-3452-18 18.5cm, child  
 PC 14-3452-27 27.0cm, adult



**MARTIN-DIAMANT**  
 PC 14-3453-16  
 16 cm/6 1/4"



PC 14-3454-16  
 16 cm/6 1/4"



PC 14-3455-15  
 15 cm/6"



PC 14-3456-23  
 23 cm/9"



PC 14-3456-25  
 25 cm/10"



PC 14-3457-24  
 24 cm/9 1/4"

- EN —● Bone Curettes
- DE —● Scharfe Löffel
- ES —● Cucharillas cortantes

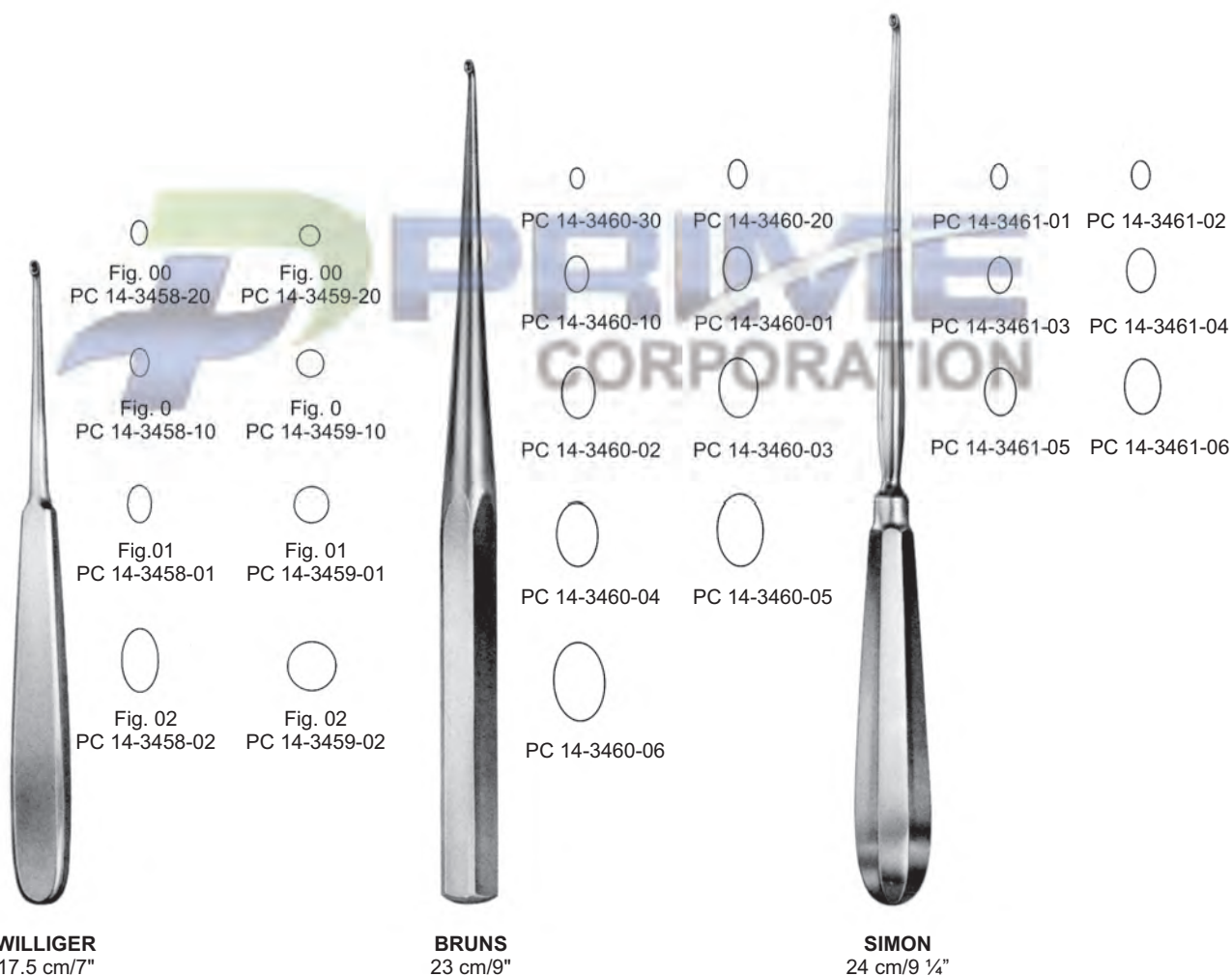

Bone Curettes ●— EN  
 Scharfe Löffel ●— DE  
 Cucharillas cortantes ●— ES



MOD. USA  
 16 cm/6 1/4"

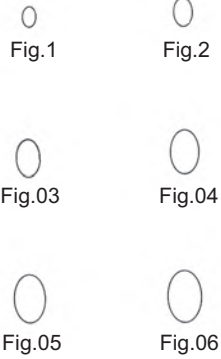

- |       |               |               |               |
|-------|---------------|---------------|---------------|
| Fig.1 | PC 14-3462-01 | PC 14-3463-01 | PC 14-3464-01 |
| Fig.2 | PC 14-3462-02 | PC 14-3463-02 | PC 14-3464-02 |
| Fig.3 | PC 14-3462-03 | PC 14-3463-03 | PC 14-3464-03 |
| Fig.4 | PC 14-3462-04 | PC 14-3463-04 | PC 14-3464-04 |
| Fig.5 | PC 14-3462-05 | PC 14-3463-05 | PC 14-3464-05 |
| Fig.6 | PC 14-3462-06 | PC 14-3463-06 | PC 14-3464-06 |



LEMPERT  
 17.5 cm/7"

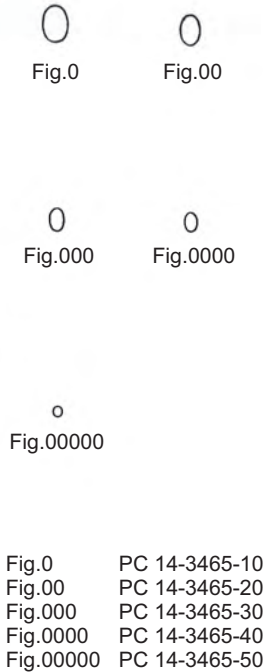

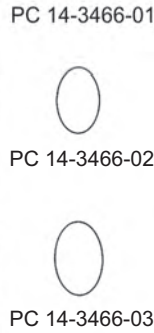

HALLE  
 21 cm/8 1/4"





25 cm/10"



- EN —● Bone Currettes
- DE —● Scharfe Löffel
- ES —● Cucharillas cortantes

 <p><b>VOLKMANN</b> 17 cm/7"</p>	0	0	0	 <p><b>BRUNS</b> 17 cm/7"</p>	0	0	0
	0000	000	00		0000	000	00
	PC 14-3468-40	PC 14-3468-30	PC 14-3468-20		PC 14-3469-40	PC 14-3469-30	PC 14-3469-20
	0	1	2		0	1	2
	PC 14-3468-10	PC 14-3468-01	PC 14-3468-02		PC 14-3469-10	PC 14-3469-01	PC 14-3469-02
	3	4			3	4	
	PC 14-3468-03	PC 14-3468-04		PC 14-3469-03	PC 14-3469-04		
	5	6		5	6		
	PC 14-3468-05	PC 14-3468-06		PC 14-3469-05	PC 14-3469-06		

 <p><b>SCHEDE</b> 17 cm/7"</p>	0	0	0	 <p><b>SPRATT</b> 16.5 cm/6 3/4"</p>	0	0	0
	000	00	0		0000	000	00
	PC 14-3470-30	PC 14-3470-20	PC 14-3470-10		PC 14-3471-40	PC 14-3471-30	PC 14-3471-20
	1	2			0		1
	PC 14-3470-01	PC 14-3470-02			PC 14-3471-10		PC 14-3471-01
	3	4			2		3
PC 14-3470-03	PC 14-3470-04		PC 14-3471-02		PC 14-3471-03		
			4		5		
			PC 14-3471-04		PC 14-3471-05		



Bone Curettes ●— EN  
 Scharfe Löffel ●— DE  
 Cucharillas cortantes ●— ES

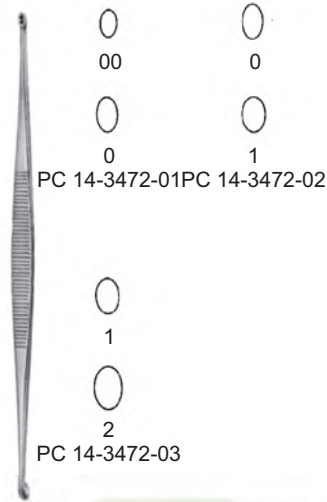

**WILLIGER**  
 13.5 cm/5 1/4"

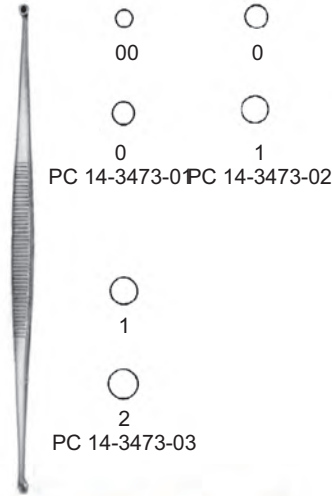

**MARTINI**  
 13.5 cm/5 1/4"



**VOLKMANN**  
 PC 14-3474-13 13 cm/5"  
 PC 14-3474-14 14 cm/5 1/2"  
 PC 14-3474-17 17 cm/7"



**VOLKMANN**  
 PC 14-3475-13 13 cm/5 1/4"  
 PC 14-3475-16 16 cm/6 1/4"  
 PC 14-3475-20 20 cm/8"



PC 14-3476-21  
 21 cm/8 1/4"



**VOLKMANN**  
 21.5 cm/8 1/2"

A  
 B  
 PC 14-3477-01

B  
 C  
 PC 14-3477-02

C  
 PC 14-3477-03

- EN —● Bone Curettes
- DE —● Scharfe Löffel
- ES —● Cucharillas cortantes

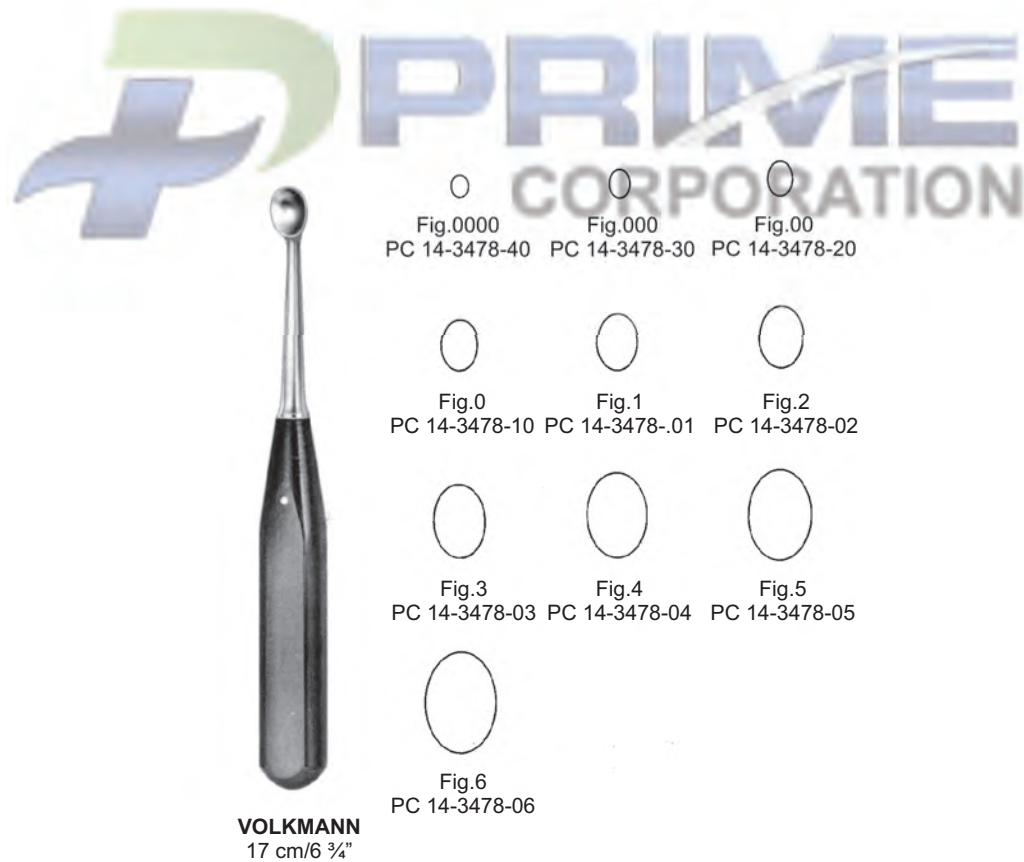

- Bone Currettes ●— EN
- Scharfe Löffel ●— DE
- Cucharillas cortantes ●— ES

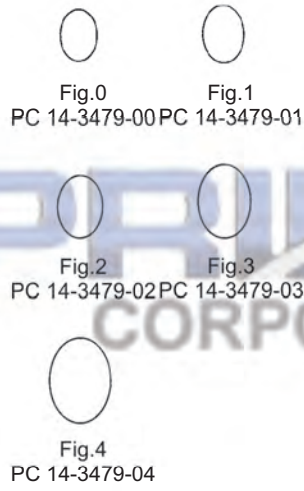

**VOLKMANN**  
27 cm/10 3/4"

- EN —● Bone Holding Forceps
- DE —● Knochenhaltezaugen
- ES —● Pinzas para huesos





Bone Holding Forceps ● EN  
 Knochenhaltezangen ● DE  
 Pinzas para huesos ● ES



- EN —● Bone Holding Forceps
- DE —● Knochenhaltezangen
- ES —● Pinzas para huesos



**Semb**  
PC 14-3495-19  
19 cm/7½"



**Semb**  
PC 14-3496-19  
19 cm/7½"



**Verbrugge**  
PC 14-3497-17  
17.5 cm/7"



**Verbrugge**  
PC 14-3498-17  
17.5 cm/7"



PC 14-3499-25  
25 cm/10"

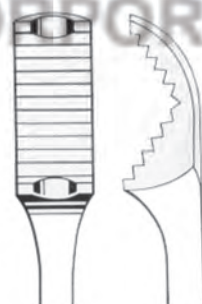
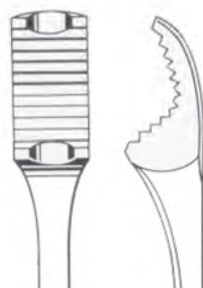

PC 14-3499-26  
26 cm/10¼"  
**Vebrugge**



PC 14-3499-27  
27 cm/10½"

Bone Holding Forceps ● EN  
 Knochenhaltezangen ● DE  
 Pinzas para huesos ● ES



PC 14-3501-16  
 16 cm/6¼"  
 PC 14-3501-24  
 24 cm/9½"



Without Ratchet  
 PC 14-3502-17  
 PC 14-3502-21

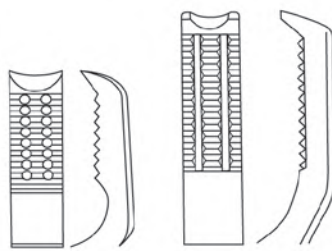

**Kern**

cm	in
17	6¾"
21	8¼"

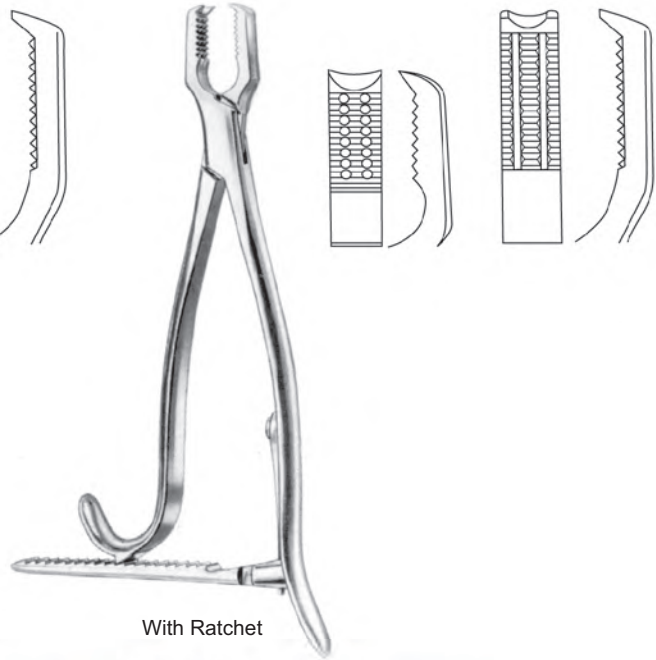

With Ratchet  
 PC 14-3503-17  
 PC 14-3503-21

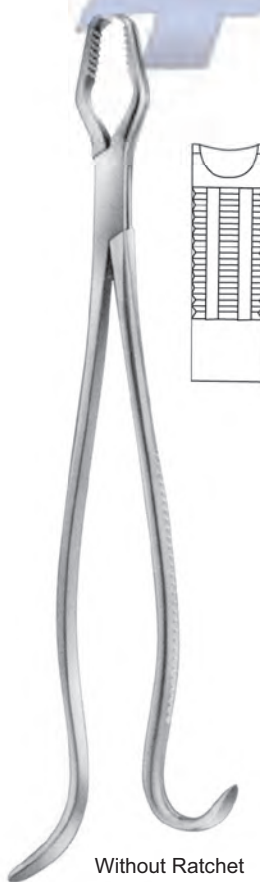

Without Ratchet  
 PC 14-3504-33  
 PC 14-3504-45

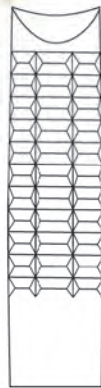

**Lane**

cm	in
33	13"
45	17¾"

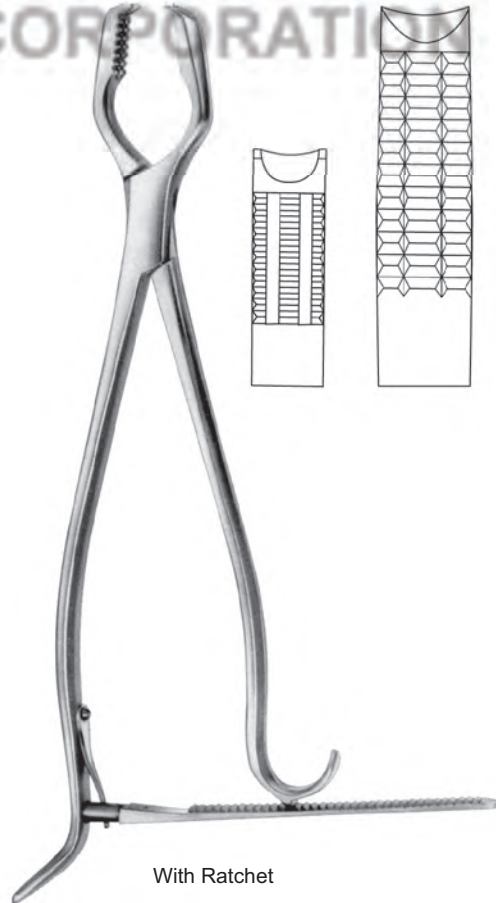

With Ratchet  
 PC 14-3505-33  
 PC 14-3505-45

- EN —● Bone Holding Forceps
- DE —● Knochenhaltezangen
- ES —● Pinzas para huesos





- Bone Holding Forceps ● EN
- Knochenhaltezaugen ● DE
- Pinzas para huesos ● ES



PC 14-3508-19 19 cm/8 3/4"  
PC 14-3508-26 26 cm/10 1/4"

**ULRICH**  
PC 14-3508-28  
28 cm/11"

- EN —● Bone Holding Forceps
- DE —● Knochenhaltezangen
- ES —● Pinzas para huesos



**Farabeuf-Lambotte**  
PC 14-3509-26  
26 cm/10¼"

**Lambotte**  
PC 14-3510-19 19 cm/7½"  
PC 14-3510-23 23 cm/9"  
PC 14-3510-26 26 cm/10¼"

PC 14-3511-13  
13.5 cm/5 ¼"

**Bruns**  
PC 14-3511-18  
18.5 cm/7 ¼"

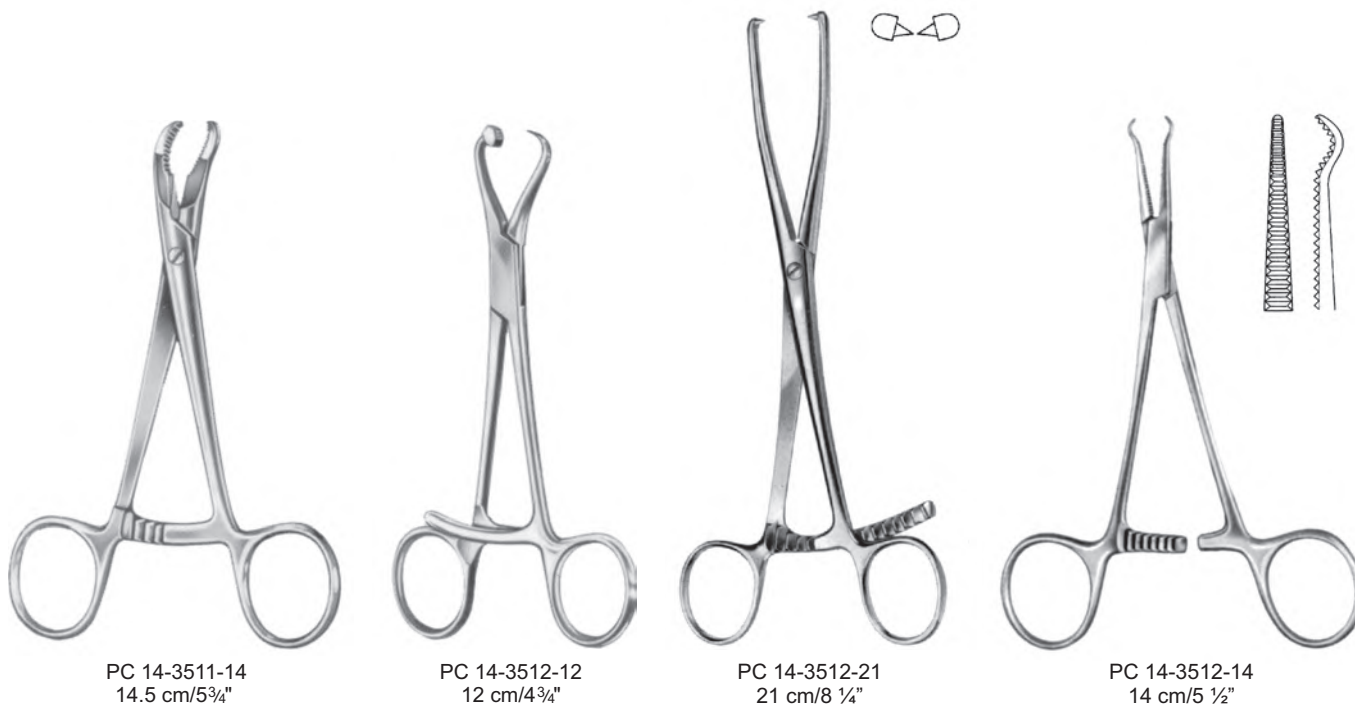

PC 14-3511-14  
14.5 cm/5¾"

PC 14-3512-12  
12 cm/4¾"

PC 14-3512-21  
21 cm/8 ¼"

PC 14-3512-14  
14 cm/5 ½"

Bone Holding Forceps ● EN  
 Knochenhaltezangen ● DE  
 Pinzas para huesos ● ES



PC 14-3513-15 15 cm/6"  
 PC 14-3513-19 19 cm/7½"  
 PC 14-3513-24 24 cm/9½"  
 PC 14-3513-26 26 cm/10¼"  
 PC 14-3513-28 28 cm/11"

Handles Detachable

**Percy**  
PC 14-3514-30

**Percy**  
PC 14-3514-00



Adjustable

**Lambotte**  
 PC 14-3515-22 22 cm/8¾"  
 PC 14-3515-27 27 cm/10½"  
 PC 14-3515-30 30 cm/12"

**Farabeuf**  
 PC 14-3516-23 23 cm/9"  
 PC 14-3516-26 26 cm/10¼"

**Lambotte**  
 PC 14-3517-22 22.5 cm/9"  
 PC 14-3517-25 25.5 cm/10½"  
 PC 14-3517-33 33 cm/13½"

**Haase**  
 PC 14-3517-16  
 16.5 cm/6 ½"

- EN —● Bone Holding Forceps  
 DE —● Knochenhaltezangen  
 ES —● Pinzas para huesos



PC 14-3518-19  
19 cm/7 3/4"



PC 14-3519-23  
23 cm/9"



PC 14-3520-25  
25 cm/10"



Bone Holding Forceps    ● — EN  
 Knochenhaltezangen    ● — DE  
 Pinzas para huesos    ● — ES



**FROSCH**  
 PC 14-3521-18  
 18 cm/7"



PC 14-3522-20  
 20 cm/8"



PC 14-3523-18  
 18.5 cm/7 1/2"



PC 14-3524-40  
 40 cm/16"



PC 14-3525-40  
 40 cm/16"

- EN —● Bone Holding Forceps  
 DE —● Knochenhaltezangen  
 ES —● Pinzas para huesos



**TUFFIER**  
 PC 14-3526-27  
 27 cm/10 3/4"



PC 14-3527-19 19 cm/7 3/4"  
 PC 14-3527-26 26 cm/10 1/4"

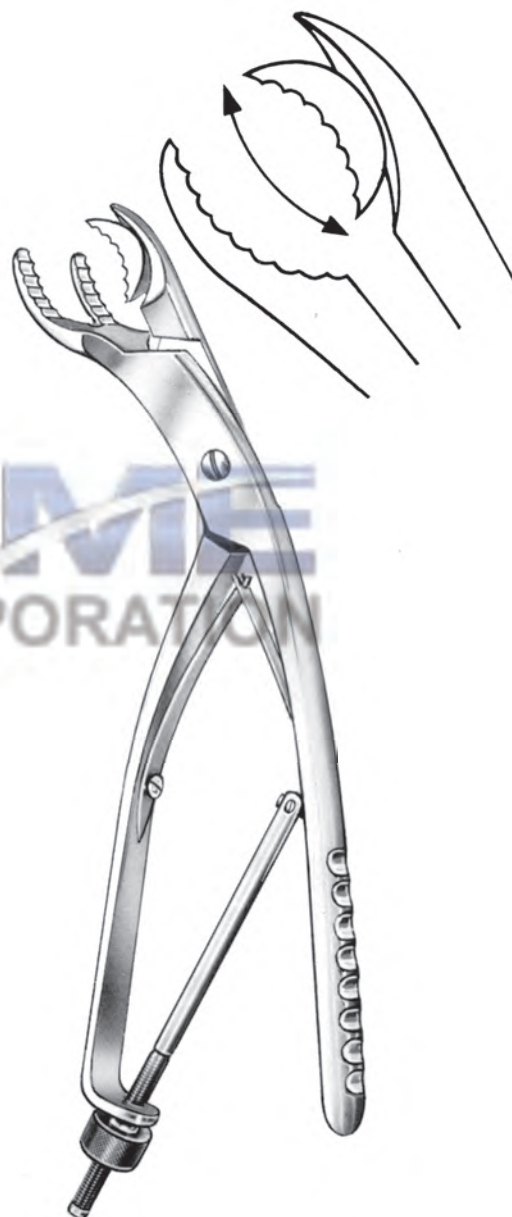

**ULRICH**  
 PC 14-3528-28  
 28 cm/11"

- Bone Holding Forceps ● EN
- Knochenhaltezaugen ● DE
- Pinzas para huesos ● ES



PC 14-3529-13  
13.5 cm/5¼"

PC 14-3530-20  
20 cm/8"

- EN —● Bone Holding Forceps  
 DE —● Knochenhaltezaugen  
 ES —● Pinzas para huesos



**Reall**  
 PC 14-3531-17  
 17 cm/6¾"



Patella Forceps

PC 14-3532-17  
 17.5 cm/7"



Bone Holding Forceps ● EN  
 Knochenhaltezangen ● DE  
 Pinzas para huesos ● ES



LOWMAN		GERSTER-LOWMANN		LAMBERT-LOWMAN		LOWMAN-HOGLUND	
PC 14-3533-12	12.0cm	PC 14-3534-18	18.0cm	2x2 prongs		PC 14-3536-12	12.0cm
PC 14-3533-18	18.5cm	PC 14-3534-20	20.0cm	PC 14-3535-18	18.0cm	PC 14-3536-17	17.5cm
PC 14-3533-20	20.0cm	PC 14-3534-22	22.0cm	PC 14-3535-20	20.0cm	PC 14-3536-20	20.0cm
PC 14-3533-22	22.0cm			PC 14-3535-22	22.0cm	PC 14-3536-22	22.0cm

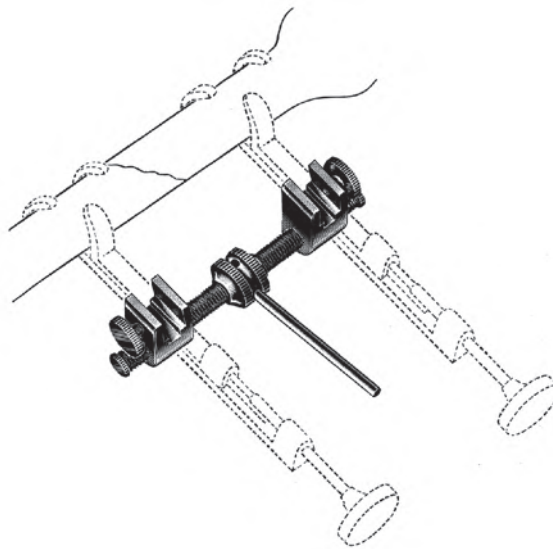

**GERSTER**  
 PC 14-3537-15

- EN —● Bone Rongeur Forceps
- DE —● Hohlmeißelzangen
- ES —● Pinzas-gubias



PC 14-3538-01 PC 14-3538-02

13 cm/5 1/4"



PC 14-3539-01 PC 14-3539-02

13 cm/5 1/4"

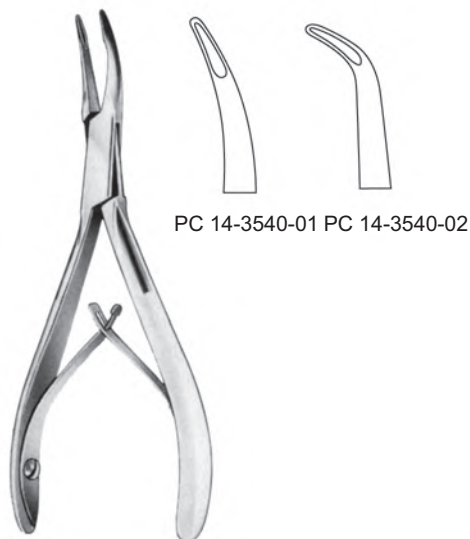

PC 14-3540-01 PC 14-3540-02

**KLEINERT-KUTZ**  
14 cm/5 1/2"

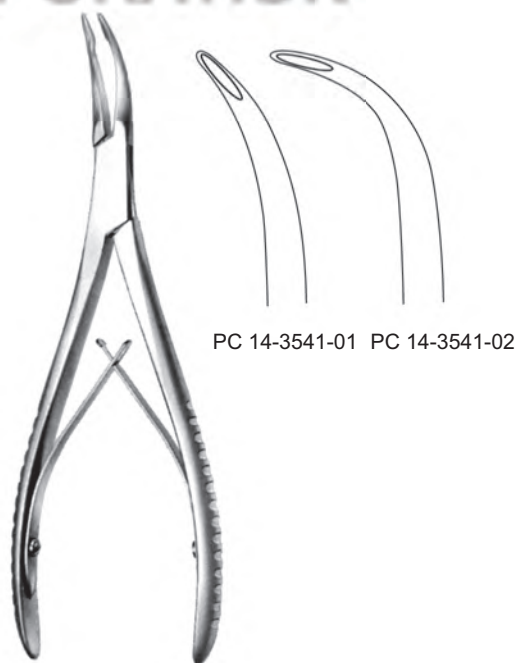

PC 14-3541-01 PC 14-3541-02

**STELLBRINK**  
17 cm/6 3/4"

- Bone Rongeur Forceps ● EN
- Hohlmeißelzangen ● DE
- Pinzas-gubias ● ES



**MINI-FRIEDMAN**  
PC 14-3543-12  
12 cm/4 ¾"



**FRIEDMAN**  
PC 14-3544-14  
14 cm/5 ½"



**MEAD**  
PC 14-3545-16  
16.5 cm/6 ½"



**MEAD**  
PC 14-3546-16  
16.5 cm/6 ½"



**HARTMANN**  
PC 14-3547-16  
16 cm/6 ¼"



**HARTMANN**  
PC 14-3548-18  
18.5 cm/7 ¼"

- EN —● Bone Rongeur Forceps
- DE —● Hohlmeißelzangen
- ES —● Pinzas-gubias



**JANSEN**  
18 cm/7"



PC 14-3552-01



PC 14-3552-02



PC 14-3552-03



**BLUMENTHAL**  
15 cm/6"



PC 14-3553-01



PC 14-3553-02



PC 14-3553-03



**LEMPERT**  
20 cm/8"



PC 14-3554-20



PC 14-3555-20



**DEFOURMENTEL**  
PC 14-3556-19  
19 cm/7 3/4"





Bone Rongeur Forceps ● EN  
 Hohlmeißelzangen ● DE  
 Pinzas-gubias ● ES



**BANE**  
 PC 14-3557-18  
 18 cm/7"



**ADSON**  
 PC 14-3558-21  
 21 cm/8 ¼"



**BACON**  
 PC 14-3559-20  
 20 cm/8"



**FISCH**  
 17 cm/6 ¾"



PC 14-3560-01



PC 14-3560-02



- EN —● Bone Rongeur Forceps
- DE —● Hohlmeißelzangen
- ES —● Pinzas-gubias



**LUER**  
PC 14-3561-01  
15 cm/6"



**LUER**  
PC 14-3561-02  
15 cm/6"



**LUER**  
PC 14-3561-03  
15 cm/6"



**LUER**  
PC 14-3562-01  
15 cm/6"



**LUER**  
PC 14-3562-02  
15 cm/6"

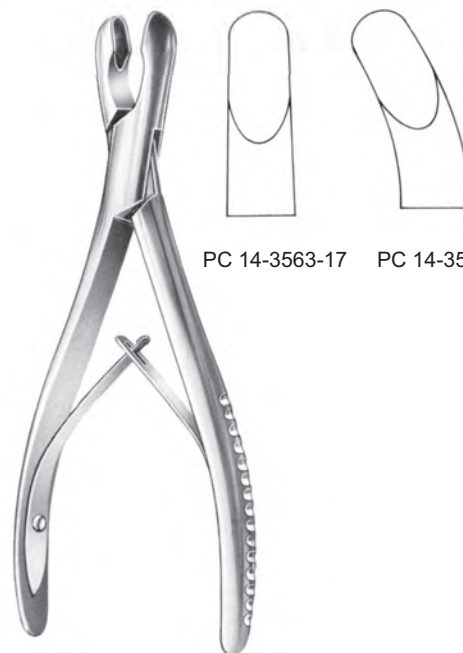

PC 14-3563-17    PC 14-3564-17

**LUER**  
17 cm/6 3/4"

- Bone Rongeur Forceps ● EN
- Hohlmeißelzangen ● DE
- Pinzas-ubias ● ES

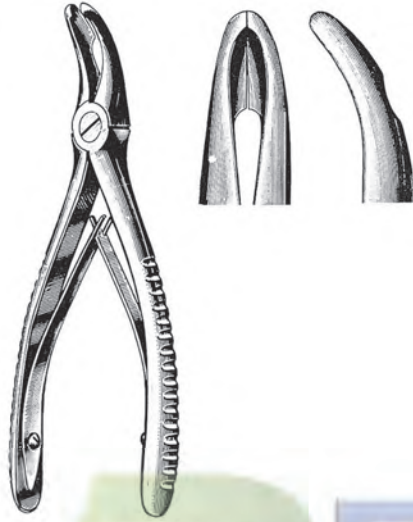

**UNIVERSAL**  
PC 14-3565-13  
13.5 cm/5 ¼"

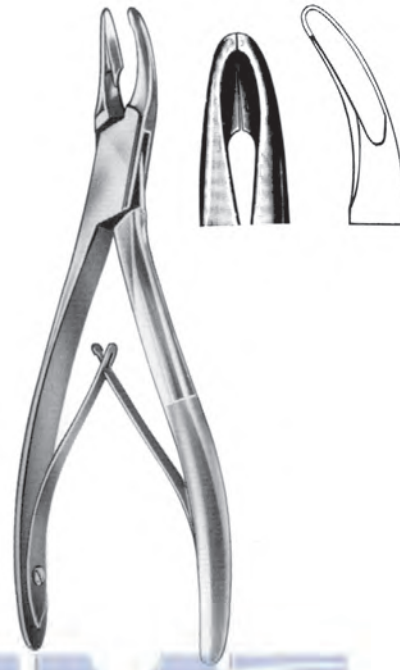

**SHELL**  
PC 14-3566-17  
17 cm/6 ¾"



**COTTLE-JANSEN**  
PC 14-3567-18  
18 cm/7"



**JANSEN**  
PC 14-3568-19  
19 cm/7 ½"

- EN —● Bone Rongeur Forceps  
 DE —● Hohlmeißelzangen  
 ES —● Pinzas-gubias



**SMITH-PETERSEN**  
 PC 14-3569-01  
 24 cm/9 ½"



**SMITH-PETERSEN**  
 PC 14-3569-02  
 24 cm/9 ½"



**SMITH-PETERSEN**  
 PC 14-3569-03  
 24 cm/9 ½"



- Bone Rongeur Forceps ● EN
- Hohlmeißelzangen ● DE
- Pinzas-gubias ● ES

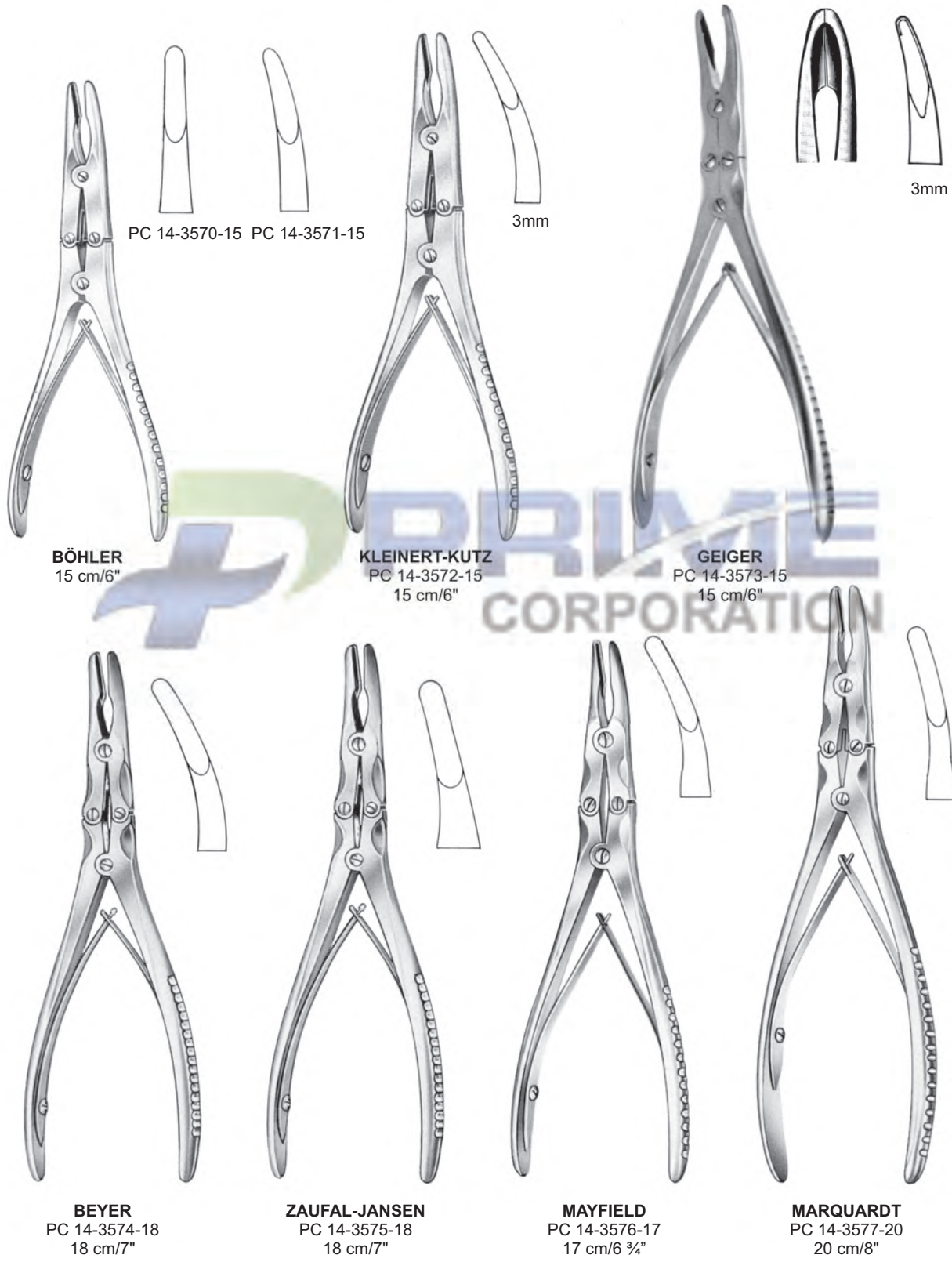

**BÖHLER**  
15 cm/6"

**KLEINERT-KUTZ**  
PC 14-3572-15  
15 cm/6"

**GEIGER**  
PC 14-3573-15  
15 cm/6"

**BEYER**  
PC 14-3574-18  
18 cm/7"

**ZAUFAL-JANSEN**  
PC 14-3575-18  
18 cm/7"

**MAYFIELD**  
PC 14-3576-17  
17 cm/6 3/4"

**MARQUARDT**  
PC 14-3577-20  
20 cm/8"

- EN —● Bone Rongeur Forceps
- DE —● Hohlmeißelzangen
- ES —● Pinzas-gubias

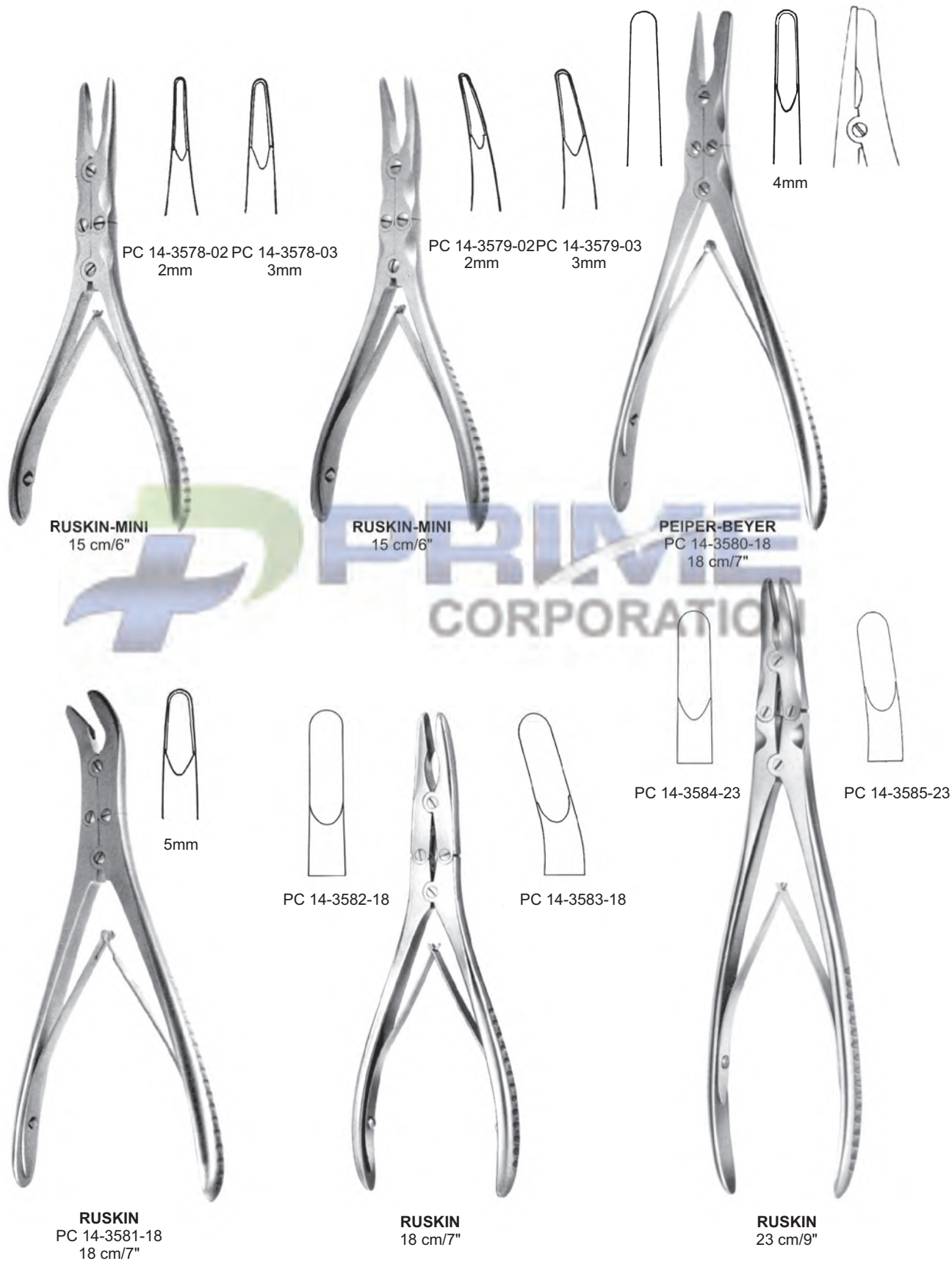

- Bone Rongeur Forceps ● EN
- Hohlmeißelzangen ● DE
- Pinzas-gubias ● ES

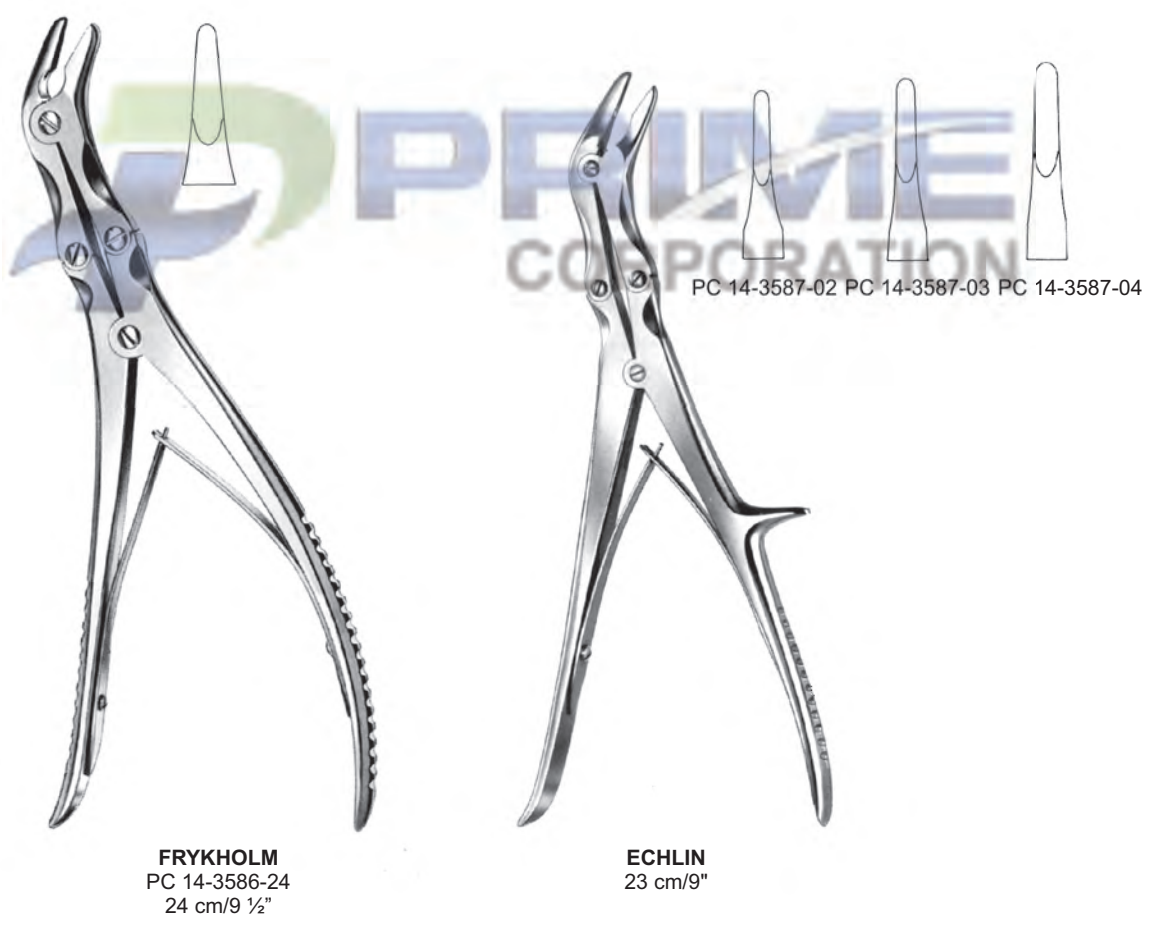

**FRYKHOLM**  
PC 14-3586-24  
24 cm/9 1/2"

**ECHLIN**  
23 cm/9"

- EN —● Bone Rongeur Forceps
- DE —● Hohlmeißelzangen
- ES —● Pinzas-gubias



5mm

**STILLE-LEKSELL**  
PC 14-3588-23  
23 cm/9"



PC 14-3589-05  
5mm

PC 14-3589-08  
8mm

**LEKSELL**  
23 cm/9"



PC 14-3590-08  
8 mm

PC 14-3590-04  
4 mm

**LEKSELL-STILLE**  
24 cm/9 1/4"



- Bone Rongeur Forceps ● EN
- Hohlmeißelzangen ● DE
- Pinzas-gubias ● ES



**STILLE**  
PC 14-3591-23  
23 cm/9"

**STILLE-RUSKIN**  
PC 14-3592-01 23 cm/9" PC 14-3592-02

**SEMB**  
PC 14-3593-22  
22.5 cm/9"

- EN —● Bone Rongeur Forceps  
 DE —● Hohlmeißelzangen  
 ES —● Pinzas-gubias

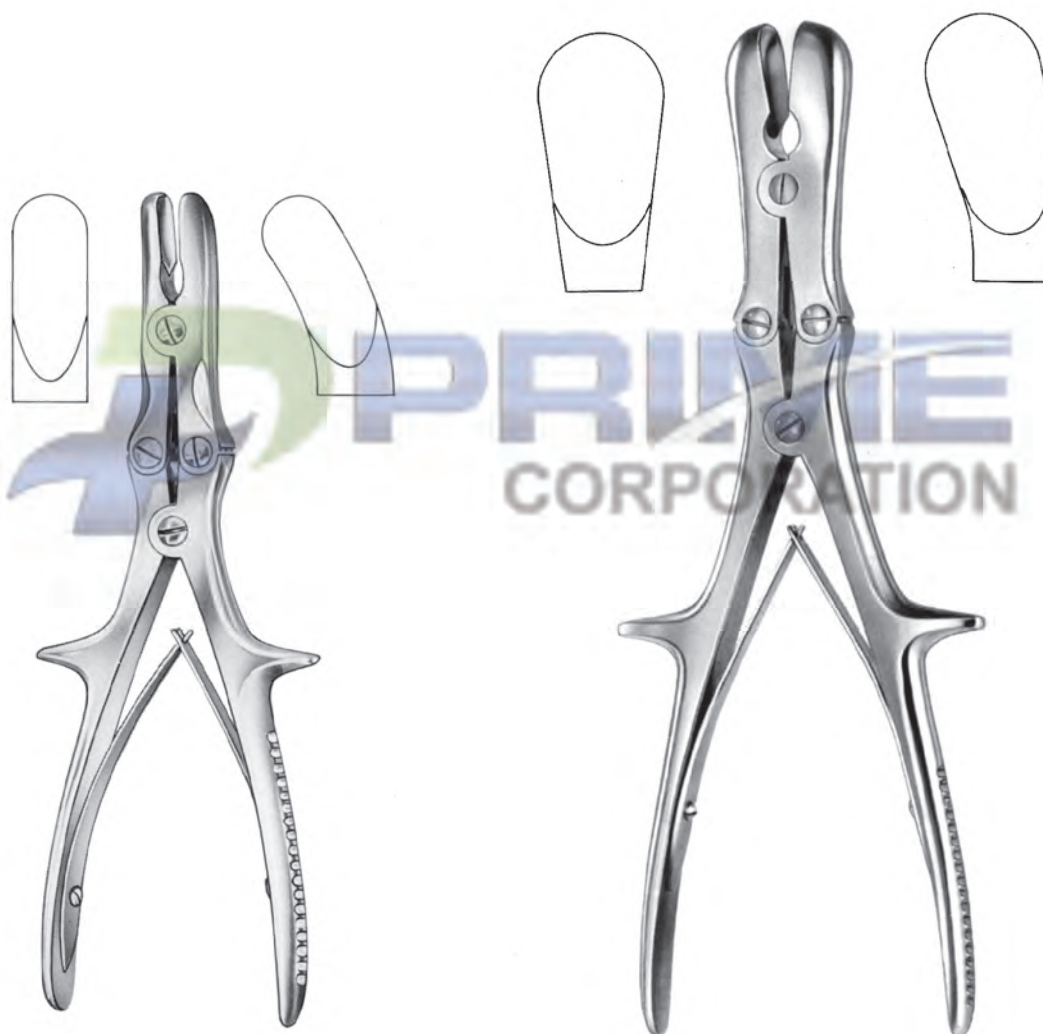

**STILLE-LUER**  
 PC 14-3594-01 22 cm/8 3/4" PC 14-3594-02

**STILLE-LUER**  
 PC 14-3595-23 23 cm/9" PC 14-3596-23  
 PC 14-3595-27 27 cm/10 3/4" PC 14-3596-27

- Bone Rongeur Forceps ● EN
- Hohlmeißelzangen ● DE
- Pinzas-gubias ● ES

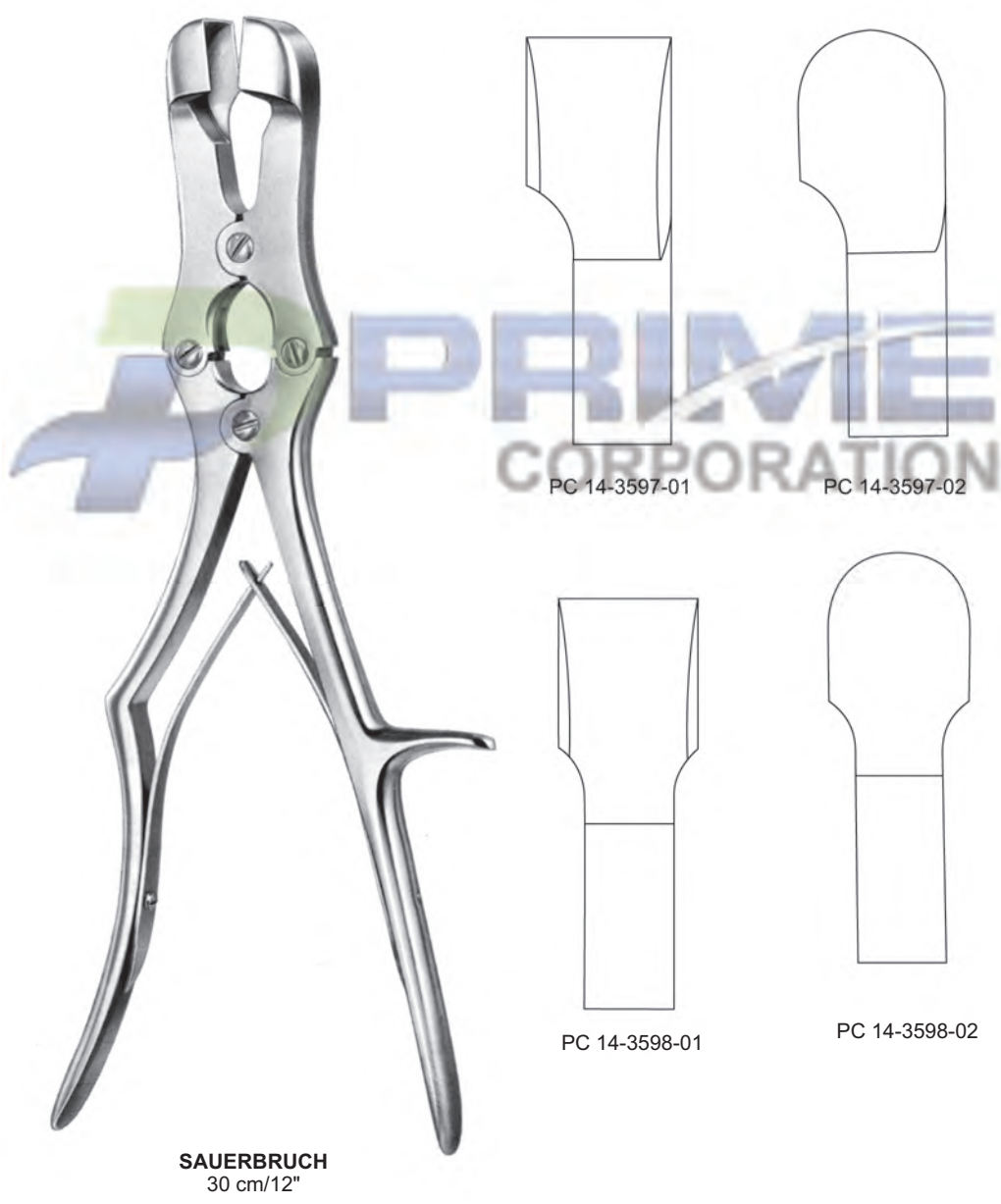

**SAUERBRUCH**  
30 cm/12"

- EN —● Bone Cutting Forceps
- DE —● Knochensplitterzangen
- ES —● Pinzas cortantes para huesos

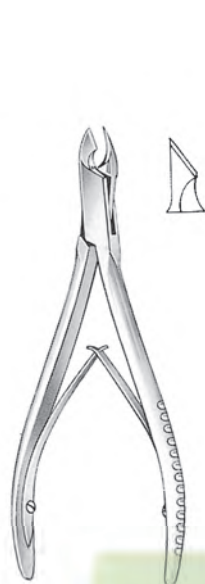

PC 14-3599-12  
12 cm/5"

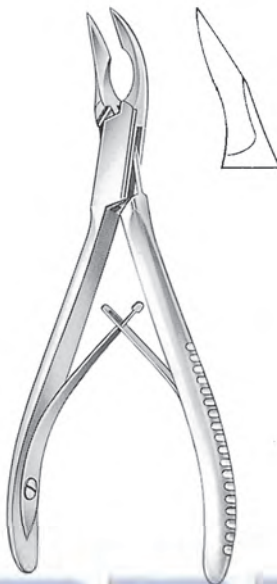

CLEVELAND  
PC 14-3600-15  
15 cm/6"

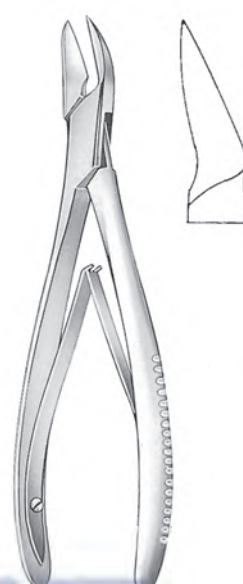

CLEVELAND  
PC 14-3601-17  
17 cm/6 3/4"

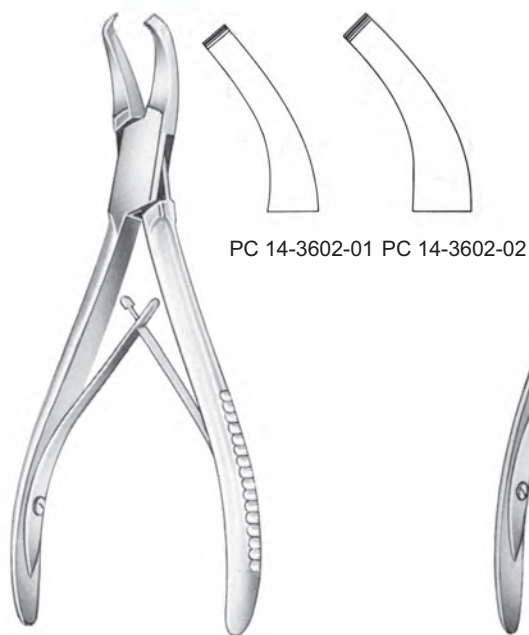

CLEVELAND  
16 cm/6 1/2"

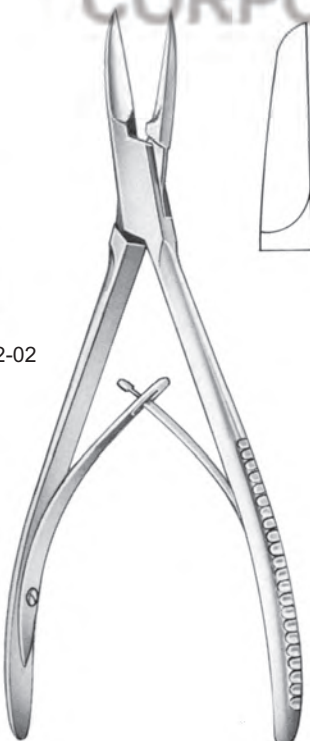

COTTLE-KAZANJIAN  
PC 14-3603-19  
19 cm/7 3/4"



MARKWALDER  
PC 14-3604-20  
20 cm/8"



Bone Cutting Forceps ● EN  
 Knochensplitterzangen ● DE  
 Pinzas cortantes para huesos ● ES

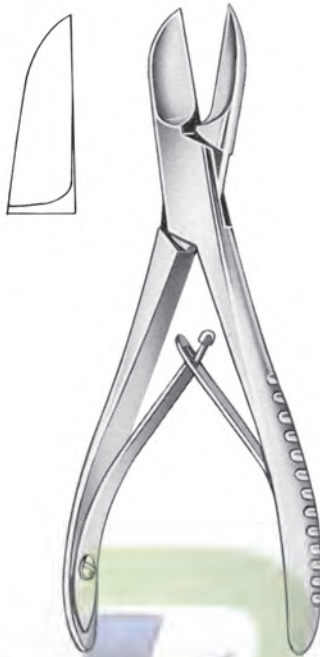

**LISTON**  
 PC 14-3605-14 14.0cm PC 14-3606-14  
 PC 14-3605-17 17.0cm PC 14-3606-17  
 PC 14-3605-19 19.0cm PC 14-3606-19  
 PC 14-3605-22 22.0cm PC 14-3606-22



**MC INDOE**  
 PC 14-3607-17  
 17.5 cm/7"



**Bouier**  
 PC 14-3608-15  
 15 cm/6"

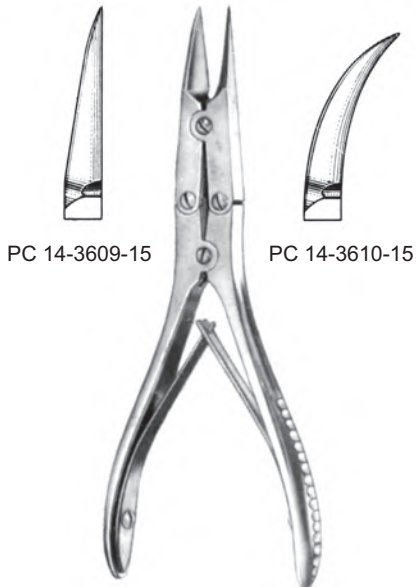

PC 14-3609-15      PC 14-3610-15

15 cm/6"

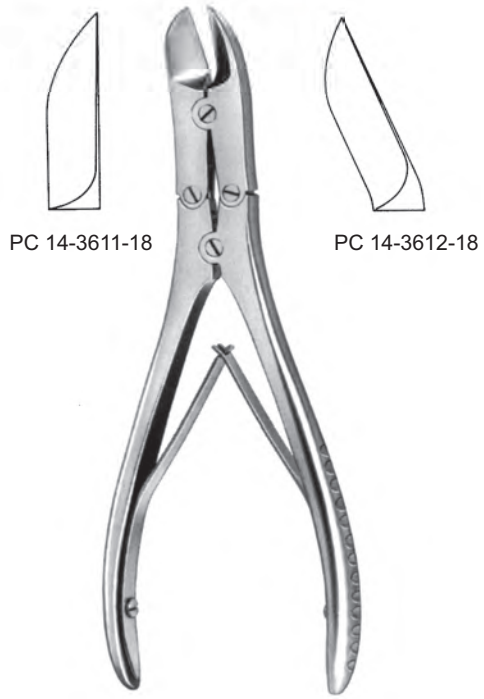

**RUSKIN-LISTON**  
 18.5 cm/7 1/2"

- EN —● Bone Cutting Forceps  
 DE —● Knochensplitterzangen  
 ES —● Pinzas cortantes para huesos

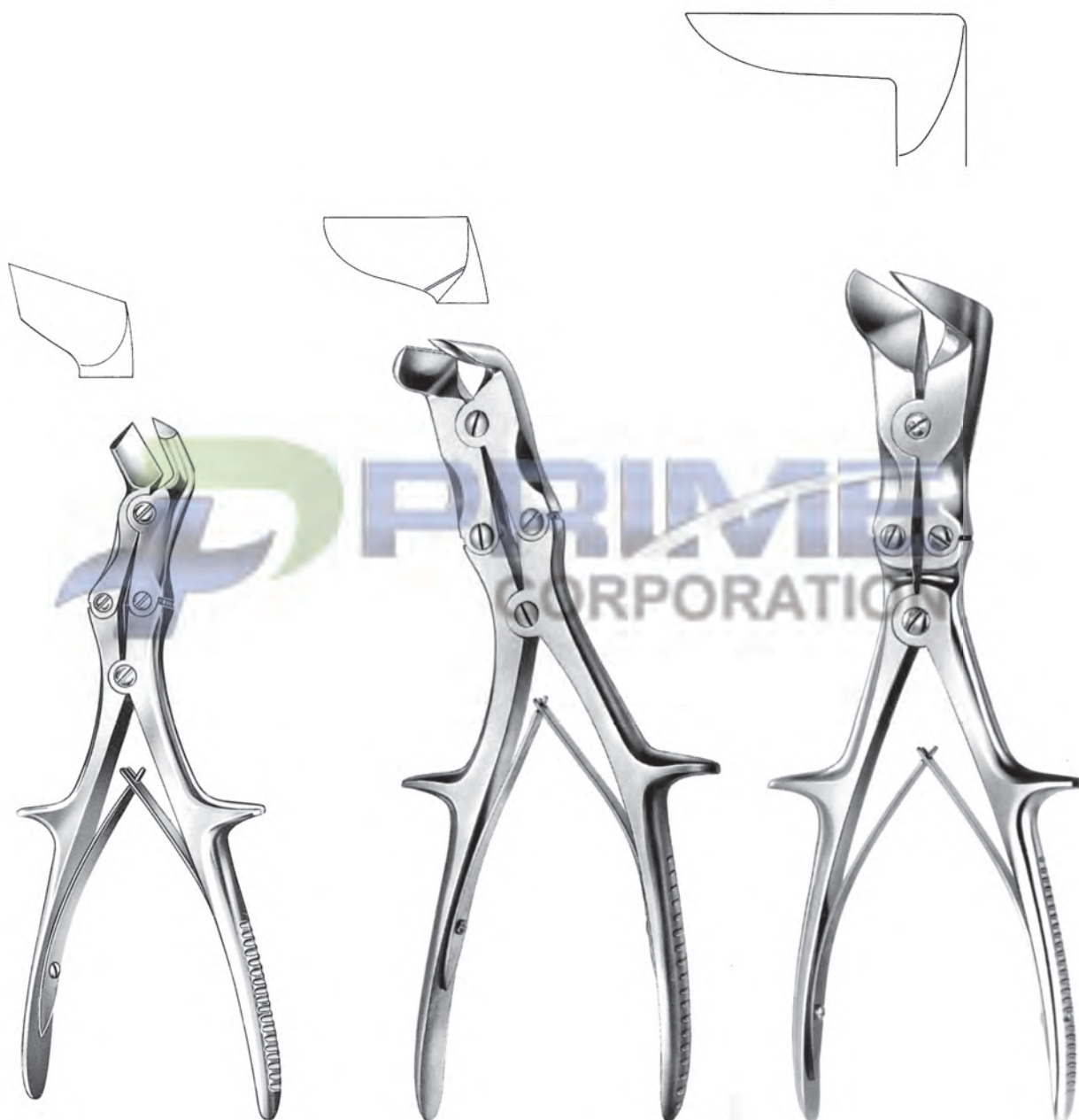

**TUDOR-EDWARDS**  
 PC 14-3613-23  
 23 cm/9"

**SEMB**  
 PC 14-3614-24  
 24 cm/9 3/4"

**STILLE-LISTON**  
 PC 14-3615-27  
 27 cm/10 3/4"

Bone Cutting Forceps ● EN  
 Knochensplitterzangen ● DE  
 Pinzas cortantes para huesos ● ES

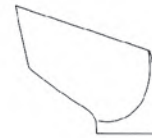
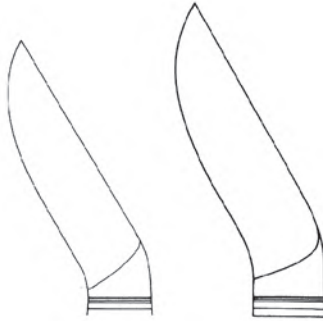

PC 14-3617-23 PC 14-3617-27



**STILLE LISTON**  
 PC 14-3616-27  
 27 cm/10 3/4"



**STILLE LISTON**  
 PC 14-3617-23 23 cm/9"  
 PC 14-3617-27 27 cm/10 3/4"



**LISTON KEY**  
 PC 14-3618-27  
 27 cm/10 3/4"

- EN —● Nail Instruments, Finger Ring Saws
- DE —● Instrumente für Finger-und Zehennägel
- ES —● Instrumentos para uñas, Sierras para abrir anillos

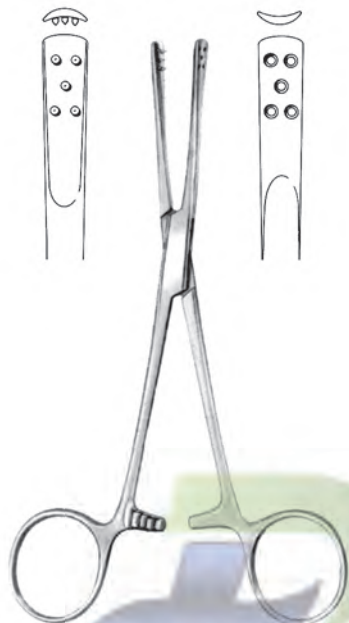

**PENNER**  
PC 14-3619-15  
15 cm/6"



**RADOLF**  
PC 14-3620-13  
13.5 cm/5 1/2"



PC 14-3621-01 saw  
PC 14-3621-02 key

PC 14-3621-00  
17 cm/7"



PC 14-3622-01 saw  
PC 14-3622-02 key

PC 14-3622-00  
17 cm/7"



PC 14-3623-01 saw  
PC 14-3623-02 key

**WALTON**  
PC 14-3623-00  
16 cm/5 1/2"

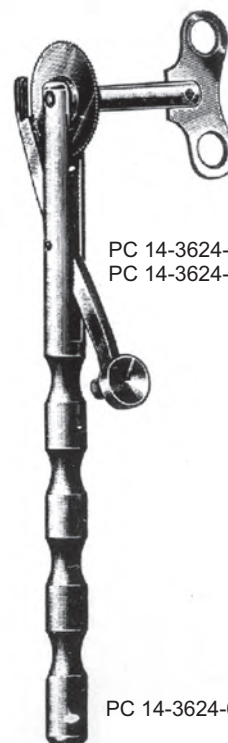

PC 14-3624-01 saw  
PC 14-3624-02 key

PC 14-3624-00



- Bone Spoon ●— EN
- Knochenlöffel ●— DE
- Cucharilla cortantes ●— ES



- EN —● Tendon Stripper, Tendon Tunnel
- DE —● Sehnenstripper, Durchzug
- ES —● Separadores para tendones, para el tunel del tendon



Tendon Stripper, Tendon Tunnel ●— EN  
 Sehnenstripper, Durchzug ●— DE  
 Separadores para tendones, para el túnel del tendón ●— ES



**BUNNEL**  
PC 14-3633-23  
23 cm/9"

PC 14-3634-28  
28.5 cm/11 ¼"

**FISCHER**  
PC 14-3635-31  
31 cm/10 ¼"

- EN —● Lead Hands Nail Instruments
- DE —● Bleihände, Instrumente für Finger-und Zehennägel
- ES —● Manoplas de plomo, Instrumentos para uñas



**IDEAL**

PC 14-3636-00 handle only  
PC 14-3636-01 set



PC 14-3636-02



PC 14-3636-03



PC 14-3636-04



PC 14-3637-01 adult  
PC 14-3637-02 child





## **Pakistan Address**

**Mundeke-Berian, Pasrur  
Sialkot, Pakistan**

**Contact Person: Asif Munir Bajwa  
(Chief Executive)**

**Cell: +92 300 4201777**

**Telephone: +92 333 4201777**

**info@primesialkot.com**

**www.primesialkot.com**

## **Italy Address**

**Italy Office Via Cadorna, 2A  
39100-Bolzano (BZ)**

**Tel: +39 (0) 471 1818343**

**Cell: + 39 327 6243255**

**Email: info@primesialkot.com**

- EN** Plaster Instruments
- DE** Plaster Instrumente
- ES** Instrumentos de yeso

Page 269 to 274



- EN —● Bandage Scissors
- DE —● Verbandschere
- ES —● Tijeras vendaje



**Lister**  
 PC 15-3801-09 09.0 cm/3½"  
 PC 15-3801-11 11.5 cm/4½"  
 PC 15-3801-14 14.0 cm/5½"  
 PC 15-3801-15 15.5 cm/6"  
 PC 15-3801-18 18.0 cm/7"  
 PC 15-3801-20 20.0 cm/8"



**Lister**  
 PC 15-3802-18 18.5 cm/7¼"  
 PC 15-3802-21 21.0 cm/8¼"



**Lister-Excentric**  
 PC 15-3803-16 16 cm/6¼"  
 PC 15-3803-19 19 cm/7½"



**Esmarch**  
 PC 15-3804-20 20 cm/8"  
 PC 15-3804-22 22 cm/8¾"



**Bergmann**  
 PC 15-3805-23 23 cm/9"



**Lorenz**  
 PC 15-3806-23 23 cm/9"

- Bandage Scissors ● EN
- Verbandschere ● DE
- Tijeras vendaje ● ES



Saw edge

PC 15-3807-17  
17 cm/6¾"



**Lange**  
PC 15-3808-18  
18 cm/7"



**Bruns**  
PC 15-3809-24  
24 cm/9½"  
TC



**Smith (Mod. USA)**  
PC 15-3810-16 16 cm  
PC 15-3810-18 18 cm  
PC 15-3810-20 20 cm  
PC 15-3810-23 23 cm



**Knowles**  
PC 15-3811-14  
14 cm/5½"



**Knowles**  
PC 15-3812-14  
14 cm/5½"



PC 15-3813-13  
13 cm/5"



- EN —● Clothing Scissors, Plaster of Paris and Rib Shears  
 DE —● Bekleidung Schere, Plaster of Paris und Rib Shears  
 ES —● Tijeras ropa, yeso y tijeras Costilla



**Maier**  
PC 15-3814-15  
15 cm/6"

**Schweizer**  
PC 15-3815-18  
18 cm/7"

PC 15-3816-23  
23 cm/9"

**Collin**  
PC 15-3817-22  
22 cm/8¾"



**Gluck**  
PC 15-3818-22  
22 cm/8¾"



**Stille**  
PC 15-3819-21  
21 cm/8¼"



**Utility**  
PC 15-3820-15 15.0cm  
PC 15-3820-18 18.0cm  
Available in all colors

Plaster of paris knives and saws ● EN  
 Plaster von Paris Messer und Sägen ● DE  
 Yeso de París cuchillos y sierras ● ES



**Bergmann**  
 PC 15-3821-18  
 18 cm/7"

**Engel**  
 PC 15-3822-14  
 14 cm/5 1/2"

Plaster of paris knives and saws



**Hopkins**  
 PC 15-3823-20  
 20 cm/8"

**Esmarch**  
 PC 15-3824-18  
 18 cm/7"

**Reiner**  
 PC 15-3825-18  
 18 cm/7"

PC 15-3826-21  
 21 cm/8 1/2"

**Wigmore**  
 PC 15-3827-19  
 19 cm/7 1/2"

- EN —● Plaster shears
- DE —● Gipsscheren
- ES —● Tijeras para yeso



PC 15-3828-20 20.0cm



**Seutin**  
PC 15-3829-23 23.0cm



**Bruns**  
PC 15-3830-24 24.0cm



**Bruns (serrated)**  
PC 15-3831-24 24.0cm



**Stille-Mini**  
PC 15-3832-20 20.0cm



**Stille**  
PC 15-3833-20 20.0cm  
PC 15-3833-23 23.0cm  
PC 15-3833-26 26.0cm  
PC 15-3833-30 30.0cm  
PC 15-3833-37 37.0cm



**Stille**  
PC 15-3834-24 24.0cm

Plaster Cast Instruments ● EN  
 Plaster Cast Instrumente ● DE  
 Instrumentos Yeso ● ES



**Haglund-Stille**  
 PC 15-3835-28  
 28 cm/11"



**USA Mod Spreader**  
 PC 15-3836-23  
 23 cm/9"



**Wolff-Boehler**  
 PC 15-3837-18 18 cm/7"  
 PC 15-3837-20 20 cm/8"  
 PC 15-3837-22 22 cm/8½"  
 PC 15-3837-24 24 cm/9½"  
 PC 15-3837-26 26 cm/10½"



**Hennig**  
 PC 15-3838-28  
 28 cm/11"



**Beeson**  
 PC 15-3839-30  
 30 cm/12"



EN

Retractors

DE

Wundhaken und -sperrer

ES

Separadores

Page 275 to 345

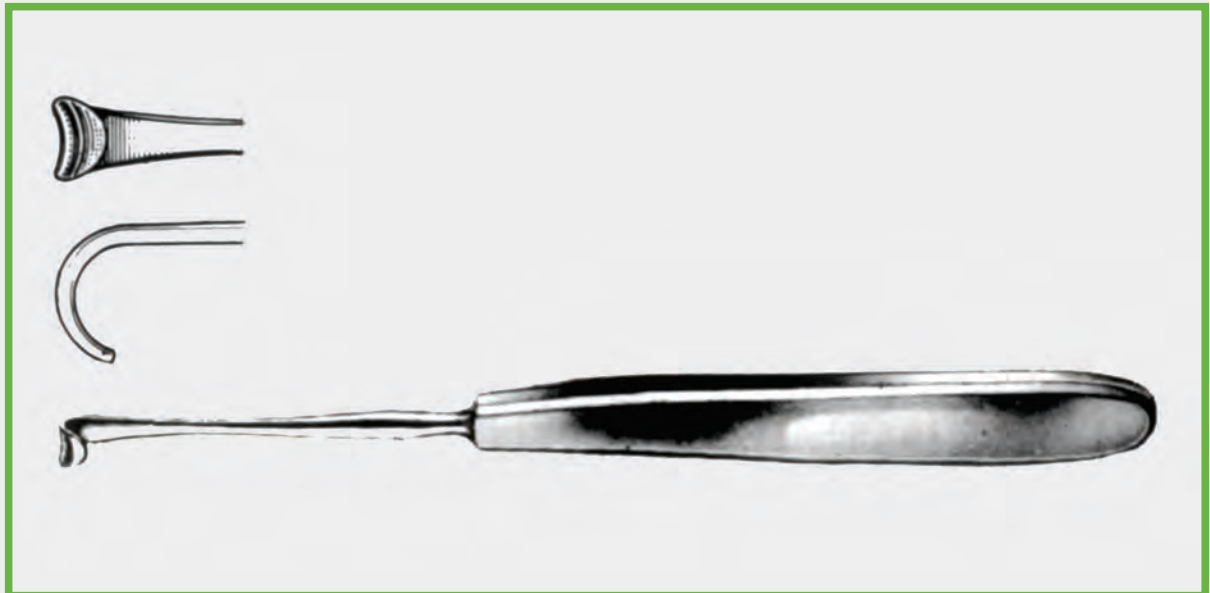

- EN —●— Retractors
- DE —●— Wundhaken
- ES —●— Separadores



**CUSHING**

20 cm/7 7/8"	PC 16-4205-20	PC 16-4206-20	PC 16-4207-20
24 cm/9 1/2"	PC 16-4208-24	PC 16-4209-24	PC 16-4210-20
	8 mm	10 mm	12 mm

20 cm/7 7/8"	PC 16-4211-20	PC 16-4212-20	PC 16-4213-20
24 cm/9 1/2"	PC 16-4214-24	PC 16-4215-24	PC 16-4216-24
	14 mm	16 mm	18 mm

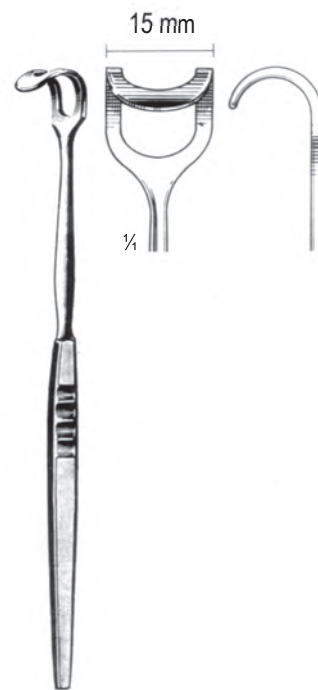

**HANDTE**  
PC 16-4217-17  
17 cm/6 3/4"

Retractors ●— EN  
 Wundhaken ●— DE  
 Separadores ●— ES

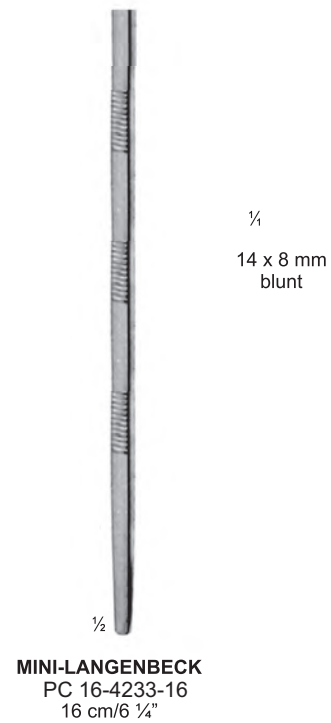
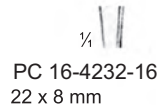
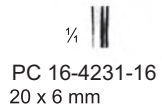
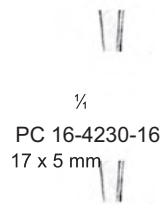
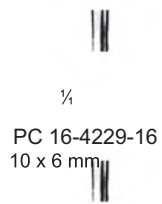
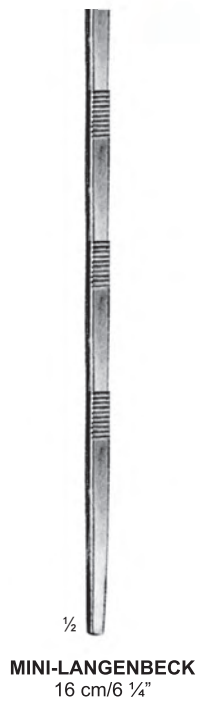
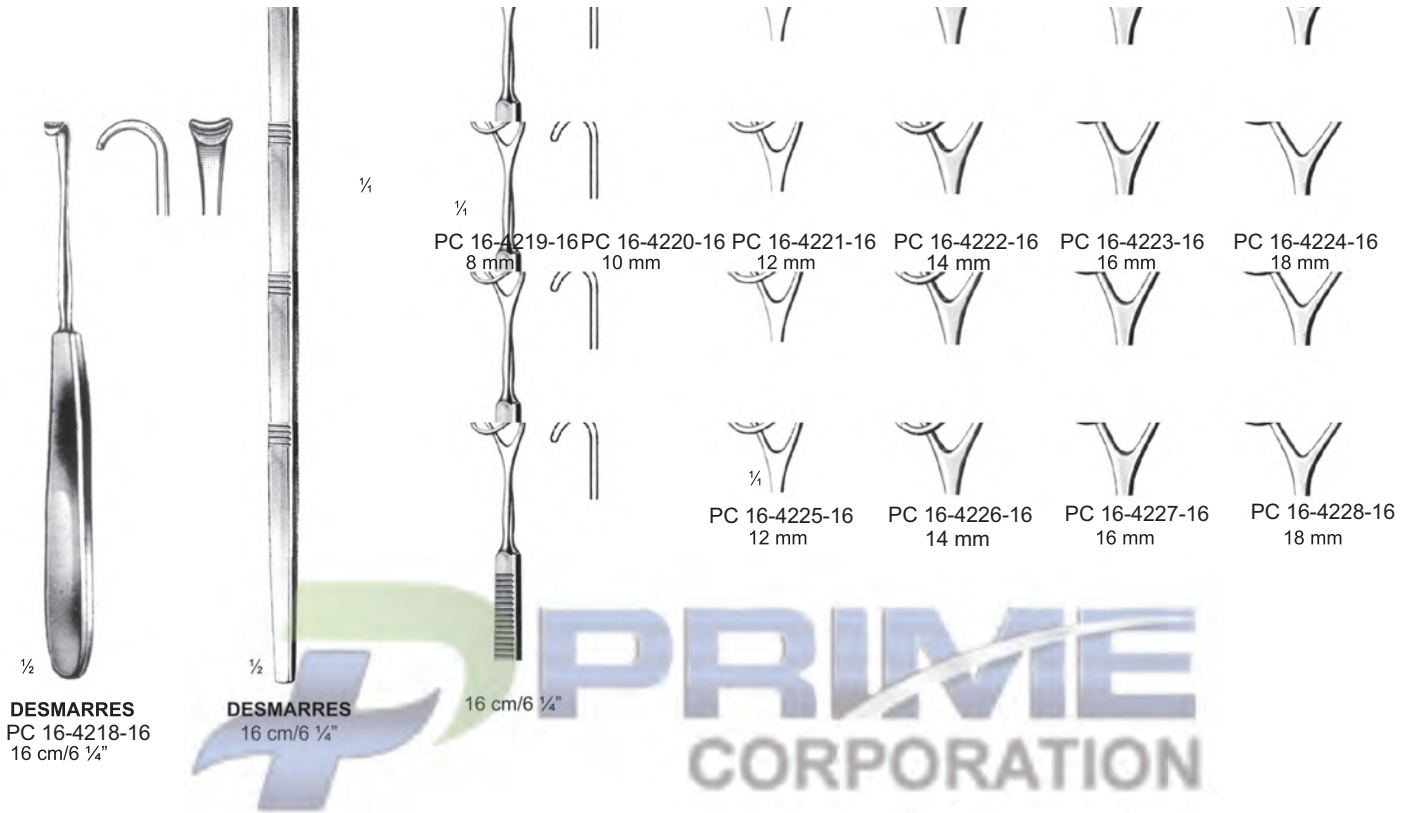

- EN —● Retractors
- DE —● Wundhaken
- ES —● Separadores





- Retractors ●— EN
- Wundhaken ●— DE
- Separadores ●— ES



**LANGENBECK**  
22 cm/8 ½"

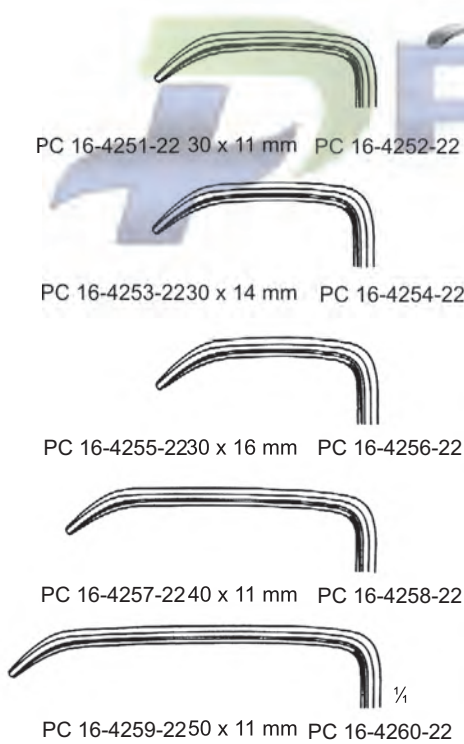

**LANGENBECK**  
21 cm/8 ¼"



**LANGENBECK**  
PC 16-4261-21  
21 cm/8 ¼"



**LANGENBECK**  
PC 16-4262-21  
21 cm/8 ¼"

- EN —● Retractors
- DE —● Wundhaken
- ES —● Separadores



**MINI-ZENKER**  
PC 16-4263-18  
18 cm/7 1/8"  
10 X 3 mm

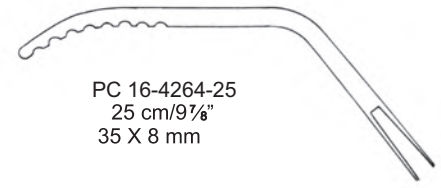

PC 16-4264-25  
25 cm/9 7/8"  
35 X 8 mm

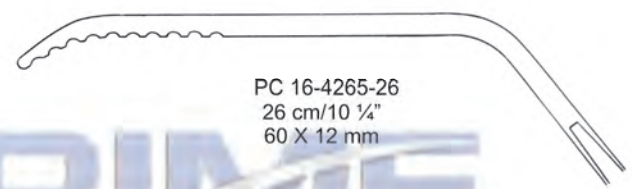
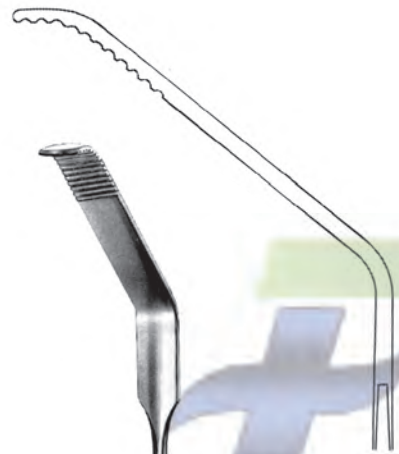

PC 16-4265-26  
26 cm/10 1/4"  
60 X 12 mm

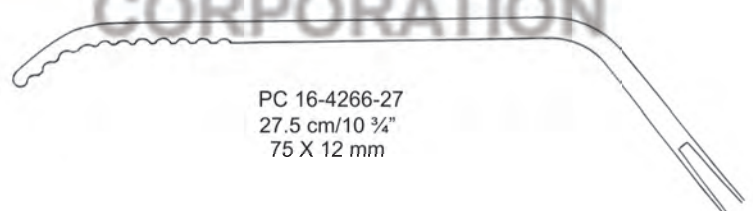

PC 16-4266-27  
27.5 cm/10 3/4"  
75 X 12 mm

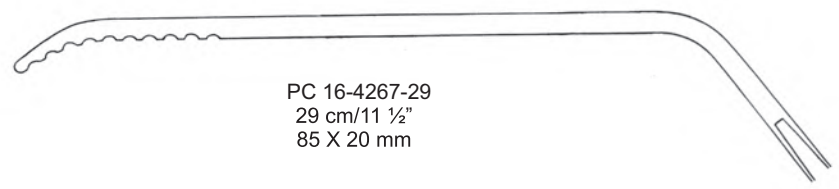

PC 16-4267-29  
29 cm/11 1/2"  
85 X 20 mm

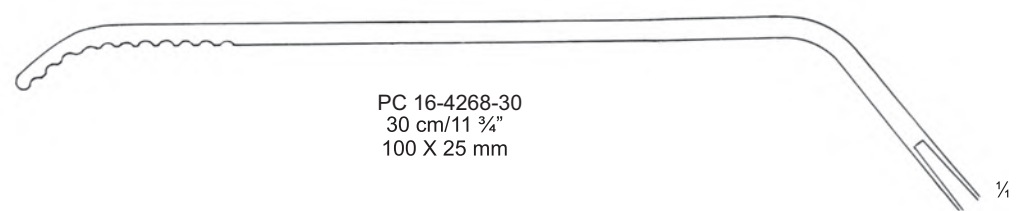

PC 16-4268-30  
30 cm/11 3/4"  
100 X 25 mm



**ZENKER**

Retractors — EN  
 Wundhaken — DE  
 Separadores — ES



TRACHEAL  
 16 cm/6 1/4"  
 sharp



PC 16-4269-16



PC 16-4270-16



PC 16-4271-16



PC 16-4272-16



TRACHEAL  
 16 cm/6 1/4"  
 blunt



PC 16-4273-16



PC 16-4274-16



PC 16-4275-16



PC 16-4276-16



TRACHEAL  
 16 cm/6 1/4"  
 semi-sharp



PC 16-4277-16



PC 16-4278-16



PC 16-4279-16



PC 16-4280-16



17 cm/6 3/4"  
 sharp



PC 16-4281-17



PC 16-4282-17



PC 16-4283-17



PC 16-4284-17



PC 16-4285-17



PC 16-4286-17



PC 16-4287-17



PC 16-4288-17



PC 16-4289-17



PC 16-4290-17



PC 16-4290-17  
 blunt

- EN —● Retractors
- DE —● Wundhaken
- ES —● Separadores

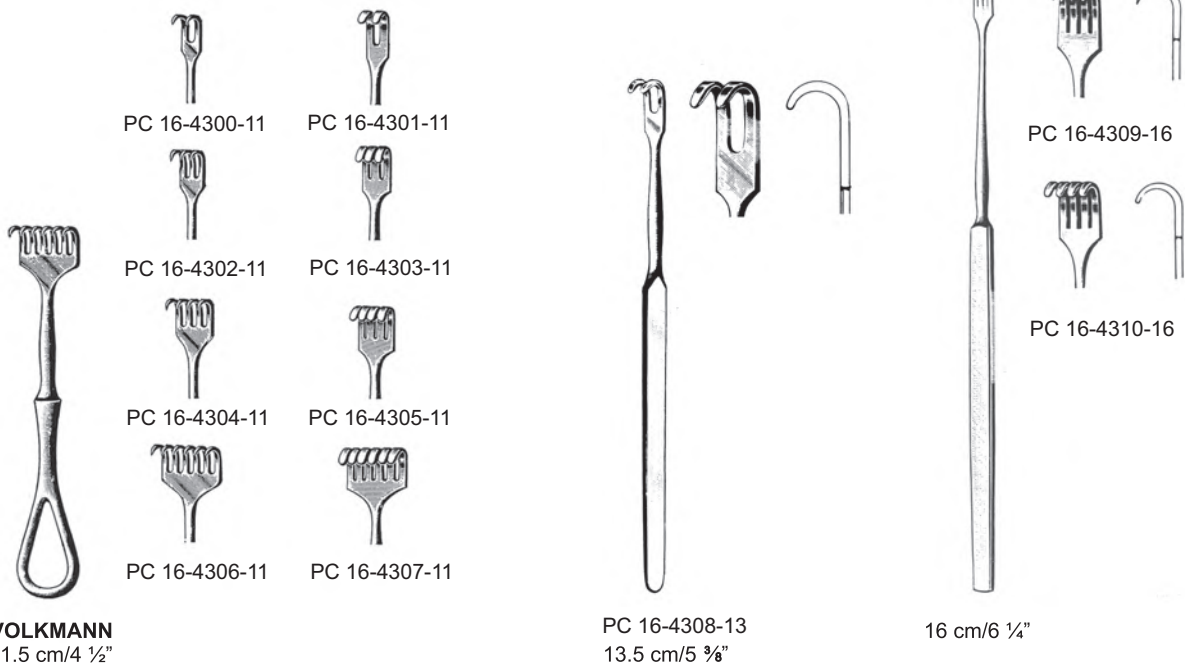
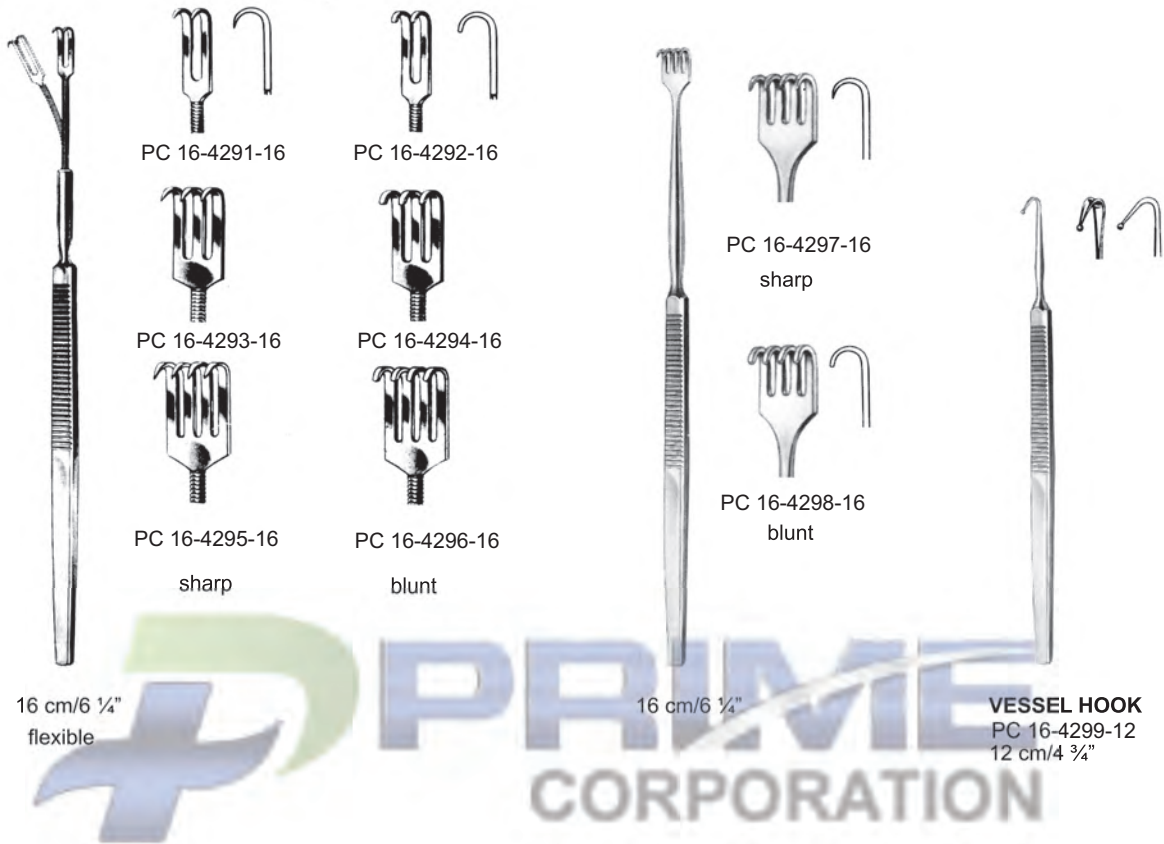

Measurements of retractors: Depth x Width



Retractors ●— EN  
 Wundhaken ●— DE  
 Separadores ●— ES

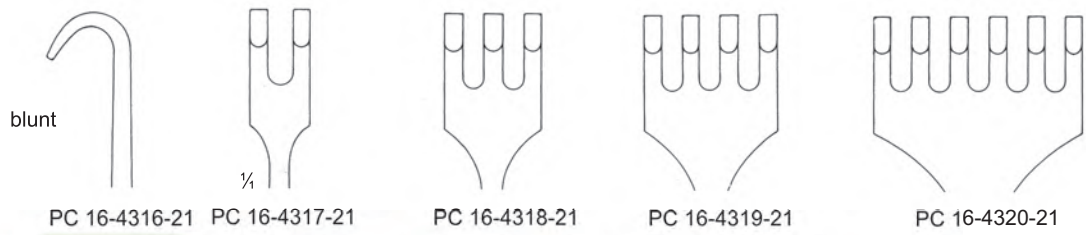
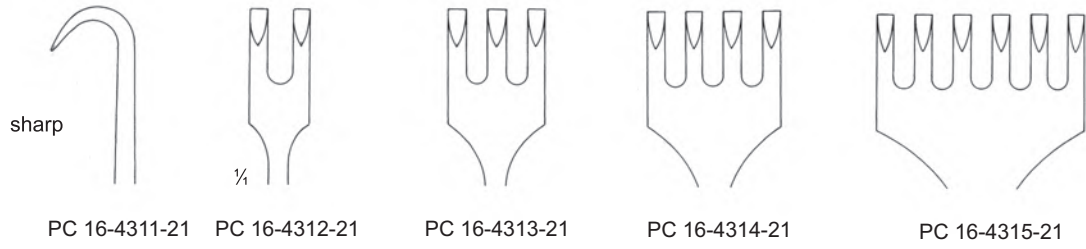

**VOLKMANN**  
21.5 cm/8 1/2"



**CUSHING**  
 PC 16-4321-21  
 21.5 cm/8 1/2"  
 PC 16-4322-25  
 25 cm/10"



**CUSHING**  
 PC 16-4323-21  
 24.5 cm/9 5/8"  
 PC 16-4324-28  
 28 cm/11"

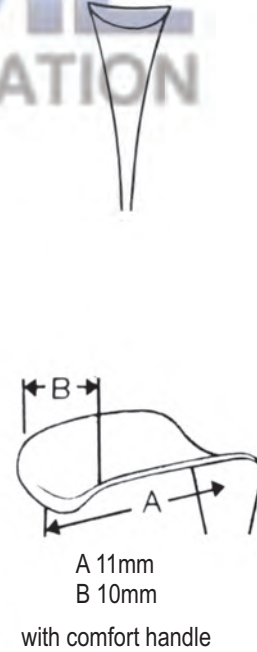

- EN —● Retractors
- DE —● Wundhaken
- ES —● Separadores

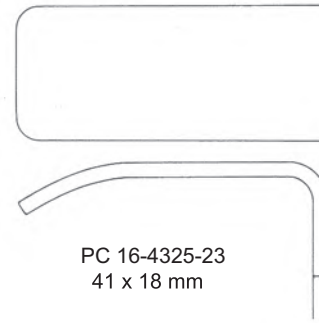

PC 16-4325-23  
41 x 18 mm

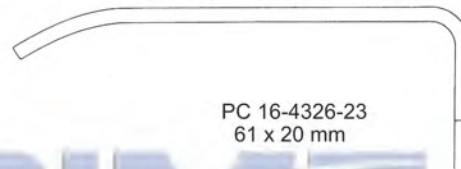

PC 16-4326-23  
61 x 20 mm



**KOCHER**  
23 cm/9"

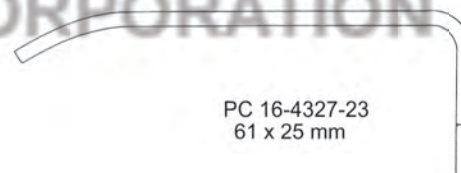

PC 16-4327-23  
61 x 25 mm

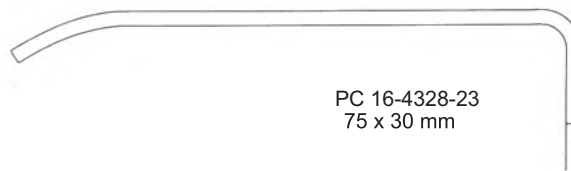

PC 16-4328-23  
75 x 30 mm

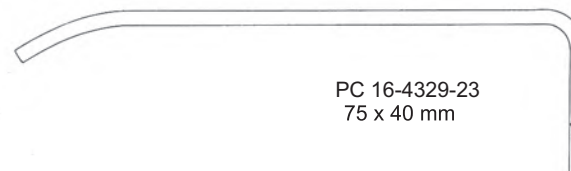

PC 16-4329-23  
75 x 40 mm

¼

- Retractors ● — EN
- Wundhaken ● — DE
- Separadores ● — ES



**KOCHER-LANGENBECK**  
21.5 cm/8 1/2"

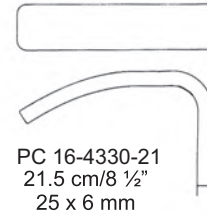

PC 16-4330-21  
21.5 cm/8 1/2"  
25 x 6 mm

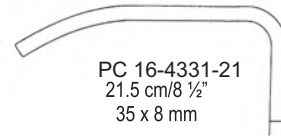

PC 16-4331-21  
21.5 cm/8 1/2"  
35 x 8 mm

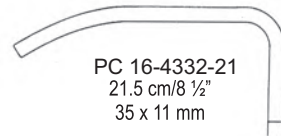

PC 16-4332-21  
21.5 cm/8 1/2"  
35 x 11 mm

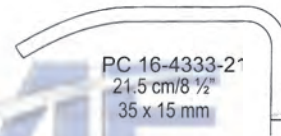

PC 16-4333-21  
21.5 cm/8 1/2"  
35 x 15 mm



PC 16-4334-21  
21.5 cm/8 1/2"  
40 x 11 mm

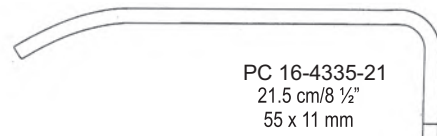

PC 16-4335-21  
21.5 cm/8 1/2"  
55 x 11 mm

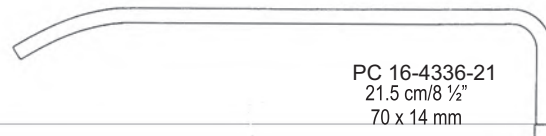

PC 16-4336-21  
21.5 cm/8 1/2"  
70 x 14 mm



PC 16-4337-21  
21.5 cm/8 1/2"  
80 x 12 mm

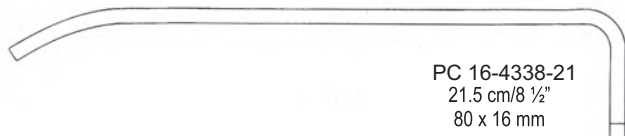

PC 16-4338-21  
21.5 cm/8 1/2"  
80 x 16 mm

Measurements of retractors: Depth x Width

- EN —● Retractors
- DE —● Wundhaken
- ES —● Separadores



**KOCHER-LANGENBECK**  
21.5 cm/8 1/2"

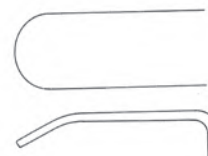

**PC 16-4339-21**  
21.5 cm/8 1/2"  
25 x 10 mm



**PC 16-4340-21**  
21.5 cm/8 1/2"  
40 x 13 mm



**PC 16-4341-21**  
21.5 cm/8 1/2"  
60 x 13 mm



**PC 16-4342-21**  
21.5 cm/8 1/2"  
40 x 18 mm



**PC 16-4343-21**  
21.5 cm/8 1/2"  
60 x 18 mm



**PC 16-4344-21**  
21.5 cm/8 1/2"  
85 x 18 mm



**PC 16-4345-21**  
21.5 cm/8 1/2"  
60 x 25 mm



**PC 16-4346-21**  
21.5 cm/8 1/2"  
85 x 25 mm

Measurements of retractors: Depth x Width



- Retractors ●— EN
- Wundhaken ●— DE
- Separadores ●— ES



**OBWEGESER**  
24 cm/9 1/2"  
bent downwards

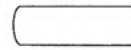

PC 16-4347-24  
16 x 5 mm

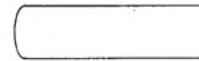

PC 16-4348-24  
25 x 7 mm

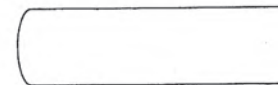

PC 16-4349-24  
35 x 10 mm



PC 16-4350-24  
42 x 10 mm



PC 16-4351-24  
55 x 12 mm

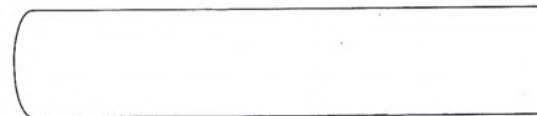

PC 16-4352-24  
70 x 14 mm

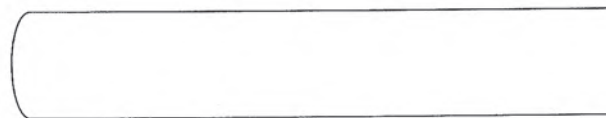

PC 16-4353-24  
80 x 16 mm

Measurements of retractors: Depth x Width

- EN —● Retractors
- DE —● Wundhaken
- ES —● Separadores

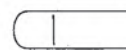

PC 16-4354-24  
16 x 5 mm



PC 16-4355-24  
25 x 7 mm

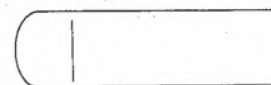

PC 16-4356-24  
35 x 10 mm



PC 16-4357-24  
42 x 10 mm



PC 16-4358-24  
55 x 12 mm

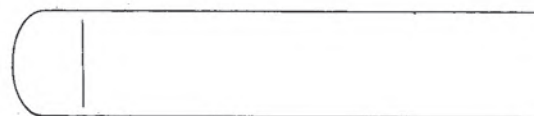

PC 16-4359-24  
70 x 14 mm

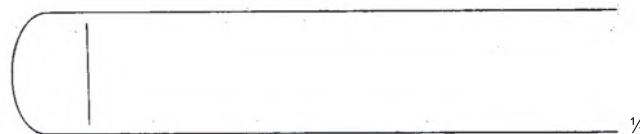

PC 16-4360-24  
80 x 16 mm



**OBWEGESER**  
24cm/9 1/2"  
bent upward

Measurements of retractors: Depth x Width

Retractors — EN  
 Wundhaken — DE  
 Separadores — ES

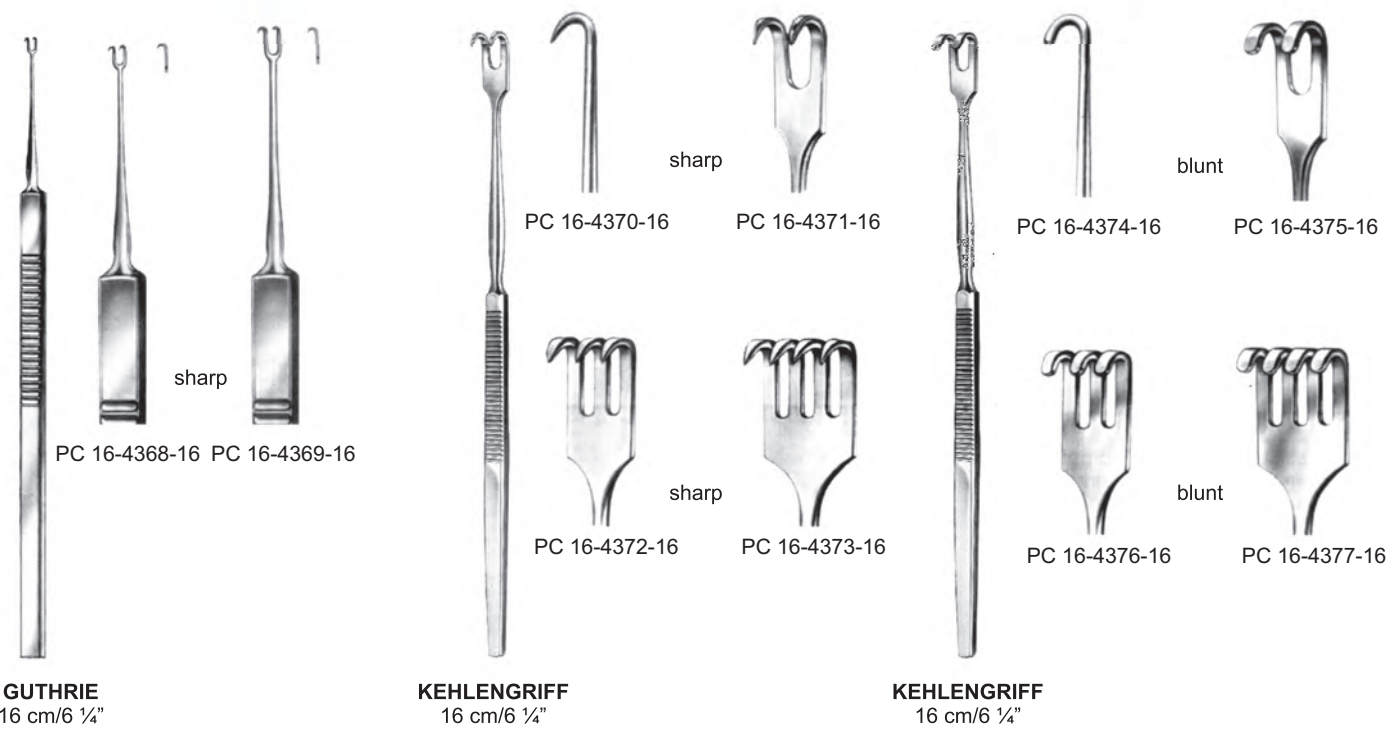
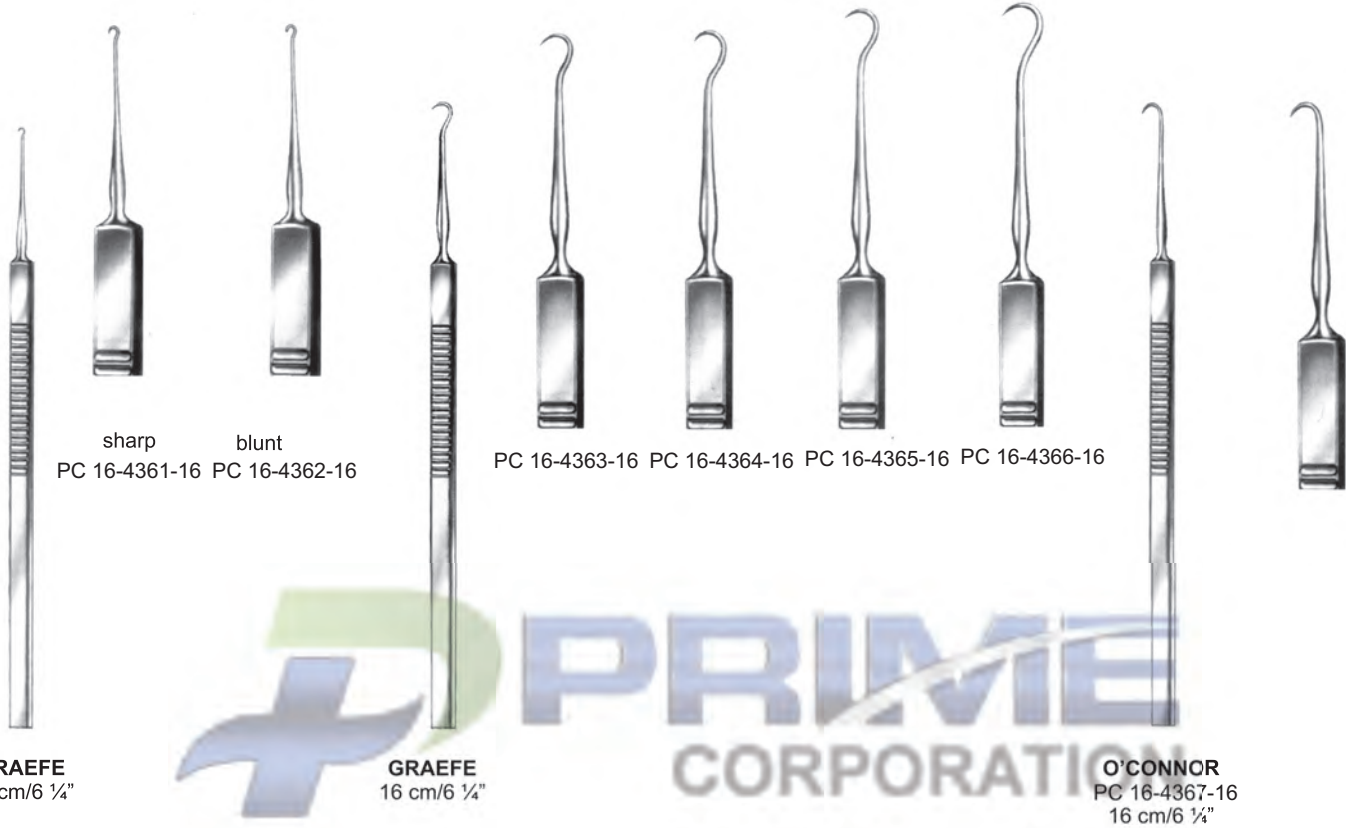

Measurements of retractors: Depth x Width

- EN —● Retractors
- DE —● Wundhaken
- ES —● Separadores

16 x 5 mm



**CANNY RYALL**  
 PC 16-4378-1515mm  
 PC 16-4378-2020mm  
 PC 16-4378-2525mm  
 PC 16-4378-3030mm



**CANNY RYALL**  
 PC 16-4379-177 cm/6 3/4"



PC 16-4382-23



**CANNY RYALL**  
 PC 16-4380-177 cm/6 3/4"



PC 16-4383-23

Sharp



**CZERNEY**  
 PC 16-4381-1717 cm/6 3/4"

38 x 22 mm



PC 16-4384-23



23 cm/9"



- Retractors ●— EN
- Wundhaken ●— DE
- Separadores ●— ES

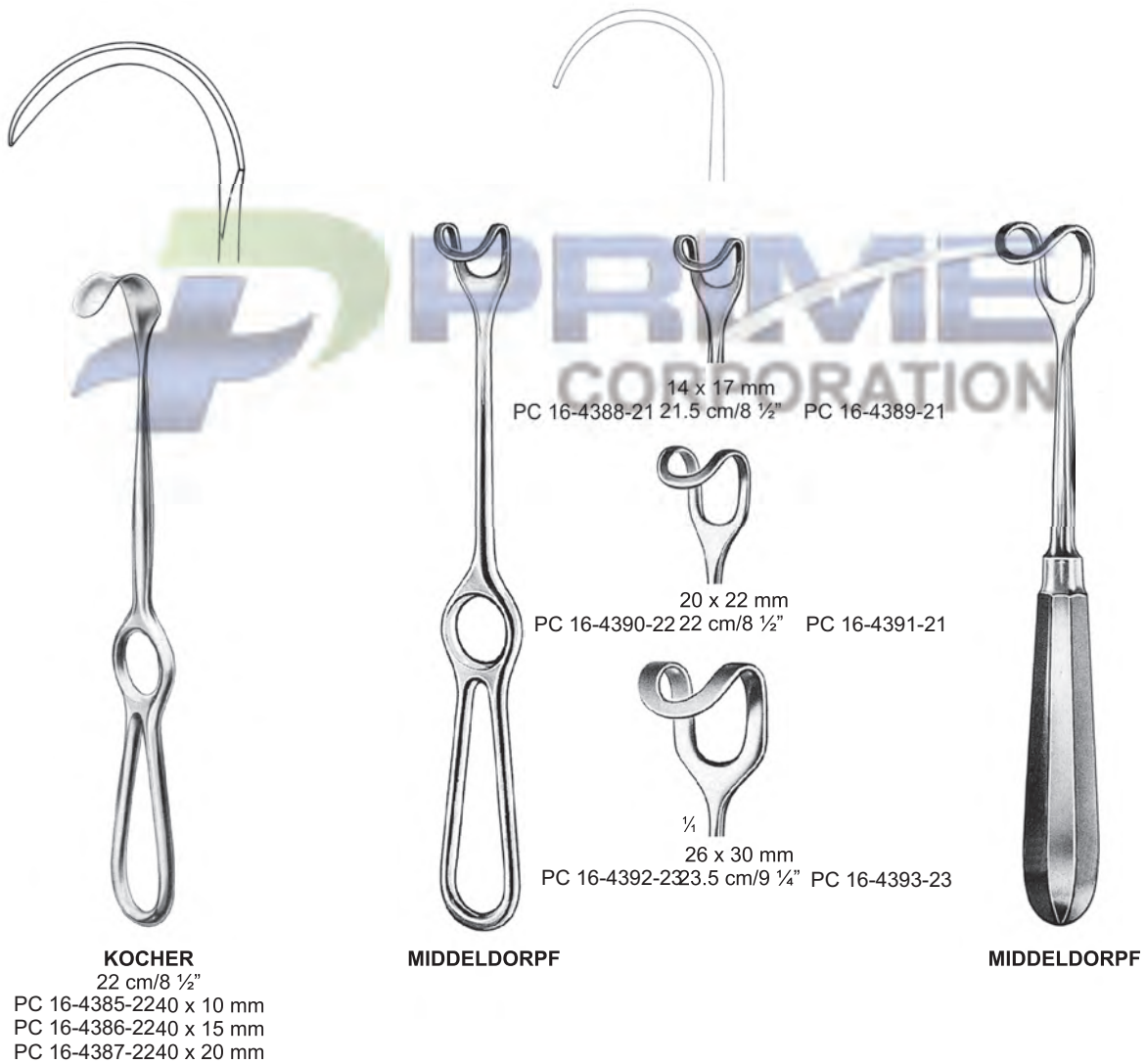

Measurements of retractors: Depth x Width

- EN —● Retractors
- DE —● Wundhaken
- ES —● Separadores

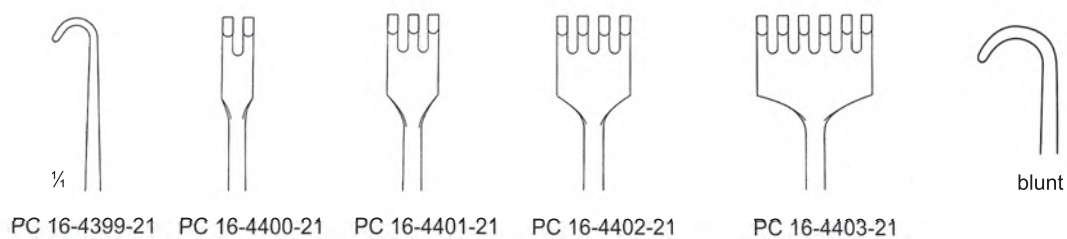
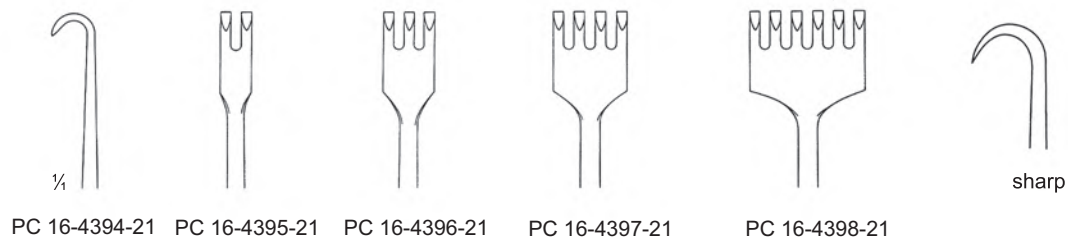

**VOLKMANN**  
21.5 cm/8 1/2"

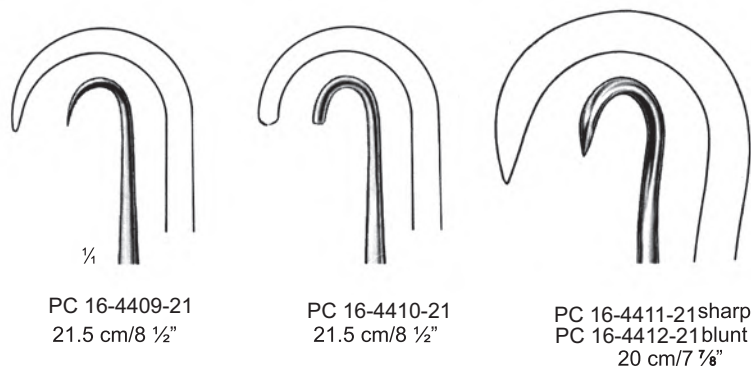

Measurements of retractors: Depth x Width

Retractors — EN  
 Wundhaken — DE  
 Separadores — ES



**KOCHER**  
22 cm/8 1/2"



**OLLIER**  
PC 16-4432-22  
22.5 cm/8 3/4"



**WASSMUND**  
PC 16-4433-20  
20 cm/7 7/8"

Measurements of retractors: Depth x Width

- EN —● Retractors
- DE —● Wundhaken
- ES —● Separadores

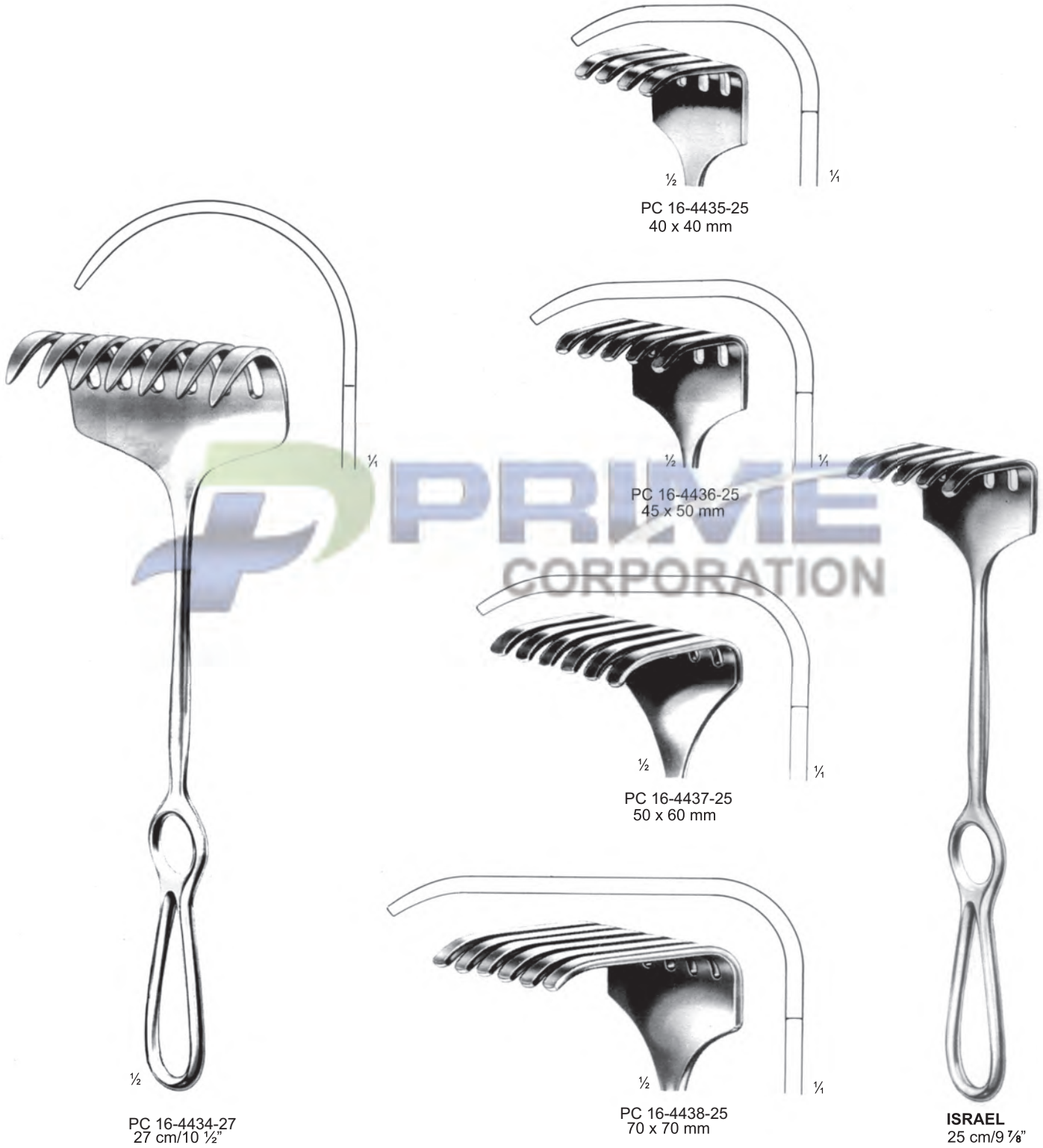

Measurements of retractors: Depth x Width



- Retractors ●— EN
- Wundhaken ●— DE
- Separadores ●— ES

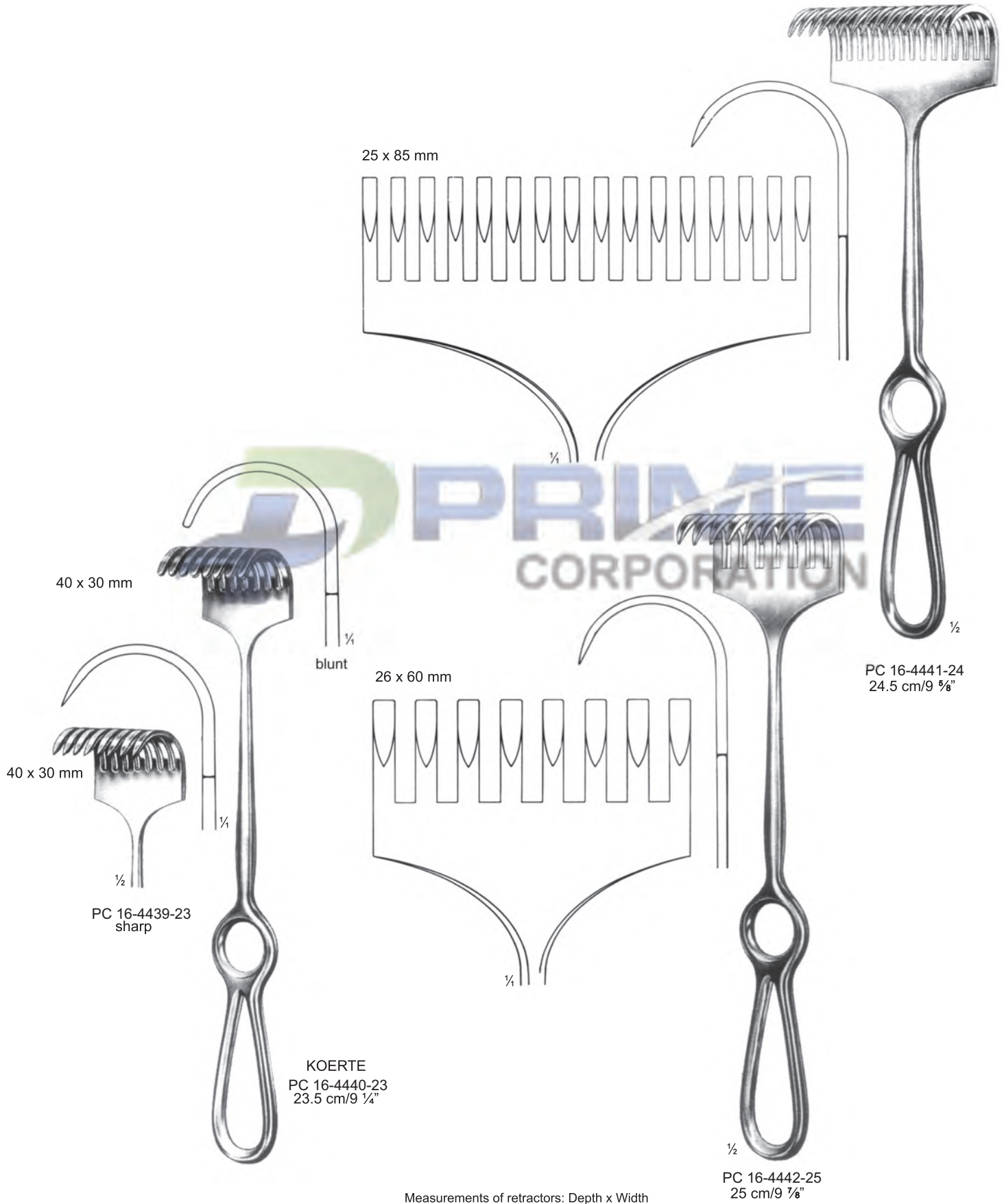

- EN —● Retractors
- DE —● Wundhaken
- ES —● Separadores

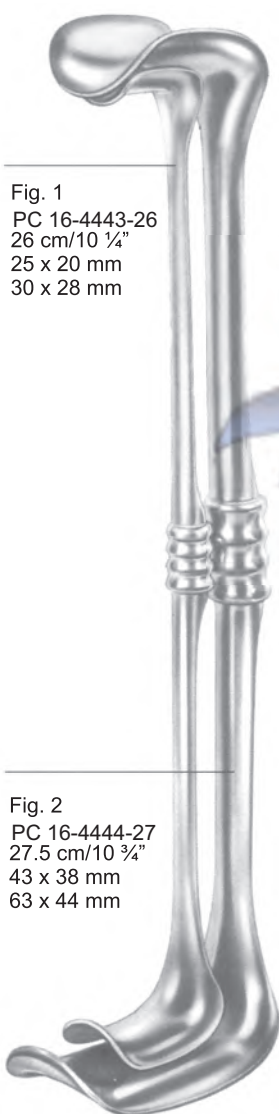

Fig. 1  
PC 16-4443-26  
26 cm/10 1/4"  
25 x 20 mm  
30 x 28 mm

Fig. 2  
PC 16-4444-27  
27.5 cm/10 3/4"  
43 x 38 mm  
63 x 44 mm

**RICHARDSON-EASTMAN**  
PC 16-4445-1  
Set Fig. 1 + 2



**RICHARDSON**

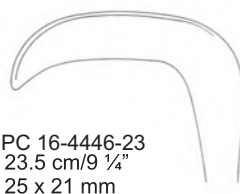

PC 16-4446-23  
23.5 cm/9 1/4"  
25 x 21 mm

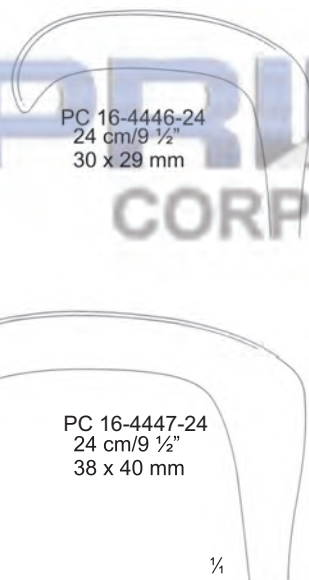

PC 16-4446-24  
24 cm/9 1/2"  
30 x 29 mm



PC 16-4447-24  
24 cm/9 1/2"  
38 x 40 mm



**RICHARDSON**  
PC 16-4448-24  
24 cm/9 1/2"

**KELLY**  
PC 16-4449-2662 x 50 mm  
PC 16-4450-2670 X 65 mm  
26 cm/10 1/4"

- Retractors ●— EN
- Wundhaken ●— DE
- Separadores ●— ES



- EN —● Retractors
- DE —● Wundhaken
- ES —● Separadores

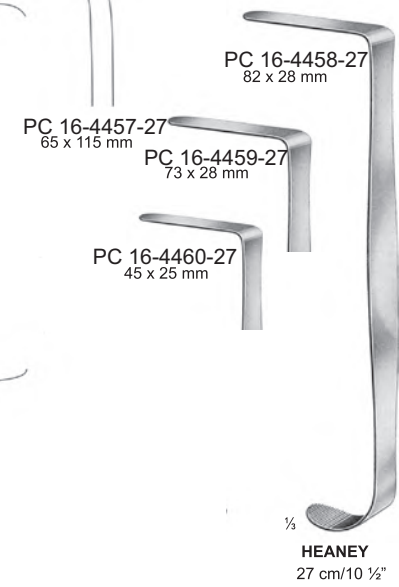
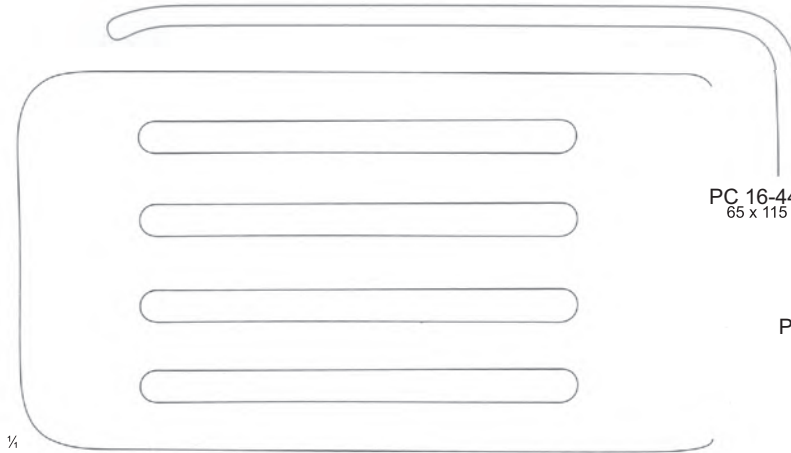
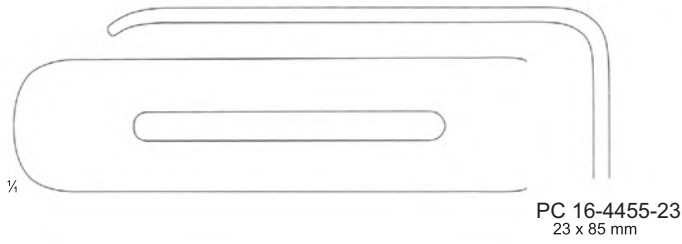



- Abdominal Retractors ● EN
- Bauchdeckenhalter ● DE
- Separadores abdominales ● ES



**DOYEN**  
PC 16-4461-25  
25 cm/9 7/8"

**KOCHER**  
PC 16-4462-22  
22.5 cm/8 3/4"

<b>KOCHER</b>	Total length		Blade
	cm	in.	
PC 16-4463-25	25	9 7/8"	80 x 45
PC 16-4464-25	25	9 7/8"	80 x 55
PC 16-4465-25	25	9 7/8"	80 x 65

**TUFFIER**  
PC 16-4466-21  
21.5 cm/8 1/2"

Measurements of retractors: Depth x width

- EN —● Retractors, Abdominal Retractors  
 DE —● Wundhaken, Bauchdeckenhalter  
 ES —● Separadores, Separadores abdominales



PC 16-4467-25  
 25 cm/9 7/8"  
 87 x 28 mm

PC 16-4468-25  
 25 cm/9 7/8"  
 97 x 31 mm

PC 16-4469-25  
 26 cm/10 1/4"  
 117 x 52 mm



DOYEN-STILLE

- Abdominal Retractors ● EN
- Bauchdeckenhalter ● DE
- Separadores abdominales ● ES



PC 16-4470-27  
27 cm/10 1/2"  
43 x 45 mm



PC 16-4471-27  
27 cm/10 1/2"  
52 x 50 mm

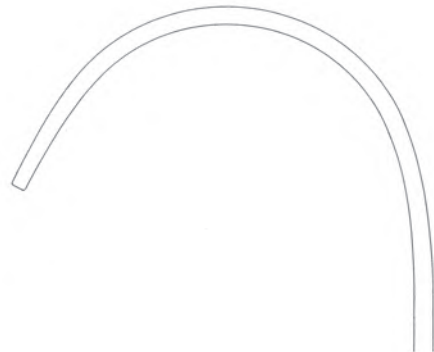

PC 16-4471-28  
28 cm/11"  
52 x 70 mm

MIDDELDORPF

- EN —● Abdominal Retractors
- DE —● Bauchdeckenhalter
- ES —● Separadores abdominales



**FRITSCH**



PC 16-4472-23  
23.5 cm/9 1/4"  
37 x 31 mm



PC 16-4472-24  
24 cm/9 1/2"  
38 x 40 mm



PC 16-4472-25  
25 cm/9 7/8"  
43 x 51 mm



PC 16-4473-25  
25 cm/9 7/8"  
49 x 61 mm

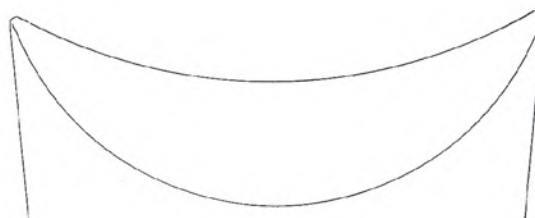

PC 16-4474-25  
25.5 cm/10"  
48 x 75 mm

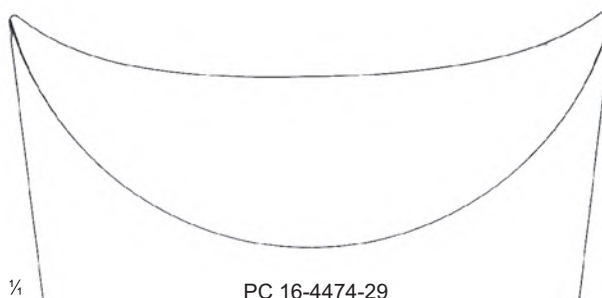

PC 16-4474-29  
29.5 cm/11 5/8"  
65 x 85 mm



- Retractors, Abdominal Retractors ●— EN
- Wundhaken, Bauchdeckenhalter ●— DE
- Separadores, Separadores abdominales ●— ES

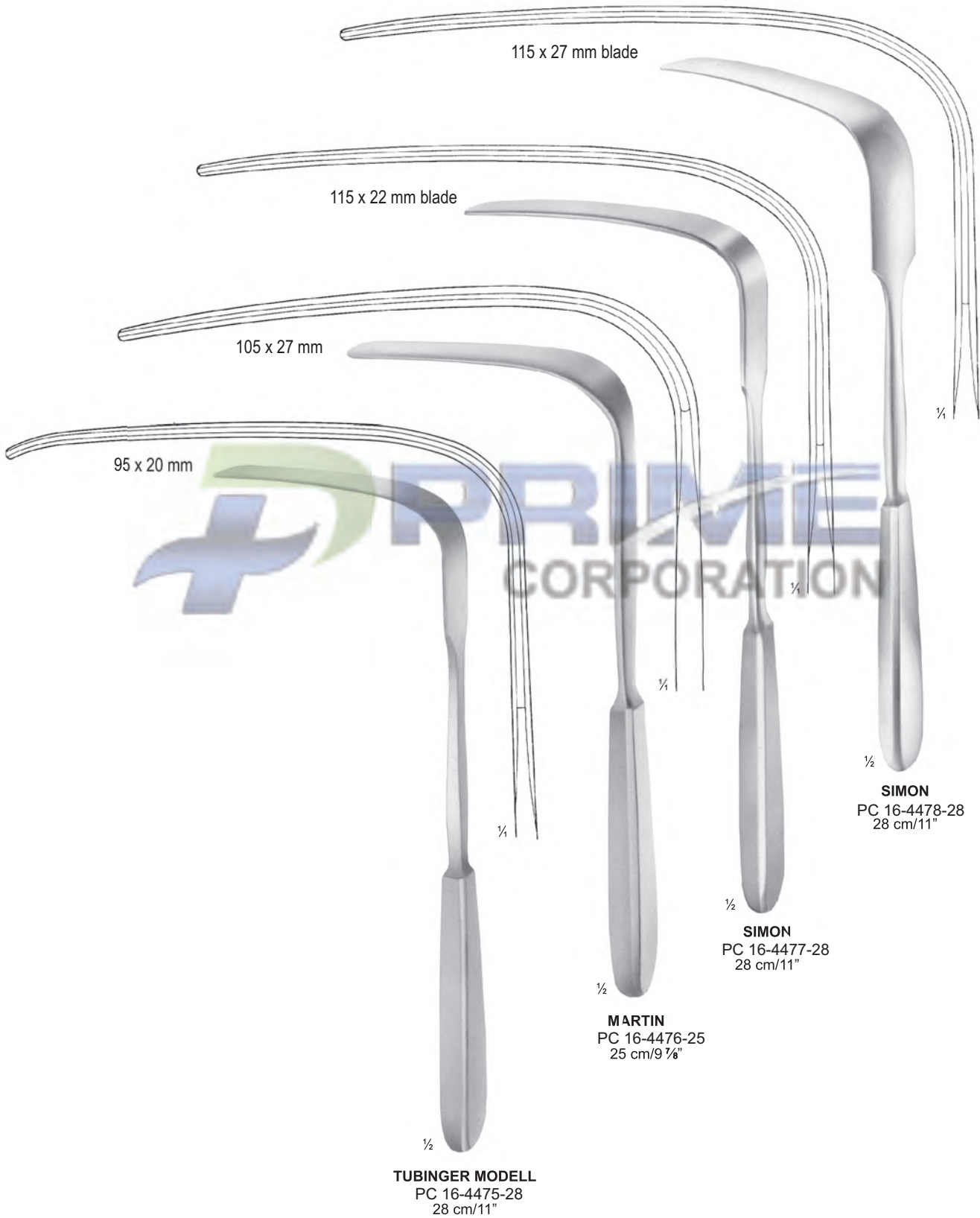

Measurements of retractors: Depth x width

- EN —● Retractors
- DE —● Wundhaken
- ES —● Separadores



**DAVIDSON**  
PC 16-4479-18  
75 x 93 mm  
18.5 cm/7 1/4"

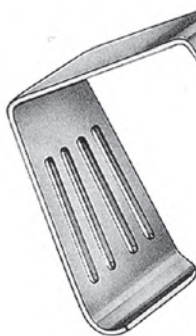

**DAVIDSON**  
19 cm/7 1/2"  
(Scapula)

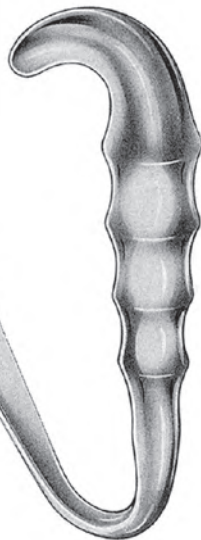

PC 16-4480-19  
80 x 54 mm

1/2

**SAUERBRUCH**  
PC 16-4481-25  
25.5 cm/10"

**BRUNNER**  
PC 16-4482-24  
24 cm/9 1/2"

- Retractors ● EN
- Wundhaken ● DE
- Separadores ● ES

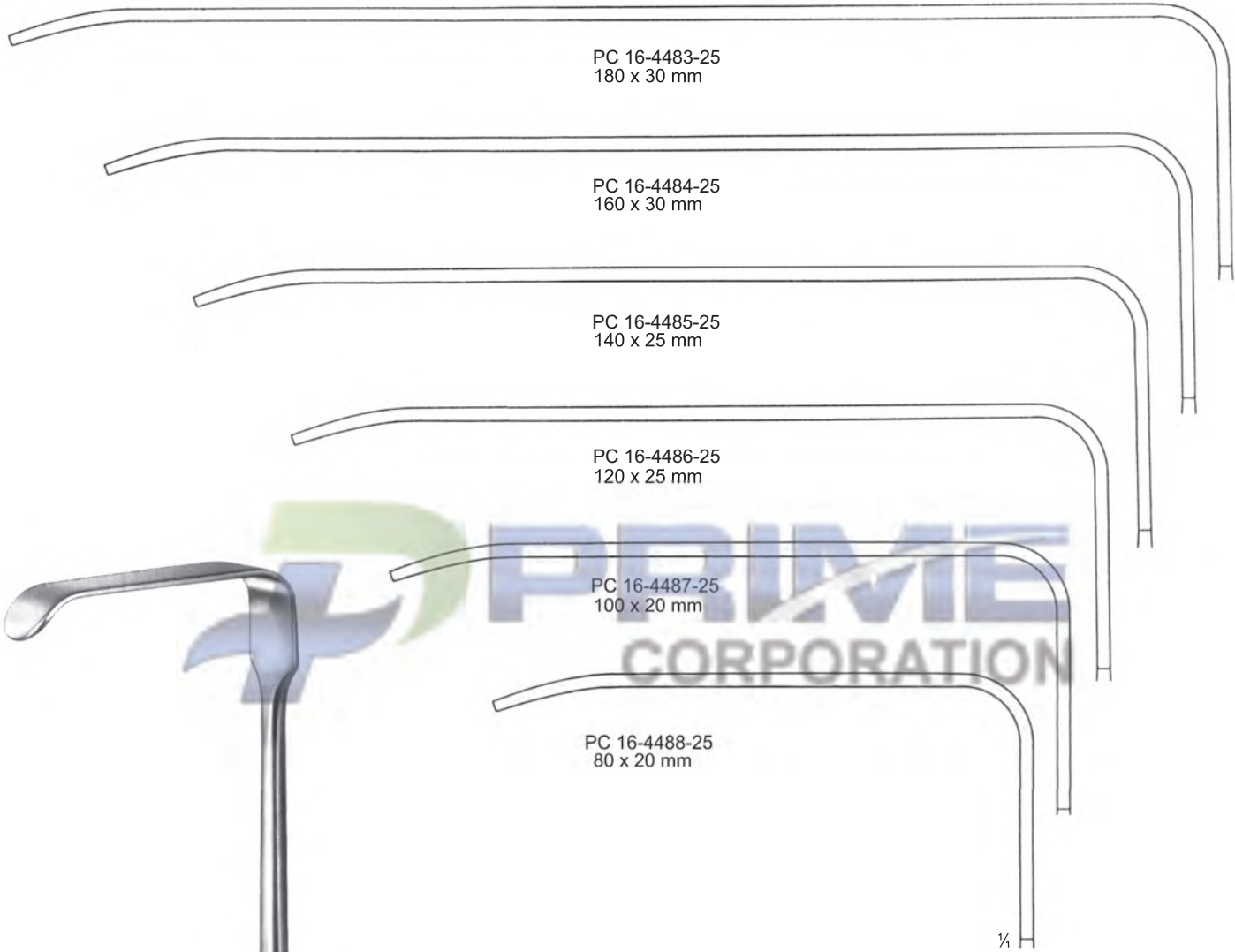

- EN —● Retractors
- DE —● Wundhaken
- ES —● Separadores

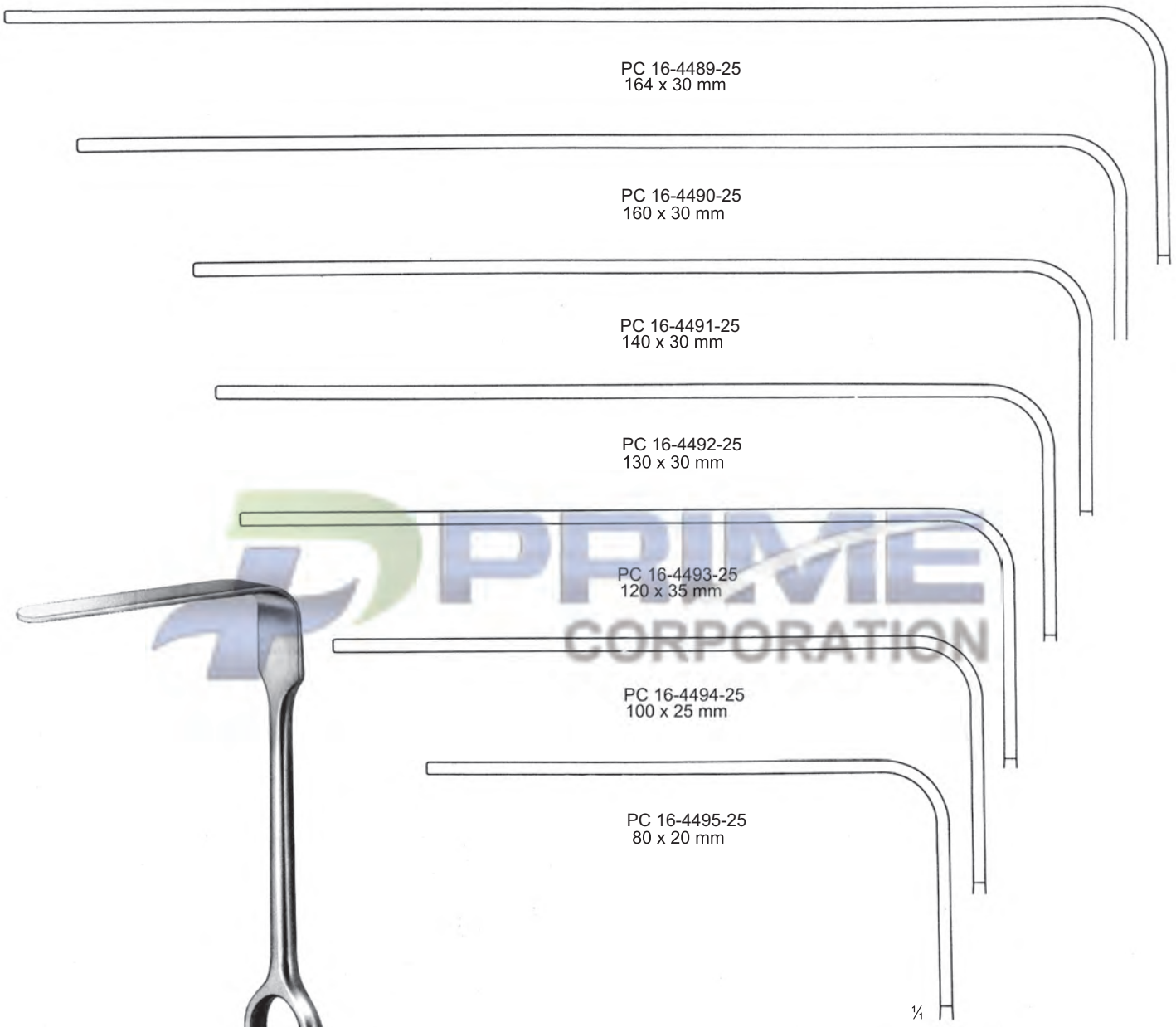

**BRUNNER**  
25.5 cm/10"



- Retractors ● — EN
- Wundhaken ● — DE
- Separadores ● — ES



Fig. 2 = 137 x 65 mm

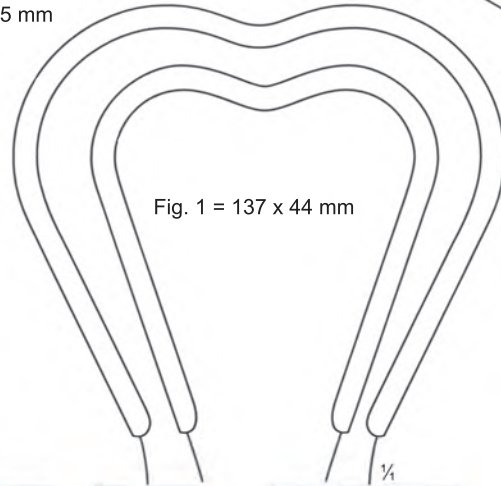
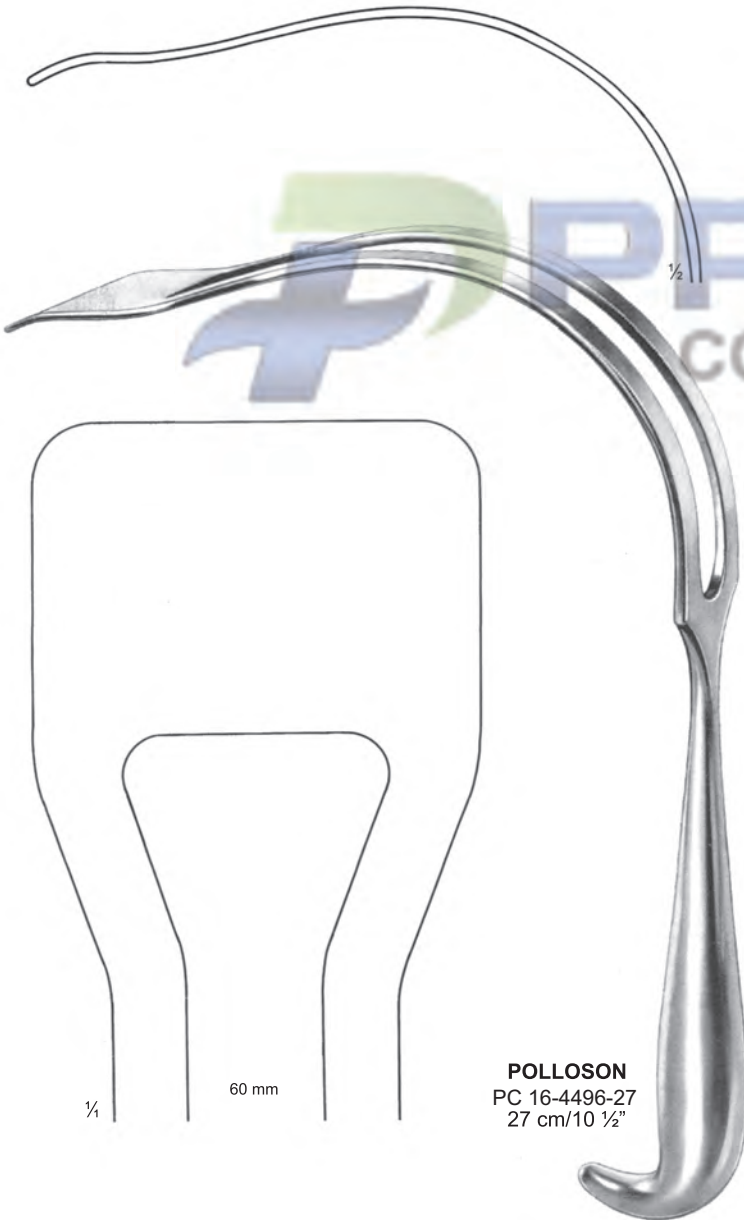

Fig. 1 = 137 x 44 mm



**POLLOSON**  
PC 16-4496-27  
27 cm/10 1/2"



**HARRINGTON**  
PC 16-4497-32= Fig. 1  
PC 16-4498-32= Fig. 2  
32 cm/12 1/2"

1/4

60 mm

1/2

1/4

- EN —● Retractors
- DE —● Wundhaken
- ES —● Separadores

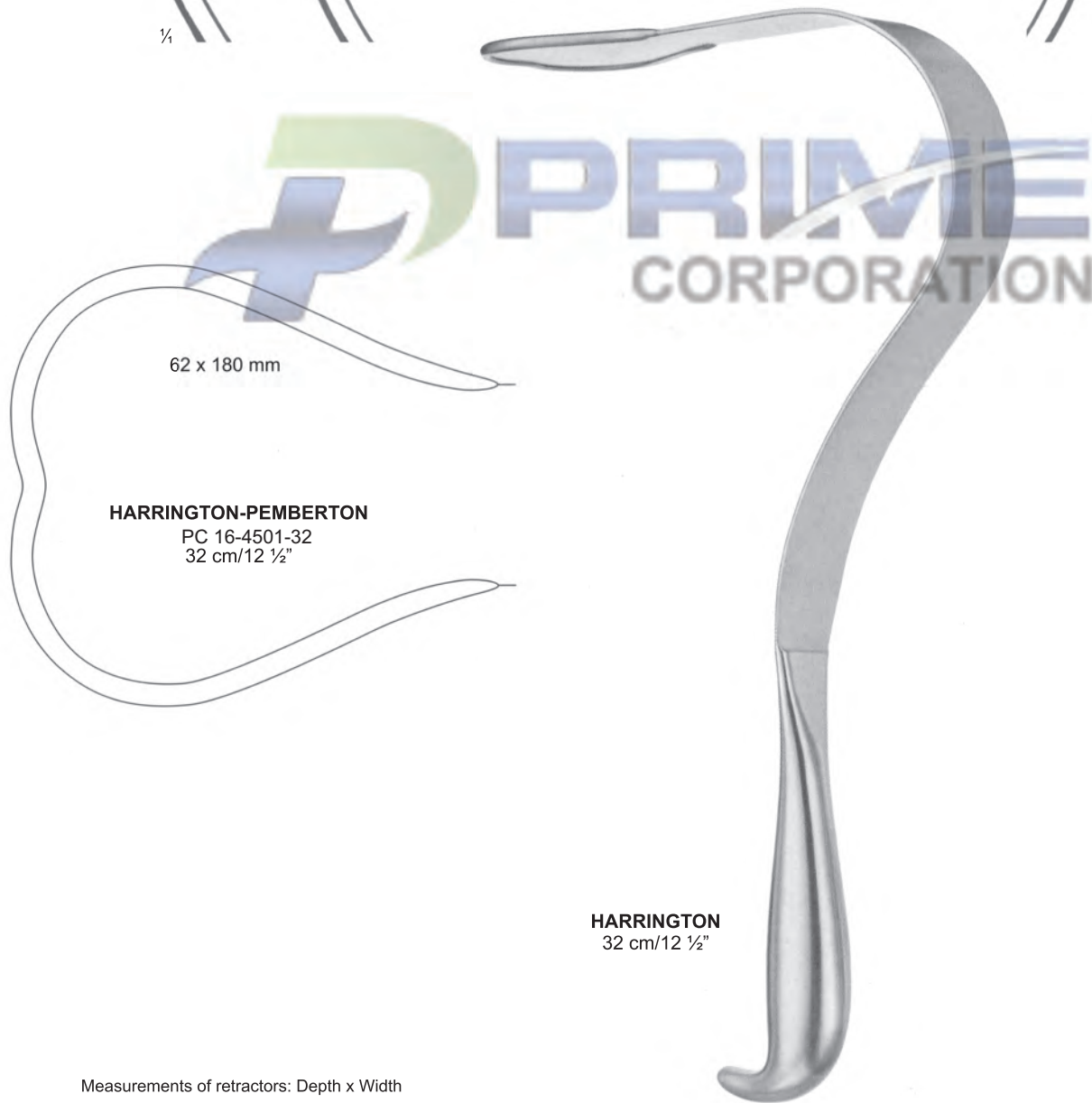
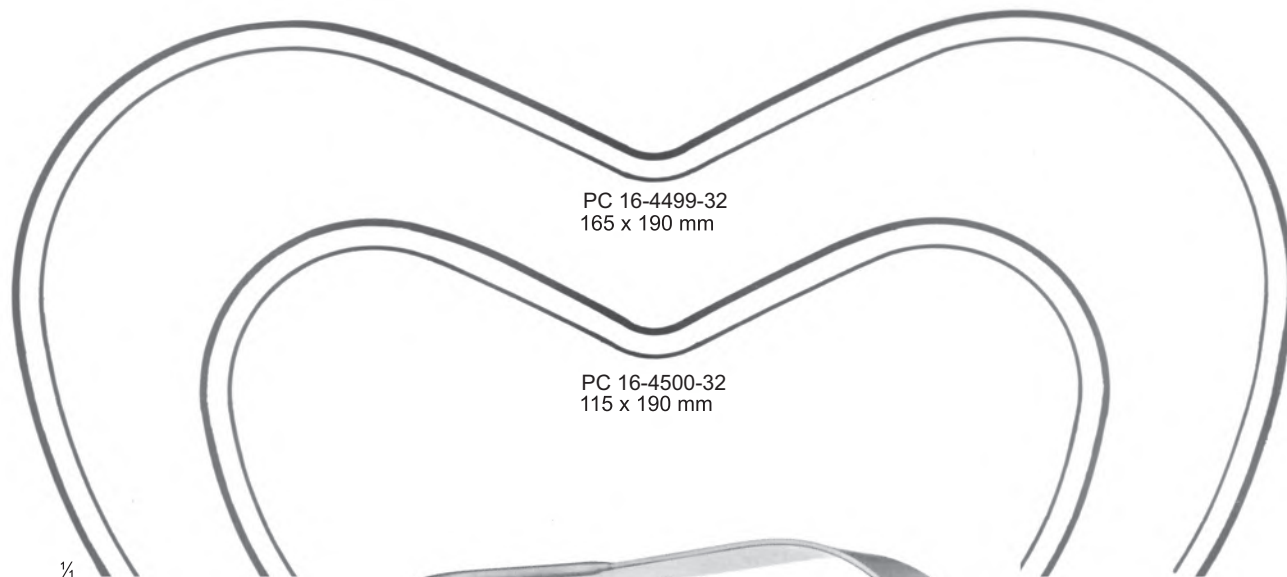

62 x 180 mm

**HARRINGTON-PEMBERTON**  
PC 16-4501-32  
32 cm/12 1/2"

**HARRINGTON**  
32 cm/12 1/2"

Measurements of retractors: Depth x Width

- Retractors ● — EN
- Wundhaken ● — DE
- Separadores ● — ES



PC 16-4502-22  
45 x 15 mm



PC 16-4503-22  
60 x 23 mm



PC 16-4504-22  
72 x 20 mm

**SAUERBRUCH**  
22.5 cm/8 3/4"

Measurements of retractors: Depth x Width

- EN —● Retractors
- DE —● Wundhaken
- ES —● Separadores





- Retractors ● EN
- Wundhaken ● DE
- Separadores ● ES



38 mm

50 mm

75 mm

**DEAVER**  
PC 16-4511-32  
32 cm/12 1/2"

**DEAVER**  
PC 16-4512-31  
31.5 cm/12 3/8"

**DEAVER**  
PC 16-4513-31  
31.5 cm/12 3/8"

- EN —● Retractors
- DE —● Wundhaken
- ES —● Separadores

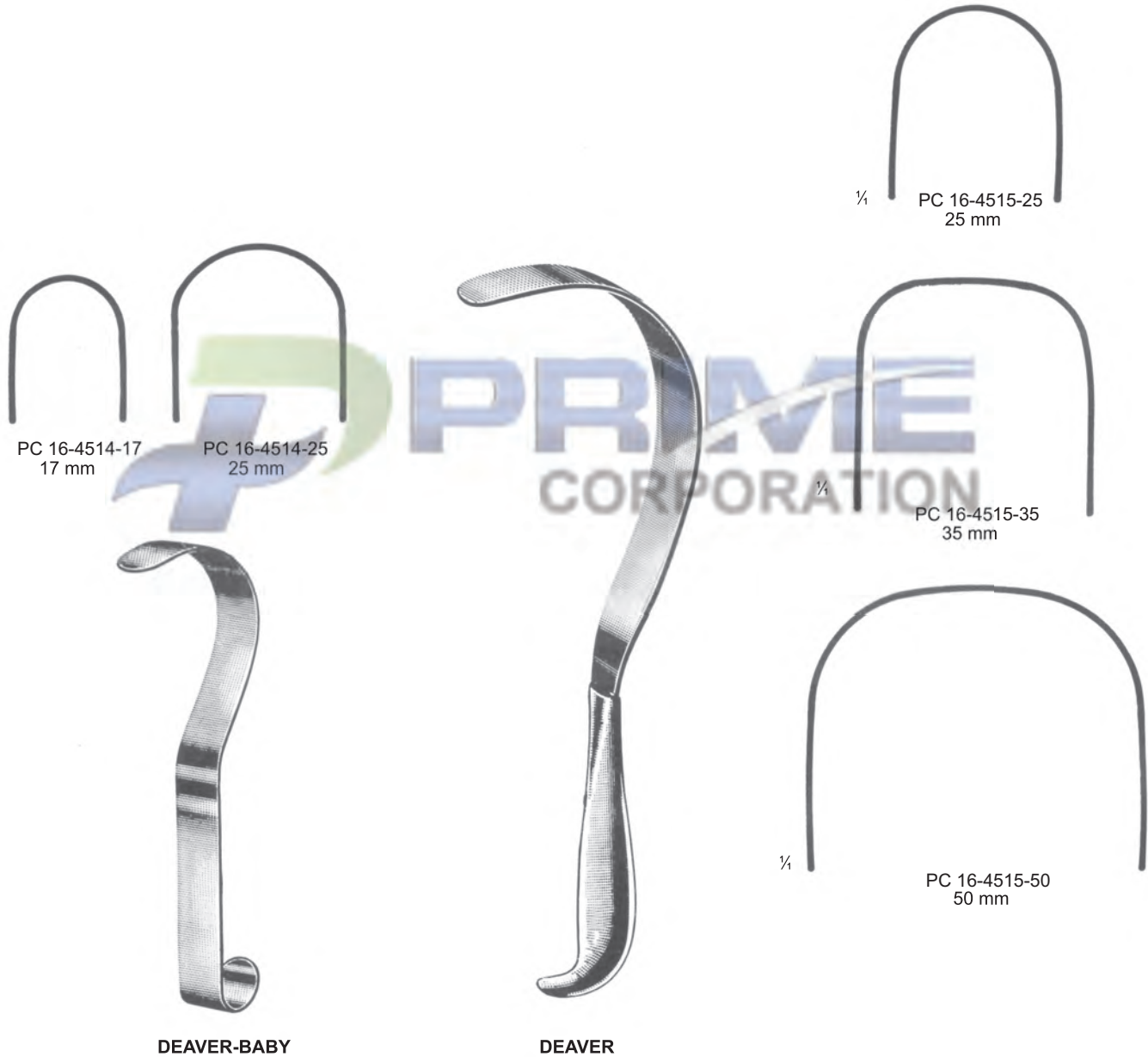

Retractors, Lung Spatulas ●— EN  
 Wundhaken, Lungenspatel ●— DE  
 Separadores, Espátulas Pulmonares ●— ES



PC 16-4516-29  
 29.5 cm/11 5/8"  
 width of blade 48 mm

PC 16-4516-33  
 33 cm/13"  
 width of blade 63 mm

ALLISON



PC 16-4517-29  
 29.5 cm/11 5/8"  
 width of blade 132 mm

ALLISON

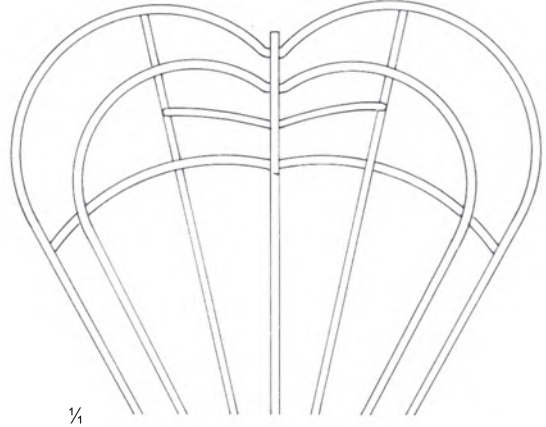

**HIBBS**  
 PC 16-4518-7575 x 25 mm  
 PC 16-4518-5050 x 19 mm  
 PC 16-4518-2525 x 13 mm

Measurements of retractors: Depth x Width

- EN —● Retractors
- DE —● Wundhaken
- ES —● Separadores

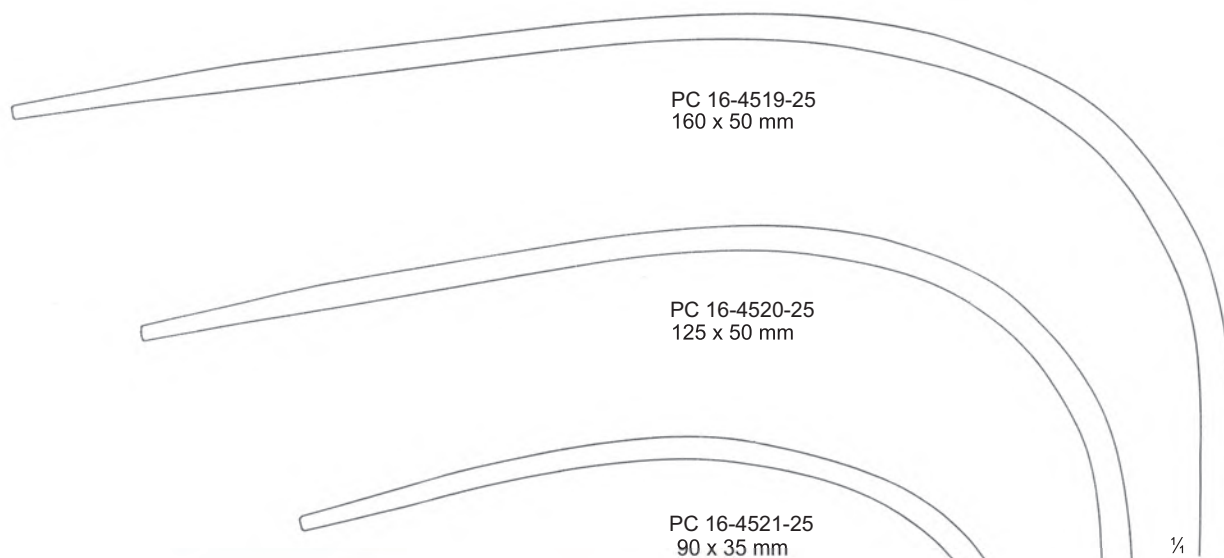

**MIKULICZ**  
25 cm/9 7/8"



- Retractors ● — EN
- Wundhaken ● — DE
- Separadores ● — ES

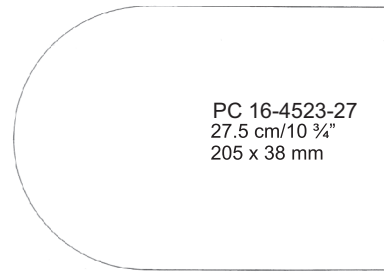
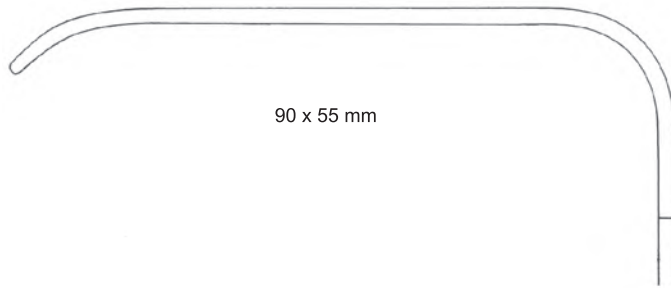

**MIKULICZ**  
PC 16-4522-26  
26 cm/10 1/4"



**KELLY**

- EN —● Spatulas
- DE —● Spatel
- ES —● Espátulas

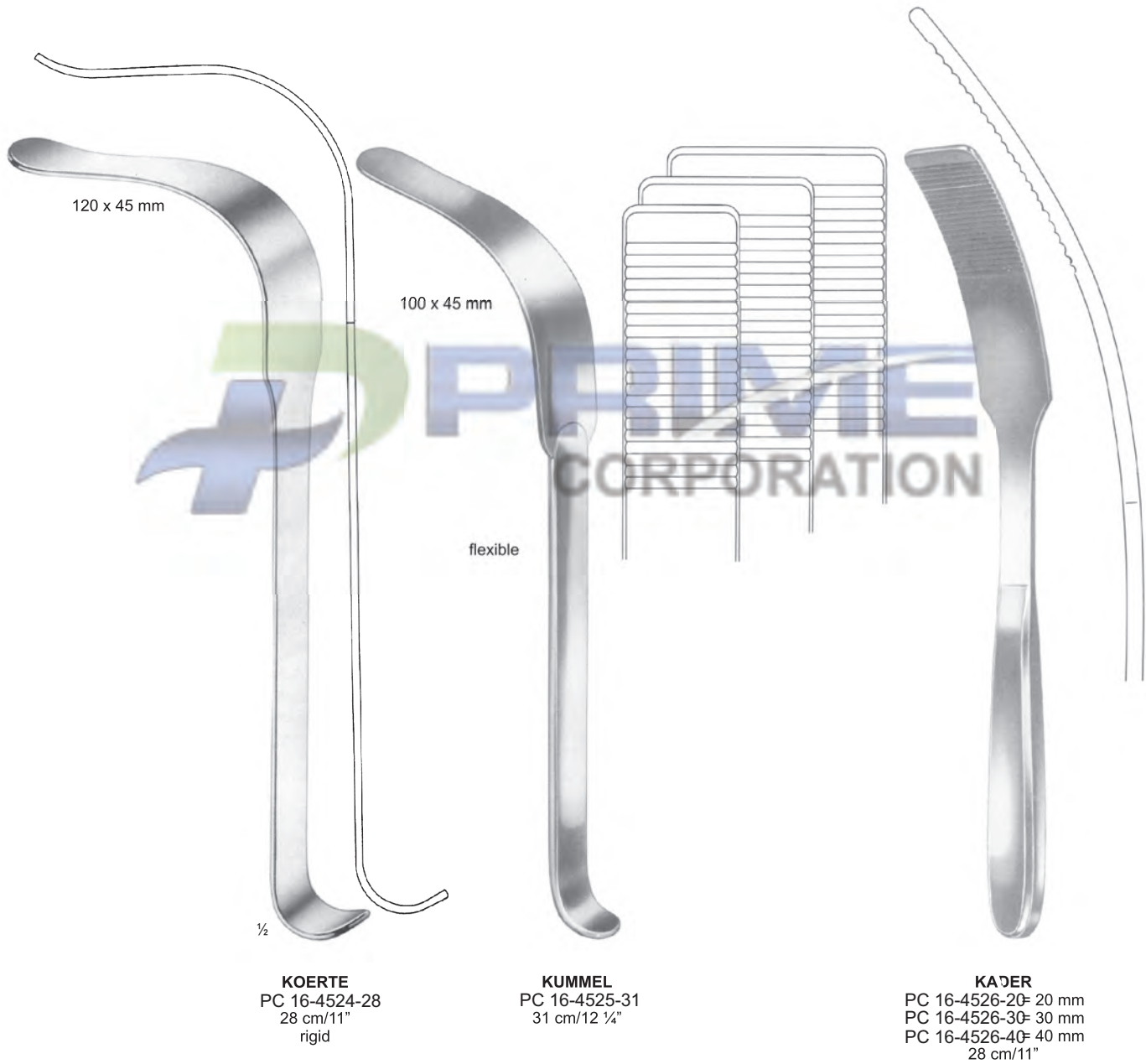

**KOERTE**  
PC 16-4524-28  
28 cm/11"  
rigid

**KUMMEL**  
PC 16-4525-31  
31 cm/12 1/4"

**KAJER**  
PC 16-4526-20= 20 mm  
PC 16-4526-30= 30 mm  
PC 16-4526-40= 40 mm  
28 cm/11"

Measurements of Spatulas : Depth x Width

- Spatulas ● — EN
- Spatel ● — DE
- Espátulas ● — ES

RIBBON SPATULAS



**TUFFIER**  
 20 cm/7 7/8"  
 PC 16-4527-20 17 x 25 mm  
 malleable

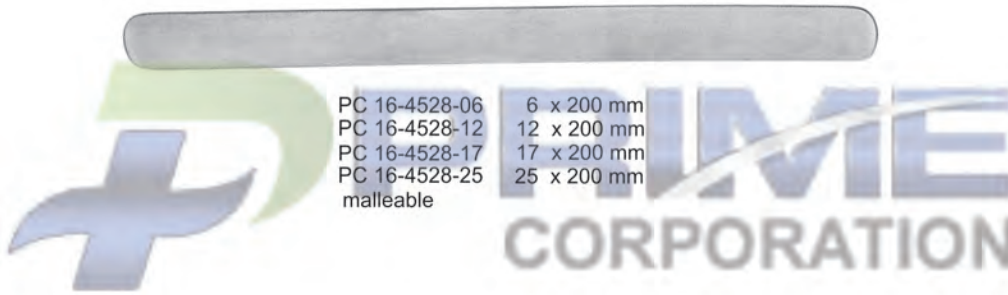

PC 16-4528-06 6 x 200 mm  
 PC 16-4528-12 12 x 200 mm  
 PC 16-4528-17 17 x 200 mm  
 PC 16-4528-25 25 x 200 mm  
 malleable



PC 16-4529-27 27 x 250 mm  
 PC 16-4529-35 35 x 250 mm  
 malleable



PC 16-4530-30 30 x 330 mm  
 PC 16-4530-40 40 x 330 mm  
 PC 16-4530-50 50 x 330 mm  
 PC 16-4530-75 75 x 330 mm  
 malleable

- EN —● Spatulas
- DE —● Spatel
- ES —● Espátulas



malleable



63 mm

**HABERER**

- PC 16-4531-20 20 cm/7 7/8" 17 x 25 mm
- PC 16-4531-28 28 cm/11" 25 x 30 mm
- PC 16-4531-30 30 cm/11 3/4" 37 x 45 mm

- PC 16-4532-20 6.5 mm
- PC 16-4533-20 9.5 mm
- PC 16-4534-20 13 mm
- PC 16-4535-20 16 mm
- PC 16-4536-20 19 mm
- PC 16-4537-20 25 mm

45 mm

**REVERDIN**

- PC 16-4538-28 28.5 cm/11 1/4"
- 63 x 45 mm



45 mm

60 mm

1/2

- REVERDIN**  
 PC 16-4539-29  
 29 cm/11 1/2"  
 60 x 45 mm



45 mm

60 mm

1/2

- REVERDIN**  
 PC 16-4540-28  
 28 cm/11"  
 60 x 45 mm

- Retractors ● — EN
- Wundhaken ● — DE
- Separadores ● — ES



**POLLOSON**  
PC 16-4541-29  
29 cm/11 1/2"

Measurements of retractors: Depth x width



- EN —● Retractors
- DE —● Wundhaken
- ES —● Separadores

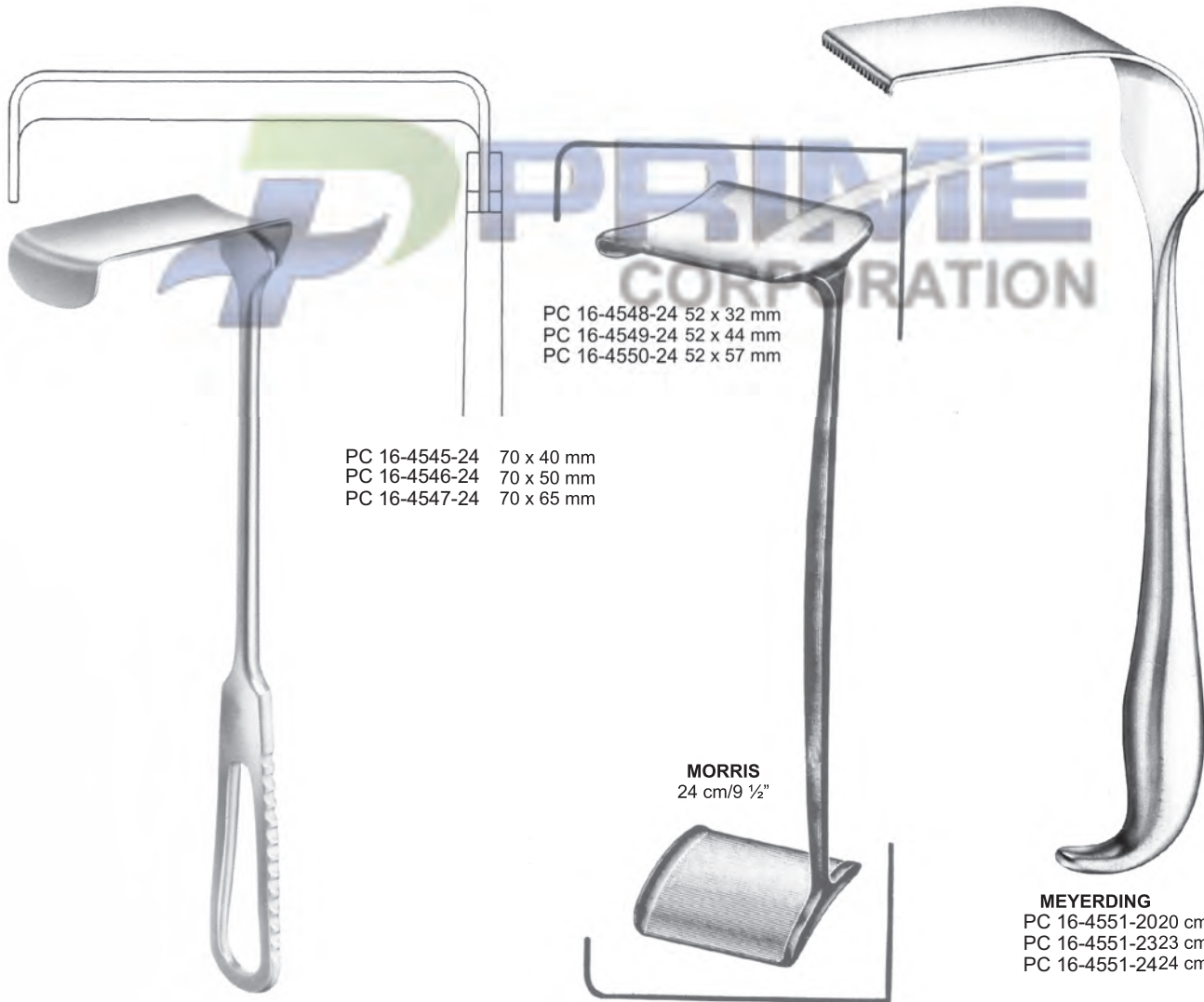
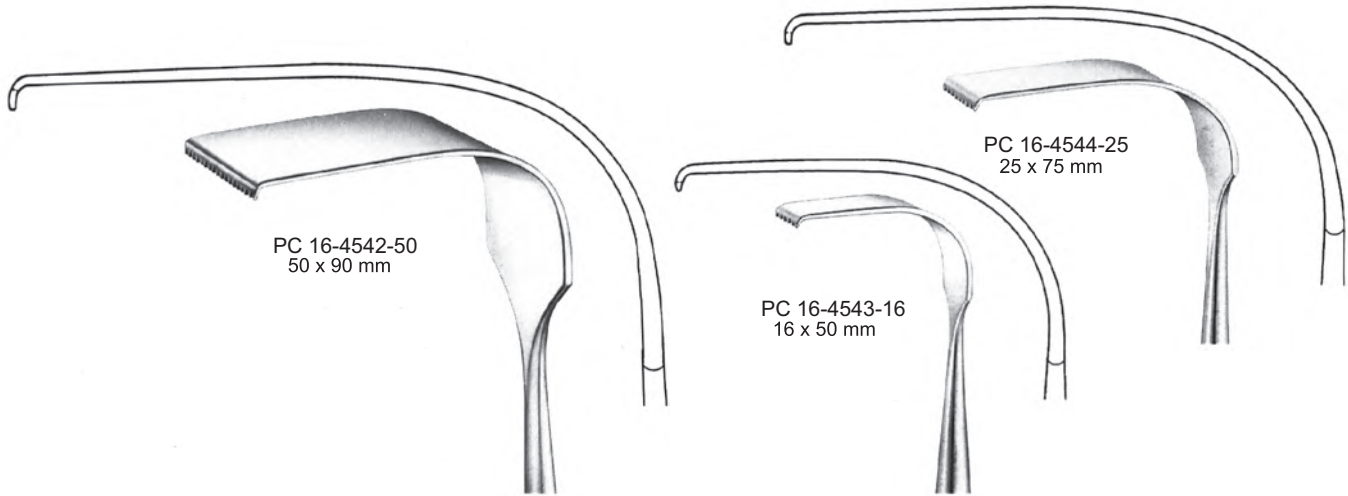

**MORRIS**  
24.5 cm/9 5/8"

**MORRIS**  
24 cm/9 1/2"

**MEYERDING**  
PC 16-4551-2020 cm/7 7/8"  
PC 16-4551-2323 cm/9"  
PC 16-4551-2424 cm/9 1/2"

Measurements of Spatulas : Depth x Width

Retractors ● EN  
 Wundhaken ● DE  
 Separadores ● ES

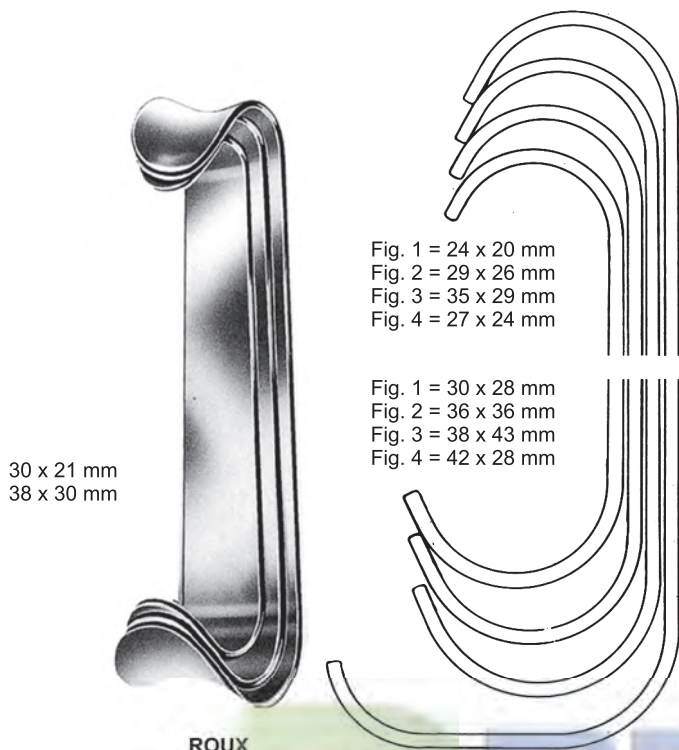

30 x 21 mm  
 38 x 30 mm

Fig. 1 = 24 x 20 mm  
 Fig. 2 = 29 x 26 mm  
 Fig. 3 = 35 x 29 mm  
 Fig. 4 = 27 x 24 mm

Fig. 1 = 30 x 28 mm  
 Fig. 2 = 36 x 36 mm  
 Fig. 3 = 38 x 43 mm  
 Fig. 4 = 42 x 28 mm

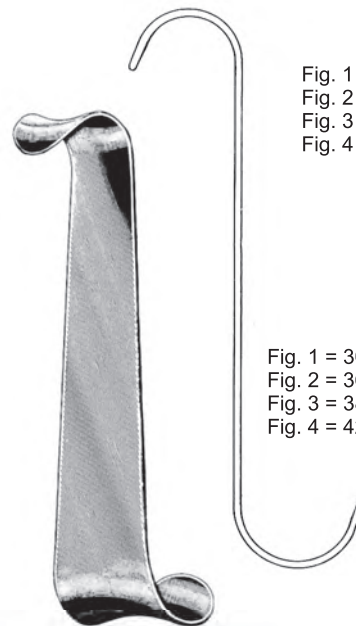

Fig. 1 = 24 x 20 mm  
 Fig. 2 = 29 x 26 mm  
 Fig. 3 = 35 x 39 mm  
 Fig. 4 = 27 x 24 mm

Fig. 1 = 30 x 28 mm  
 Fig. 2 = 36 x 36 mm  
 Fig. 3 = 38 x 43 mm  
 Fig. 4 = 42 x 28 mm

### ROUX

PC 16-4552-01 Set Fig. 1 - 3  
 PC 16-4552-14 Fig. 1 14 cm/5 1/2"  
 PC 16-4552-15 Fig. 2 15 cm/5 7/8"  
 PC 16-4552-17 Fig. 3 17 cm/6 3/4"  
 PC 16-4552-18 Fig. 4 18 cm/7 1/8"

### ROUX-MAGNUS

PC 16-4553-01 Set Fig. 1 - 3  
 PC 16-4553-14 Fig. 1 14 cm/5 1/2"  
 PC 16-4553-15 Fig. 2 15 cm/5 7/8"  
 PC 16-4553-17 Fig. 3 17 cm/6 3/4"  
 PC 16-4553-18 Fig. 4 18 cm/7 1/8"

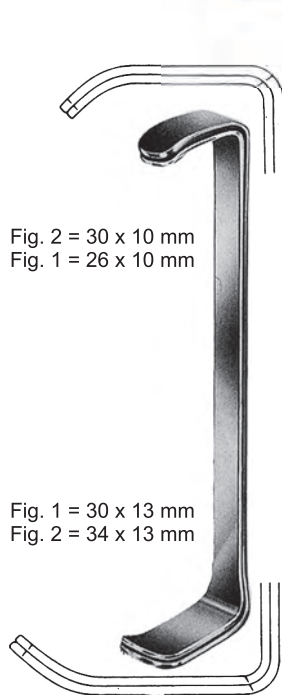

Fig. 2 = 30 x 10 mm  
 Fig. 1 = 26 x 10 mm

Fig. 1 = 30 x 13 mm  
 Fig. 2 = 34 x 13 mm

### FARABEU

PC 16-4554-11Set  
 PC 16-4555-11Fig. 1  
 PC 16-4556-11Fig. 2  
 11.5 cm/4 1/2"

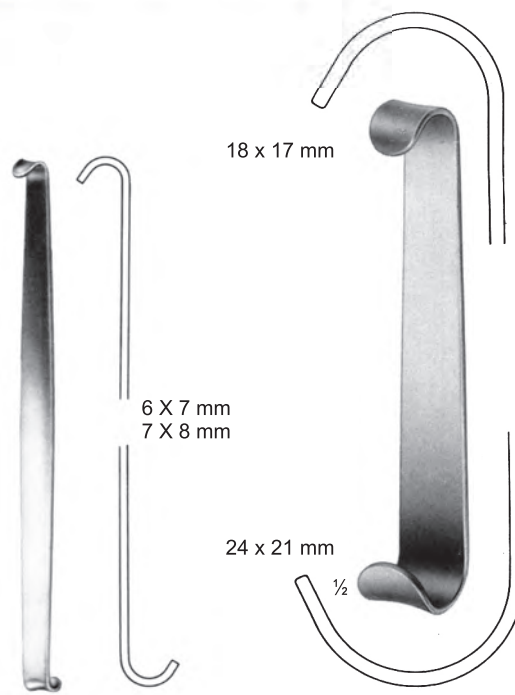

Fig. 2 = 27 x 16 mm  
 Fig. 1 = 23 x 16 mm

Fig. 1 = 26 x 16 mm  
 Fig. 2 = 30 x 16 mm

### FARABEU

PC 16-4557-15Set  
 PC 16-4558-15Fig. 1  
 PC 16-4559-15Fig. 2  
 15 cm/5 7/8"



18 x 17 mm

6 X 7 mm  
 7 X 8 mm

24 x 21 mm

### MINI-ROUX

PC 16-4560-14  
 14 cm/5 1/2"

### BABY ROUX

PC 16-4561-13  
 13 cm/5 1/8"

- EN —●— Retractors
- DE —●— Wundhaken
- ES —●— Separadores

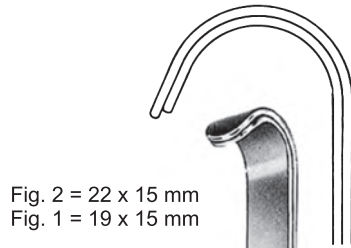

Fig. 2 = 22 x 15 mm  
Fig. 1 = 19 x 15 mm

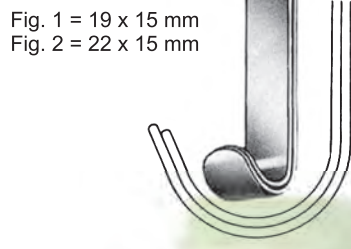

Fig. 1 = 19 x 15 mm  
Fig. 2 = 22 x 15 mm

**PARKER**  
PC 16-4562-13 Set  
PC 16-4563-13 Fig. 1  
PC 16-4564-13 Fig. 2  
13.5 cm/5 3/8"

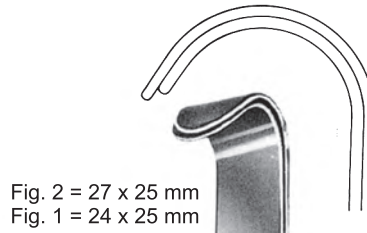

Fig. 2 = 27 x 25 mm  
Fig. 1 = 24 x 25 mm

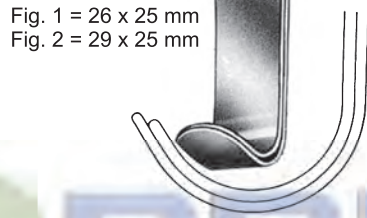

Fig. 1 = 26 x 25 mm  
Fig. 2 = 29 x 25 mm

**PARKER**  
PC 16-4565-18 Set  
PC 16-4566-18 Fig. 1  
PC 16-4567-18 Fig. 2  
18 cm/7 1/8"



Fig. 2 = 25 x 24 mm  
Fig. 1 = 21 x 24 mm

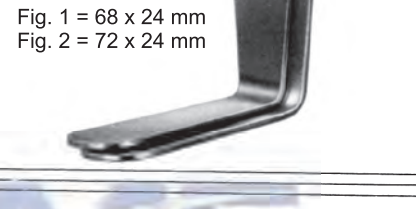

Fig. 1 = 68 x 24 mm  
Fig. 2 = 72 x 24 mm

**PARKER-MOTT**  
PC 16-4568-16 Set  
PC 16-4569-16 Fig. 1  
PC 16-4570-16 Fig. 2  
16 cm/6 1/4"

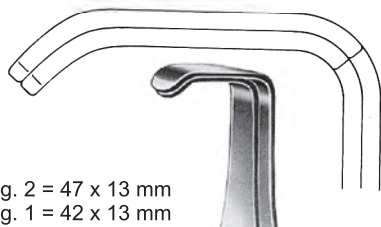

Fig. 2 = 47 x 13 mm  
Fig. 1 = 42 x 13 mm

**MATHIEU**  
PC 16-4571-20 Set  
PC 16-4572-20 Fig. 1  
PC 16-4573-20 Fig. 2  
20 cm/7 7/8"

Fig. 1 = 42 x 26 mm  
Fig. 2 = 46 x 26 mm

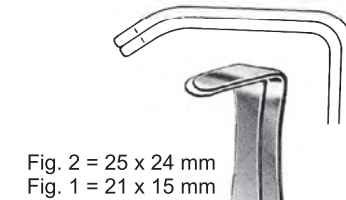
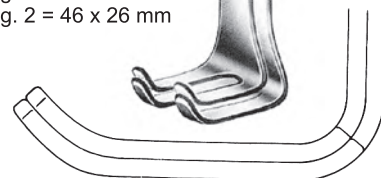
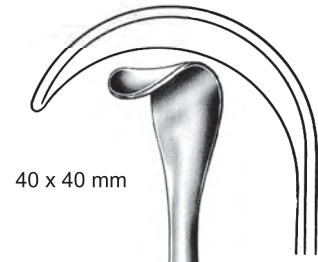

Fig. 2 = 25 x 24 mm  
Fig. 1 = 21 x 15 mm

**PARKER-LANGENBECK**  
PC 16-4574-21 Set  
PC 16-4575-21 Fig. 1  
PC 16-4576-21 Fig. 2  
21 cm/8 1/4"

Fig. 1 = 40 x 15 mm  
Fig. 2 = 45 x 15 mm



40 x 40 mm

**GOELET**  
PC 16-4577-19  
19 cm/7 1/2"

30 x 30 mm

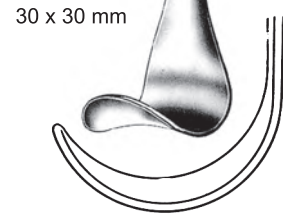



Retractors ●— EN  
 Wundhaken ●— DE  
 Separadores ●— ES

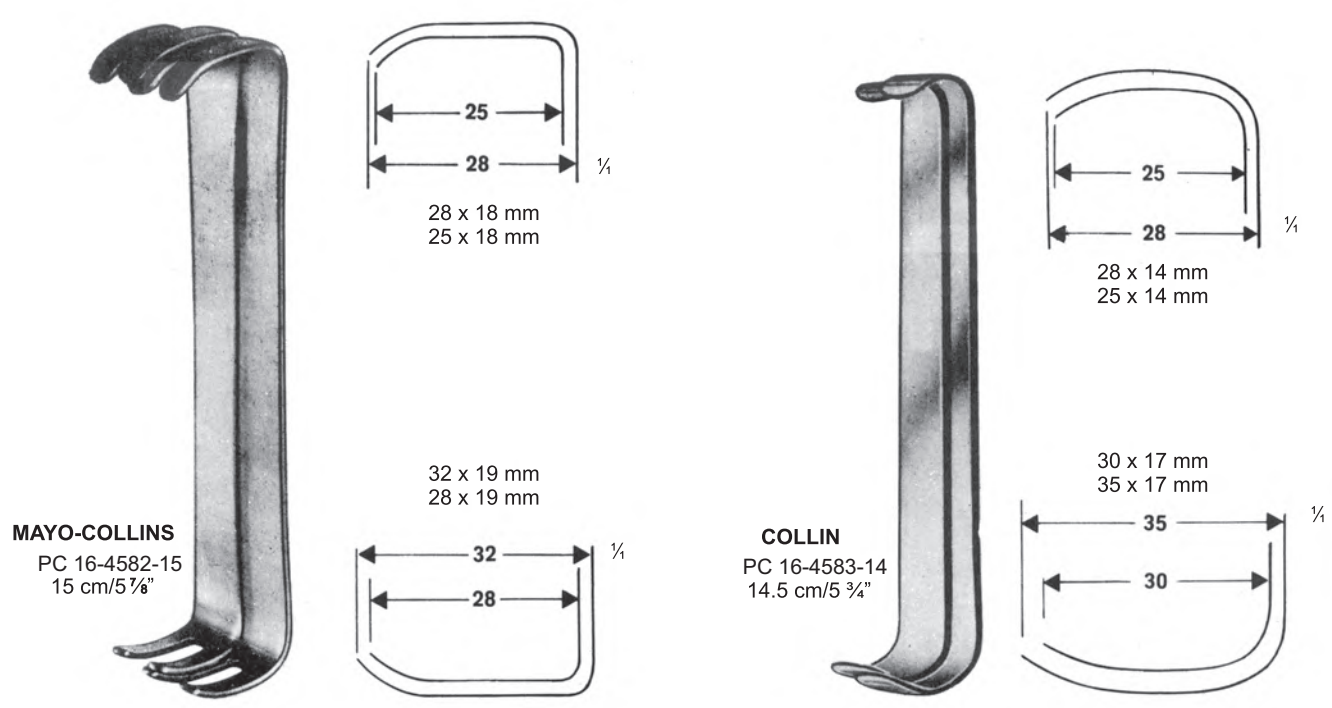

EN —● Self-Retaining Retractors  
 DE —● Wundspreizer  
 ES —● Separadores autoestáticos

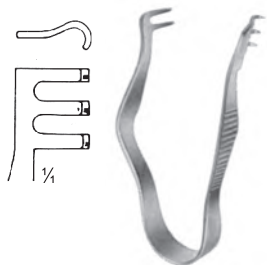

**FINSEN**  
 5 cm/2"  
 PC 16-4584-05  
 PC 16-4585-05  
 spreading 16 mm

Sharp  
 Blunt

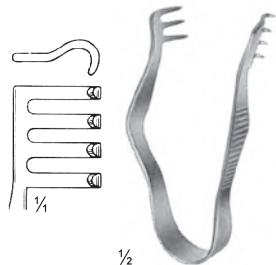

**FINSEN**  
 7 cm/2 3/4"  
 PC 16-4586-07  
 PC 16-4587-07  
 spreading 20 mm

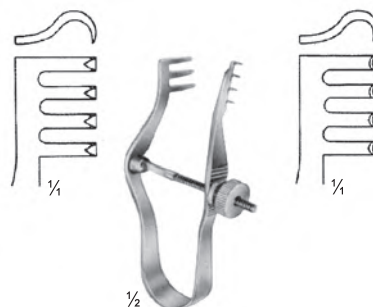

**FINSEN**  
 7 cm/2 3/4"  
 sharp PC 16-4588-07  
 blunt PC 16-4589-007  
 spreading 30 mm

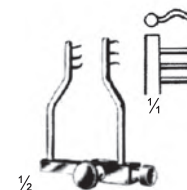

**LOGAN**  
 4 cm/1 5/8"  
 PC 16-4590-04  
 sharp  
 spreading 16 mm



**BUCKLEY**  
 PC 16-4591-06  
 6 cm/2 1/4"  
 sharp



**FINSEN**  
 PC 16-4592-08  
 8 cm/3 1/4"



Sharp PC 16-4593-7  
 Blunt PC 16-4594-07  
 PC 16-4593-10 PC 16-4594-10  
 10 cm/3 7/8"

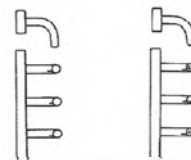

Semi Sharp  
 PC 16-4595-14  
 10 cm/3 7/8"



**HOLZHEIMER**  
 10 cm/3 7/8"



Blunt  
 PC 16-4596-10

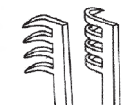

Sharp  
 PC 16-4597-10



**JANSEN**  
 10 cm/3 7/8"

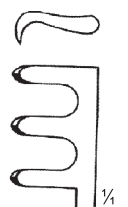

PC 16-4598-10  
 Sharp

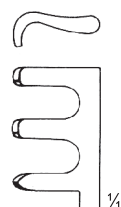

PC 16-4599-10  
 with 1 sharp and 2 blunt prongs each

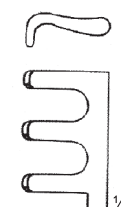

PC 16-4600-10  
 Blunt

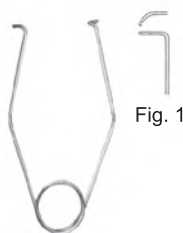

PC 16-4601-01

Fig. 1

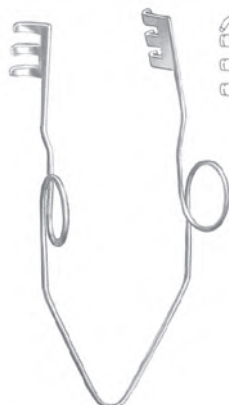

PC 16-4602-03

Fig. 3  
 3 x 3



PC 16-4603-02

Fig. 2  
 3 x 3



Retractors — EN  
 Wundhaken — DE  
 Separadores — ES



**WEITLANER**  
 2 : 2  
 PC 16-4604-13sharp  
 PC 16-4605-13blunt  
 13.5 cm/5 3/8"



**WEITLANER**  
 2 : 2  
 PC 16-4606-13semi sharp  
 13.5 cm/5 3/8"



**WEITLANER**  
 2 : 3  
 PC 16-4607-10sharp  
 PC 16-4608-10blunt  
 10.5 cm/4 1/8"

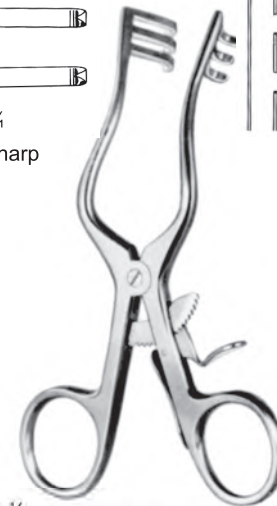
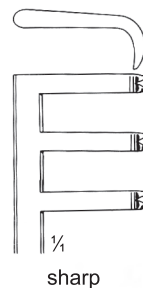

**WEITLANER**  
 3 : 4  
 PC 16-4609-1313 cm/5 1/8" sharp  
 PC 16-4610-1313 cm/5 1/8" blunt  
 PC 16-4611-1616.5 cm/6 1/2" sharp  
 PC 16-4612-1616.5 cm/6 1/2" blunt

**WEITLANER-WULLSTEIN**  
 3 : 3  
 PC 16-4613-13sharp  
 PC 16-4614-13blunt  
 13 cm/5 1/8"

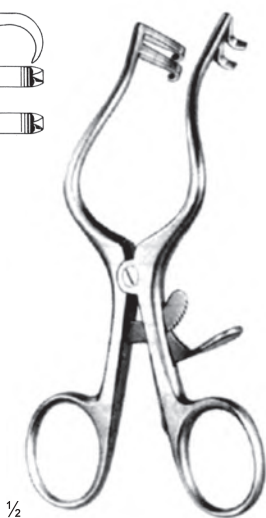
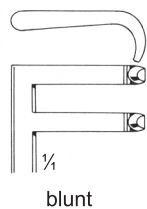
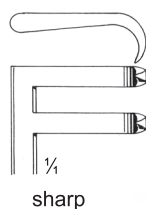

**PLESTER**  
 PC 16-4615-13sharp  
 PC 16-4616-13blunt  
 13 cm/5 1/8"

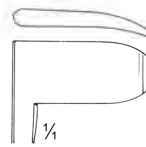
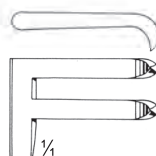

**PLESTER**  
 Blunt  
 PC 16-4617-10  
 10.5 cm/4 1/8"



**PLESTER**  
 Blunt  
 PC 16-4618-10  
 10.5 cm/4 1/8"

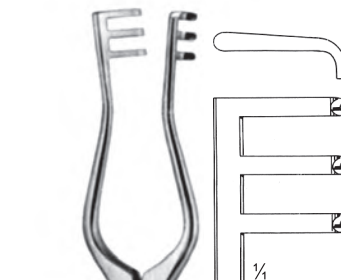

**MILLIGAN**  
 Blunt  
 PC 16-4619-13  
 13.5 cm/5 3/8"

Measurements of Retractors : Depth x Width

- EN —● Retractors
- DE —● Wundhaken
- ES —● Separadores

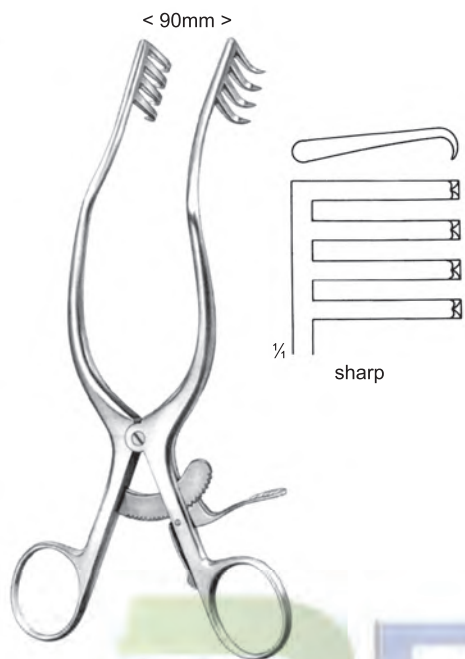

**ANDERSON - ADSON**  
4 : 4  
PC 16-4620-19  
19 cm / 7 1/2"

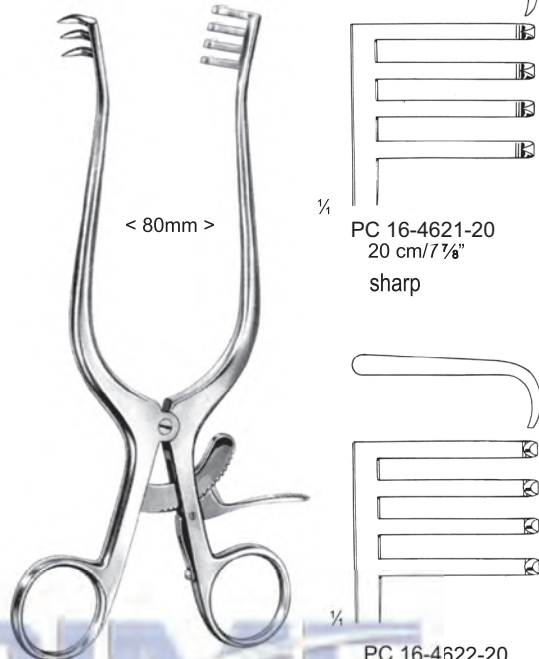

**WEITLANER**  
3 : 4

PC 16-4621-20  
20 cm / 7 7/8"  
sharp

PC 16-4622-20  
20 cm / 7 7/8"  
blunt

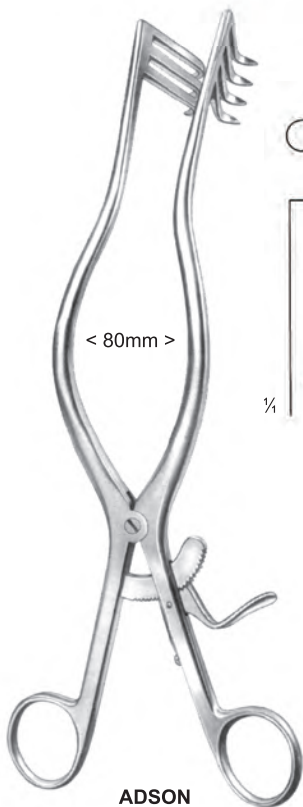

**ADSON**

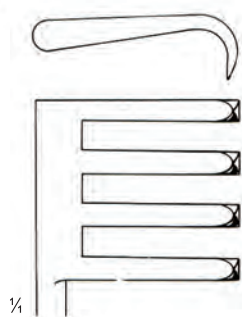

sharp  
3 : 4 teeth  
PC 16-4623-26  
26 cm / 10 1/4"

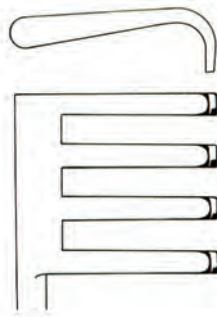

blunt  
3 : 4 teeth  
PC 16-4624-26  
26 cm / 10 1/4"

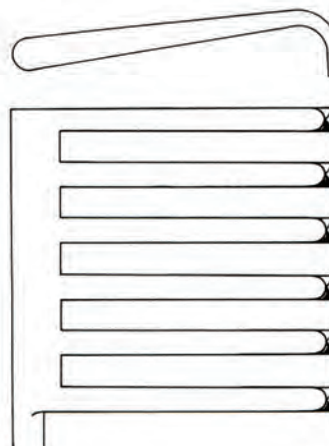

sharp  
6 : 6 teeth  
PC 16-4625-29  
29 cm / 11 1/2"

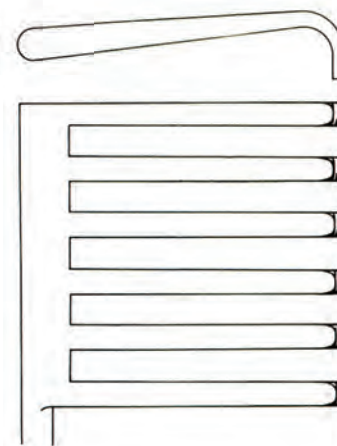

blunt  
6 : 6 teeth  
PC 16-4626-29  
29 cm / 11 1/2"

Retractors ●— EN  
 Wundhaken ●— DE  
 Separadores ●— ES



**WEITLANER-BABY**  
 PC 16-4627-13  
 13.5 cm/5 3/8"

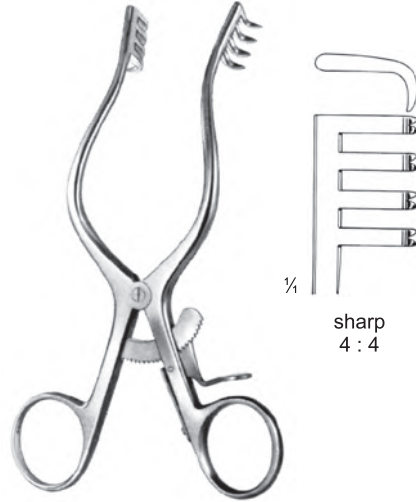

**MOLLISON**  
 PC 16-4628-15  
 15.5 cm/6 1/8"

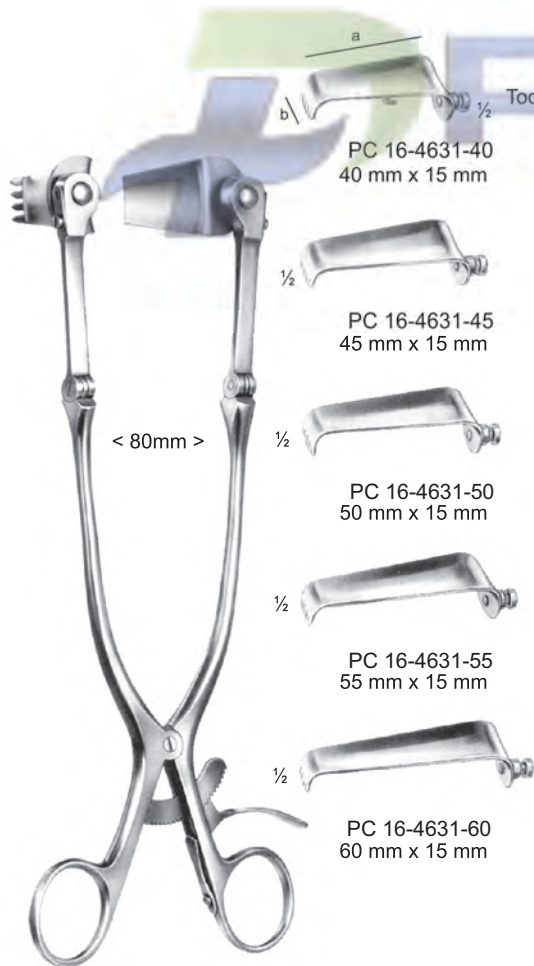

**CLOWARD**  
 PC 16-4629-25- Retractor complete (with 2 blades ea.)  
 PC 16-4630-25- Retractor only  
 25 cm/9 7/8"

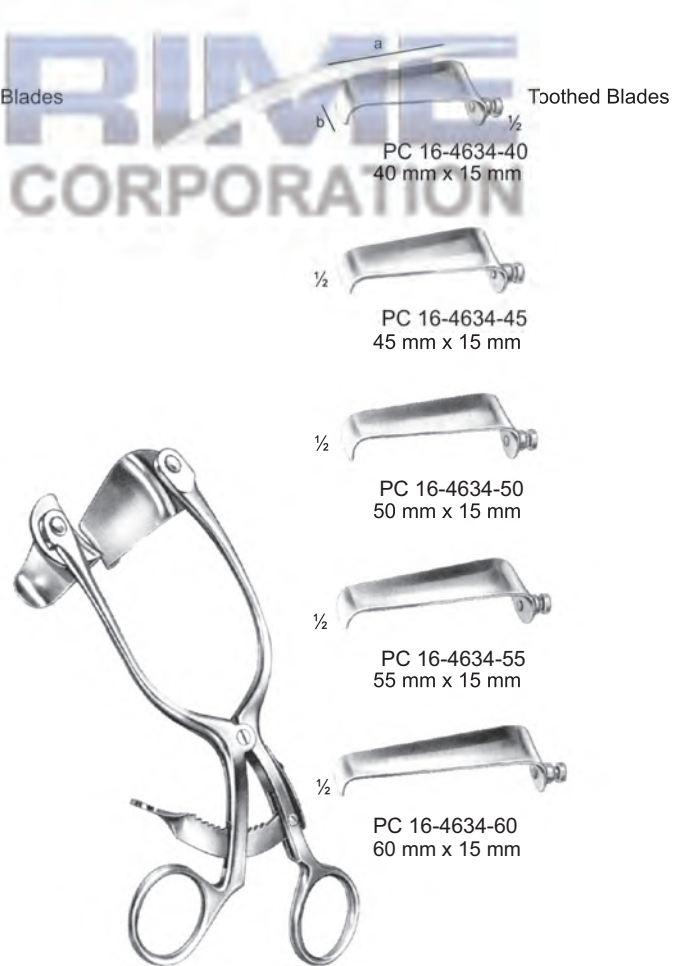

**CLOWARD**  
 PC 16-4632-16- Retractor complete (with 2 blades ea.)  
 PC 16-4633-16- Retractor only  
 16 cm/6 1/4"

- EN —● Retractors
- DE —● Wundhaken
- ES —● Separadores

sharp

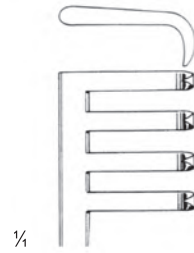

PC 16-4635-13  
13.5 cm/5 3/8"  
3 : 4



PC 16-4636-13  
13.5 cm/5 3/8"  
3 : 4

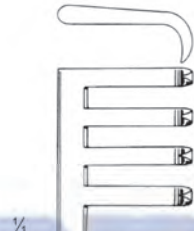

PC 16-4637-16  
16.5 cm/6 1/2"  
3 : 4

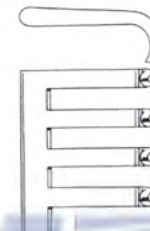

PC 16-4638-16  
16.5 cm/6 1/2"  
3 : 4



PC 16-4639-21  
21 cm/8 1/4"  
3 : 4



PC 16-4640-21  
21 cm/8 1/4"  
3 : 4

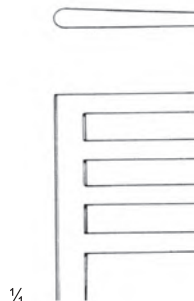

PC 16-4641-24  
24.5 cm/9 5/8"  
3 : 4



PC 16-4642-24  
24.5 cm/9 5/8"  
3 : 4



**ADSON**



Retractors ● EN  
 Wundhaken ● DE  
 Separadores ● ES

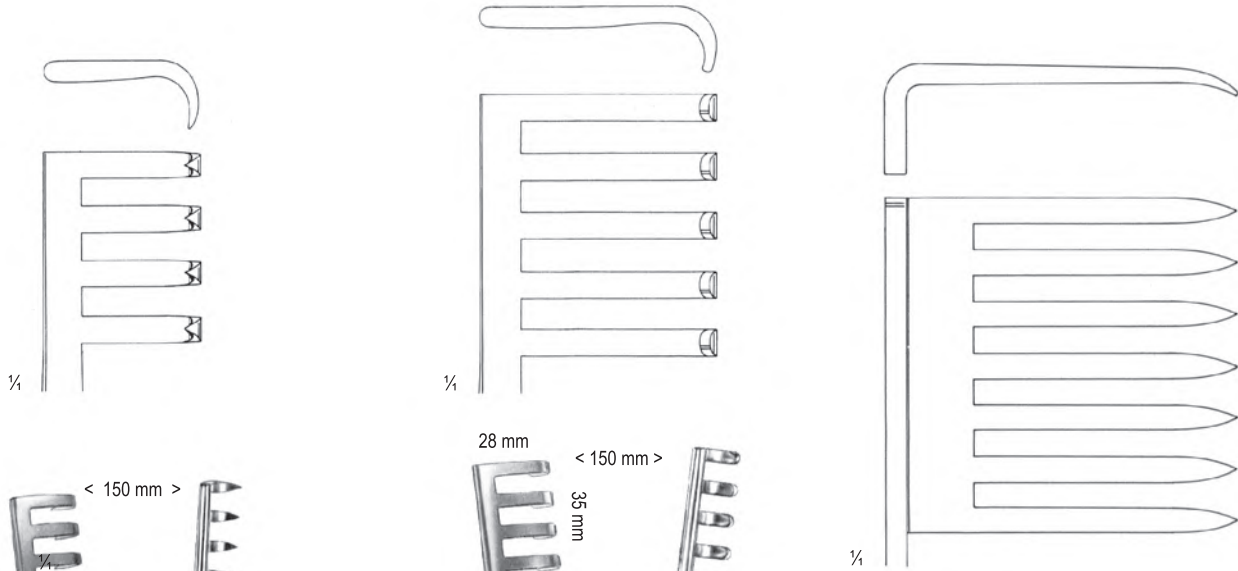

**BECKMANN**  
 PC 16-4643-31  
 31 cm/12 ¼"  
 4 : 4  
 sharp



**ADSON**  
 PC 16-4644-32  
 32 cm/12 ½"  
 4 : 5  
 blunt



**BECKMANN-EATON**  
 PC 16-4645-32  
 32 cm/12 ½"  
 7 : 7  
 Sharp

Measurements of retractors: Depth x Width



- EN —● Retractors
- DE —● Wundhaken
- ES —● Separadores

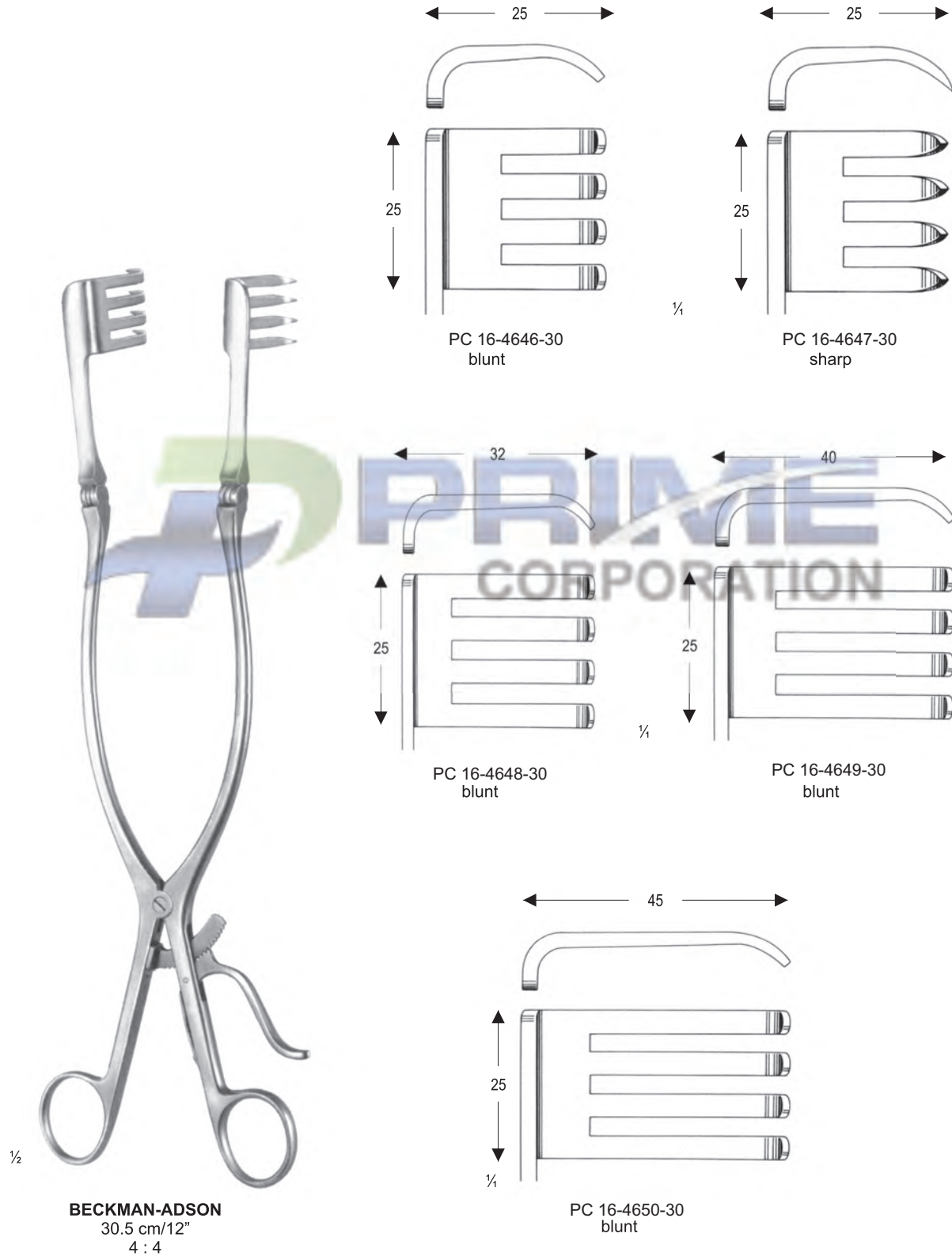

1/2

**BECKMAN-ADSON**  
30.5 cm/12"  
4 : 4

1/4

**PC 16-4650-30**  
blunt

- Retractors ● — EN
- Wundhaken ● — DE
- Separadores ● — ES

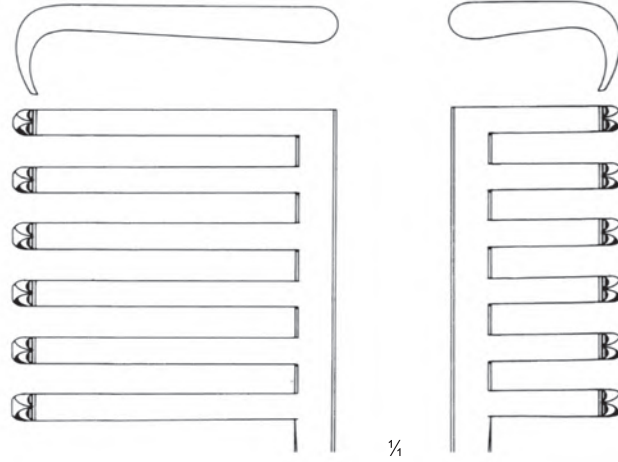

PC 16-4651-28  
Sharp, long teeth on left side



28.5 cm/11 1/4"  
6 : 6

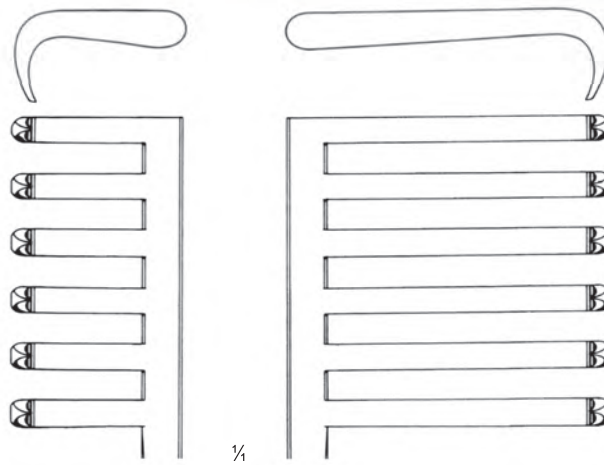

PC 16-4652-28  
Sharp, long teeth on right side

- EN —● Retractors
- DE —● Wundhaken
- ES —● Separadores

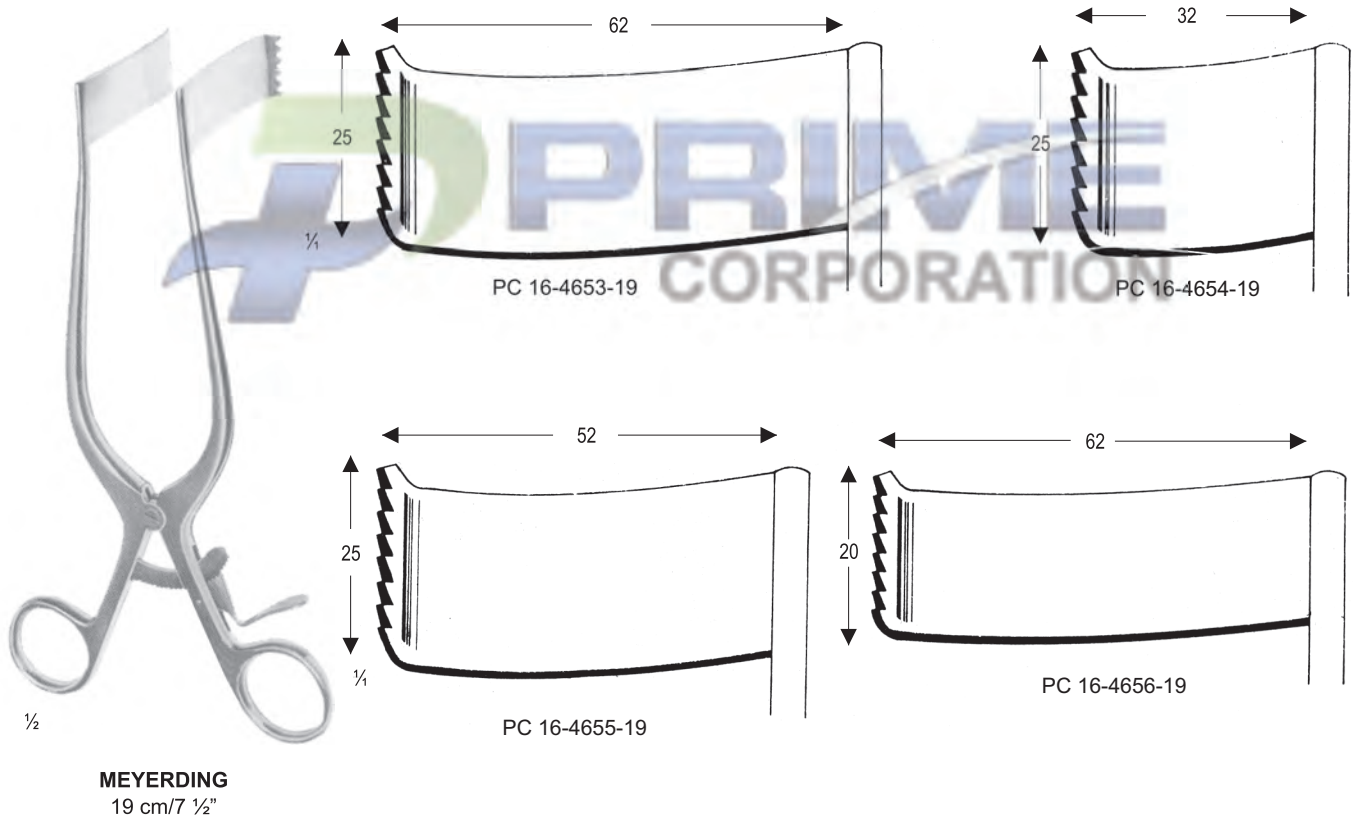

Measurements of retractors: Depth x Width

Retractors ●— EN  
 Wundhaken ●— DE  
 Separadores ●— ES

Lateral Blade  
25 x 50 mm



½

**MARKHAM-MEYERDING**  
 PC 16-4657-18  
 18 cm/7 ½"

Lateral Blade  
25 x 50 mm



½

**MARKHAM-MEYERDING**  
 PC 16-4658-18  
 18 cm/7 ½"



½

**HENLEY**  
 16 cm/6 ¼"



PC 16-4659-16  
 19 x 16 mm



PC 16-4660-16  
 25 x 16 mm



PC 16-4661-16  
 32 x 16 mm

Measurements of retractors: Depth x Width



- EN —● Abdominal Retractors
- DE —● Bauchdeckenhalter
- ES —● Separadores abdominales



**GELPI**

PC 16-4662-09	9 cm/3 1/2"
PC 16-4662-11	11 cm/4 3/8"
PC 16-4662-13	13 cm/5 1/8"
PC 16-4662-14	14 cm/5 1/2"
PC 16-4662-16	16 cm/6 1/4"
PC 16-4662-18	18 cm/7 1/8"

**GELPI-LOKTITE**

PC 16-4663-09	9 cm/3 1/2"
PC 16-4663-11	11 cm/4 3/8"
PC 16-4663-13	13 cm/5 1/8"
PC 16-4663-14	14 cm/5 1/2"
PC 16-4663-16	16 cm/6 1/4"
PC 16-4663-18	18 cm/7 1/8"

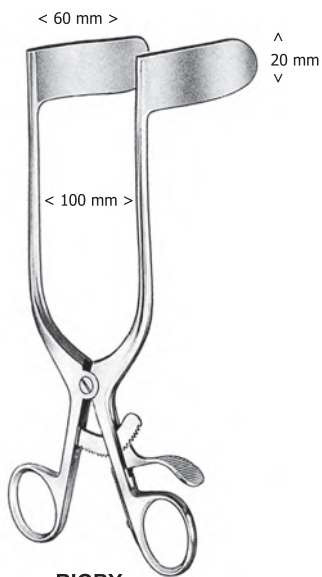

**RIGBY**  
 PC 16-4664-19  
 (Rectum, Vagina)  
 19 cm/7 1/2"

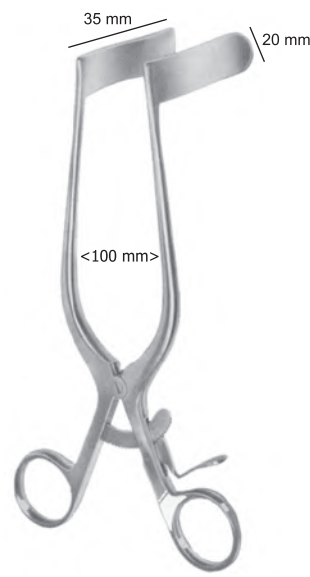

PC 16-4665-18  
 18 cm/7 1/8"

Abdominal Retractors ●— EN  
 Bauchdeckenhalter ●— DE  
 Separadores abdominales ●— ES

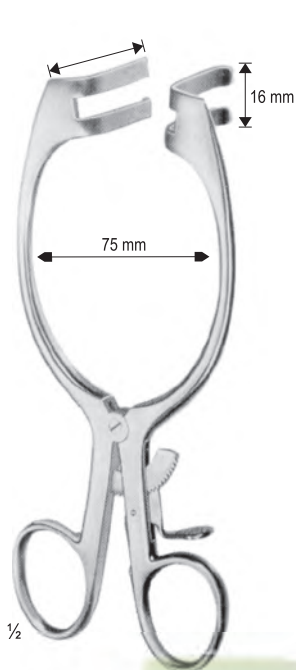

**MAYO-ADAMS**  
 PC 16-4666-16  
 16.5 cm/6 1/2"

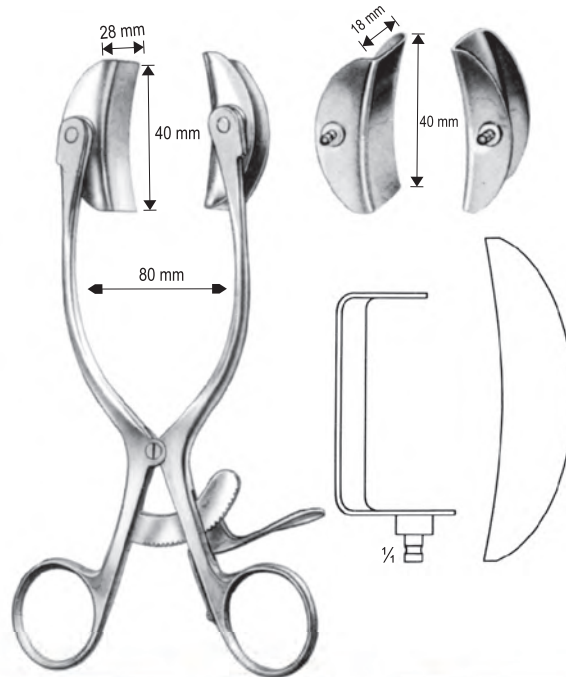

**BABY-COLLIN** complete, with 2 pairs of exchangeable blades  
 PC 16-4667-00

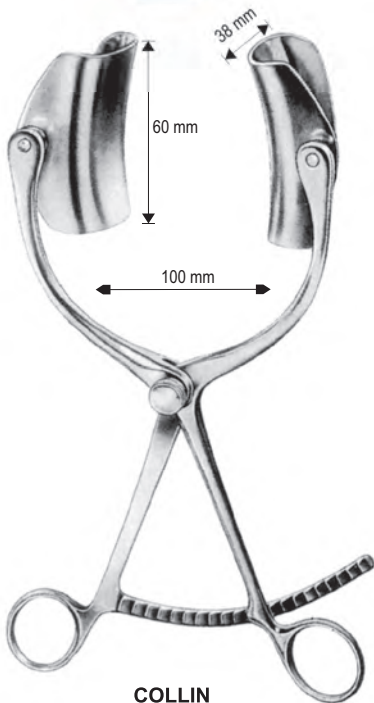

**COLLIN**  
 PC 16-4668-38



Measurements see below

**Exchangeable Blades**

<b>COLLIN</b>		Lateral Blades	Central Blades
PC 16-4669-38		38 x 60 mm	38 x 55 mm
PC 16-4670-38		38 x 80mm	50 x 75mm

Measurements of retractors: Depth x Width

- EN —● Abdominal Retractors
- DE —● Bauchdeckenhalter
- ES —● Separadores abdominales

**Exchangeable Blades**

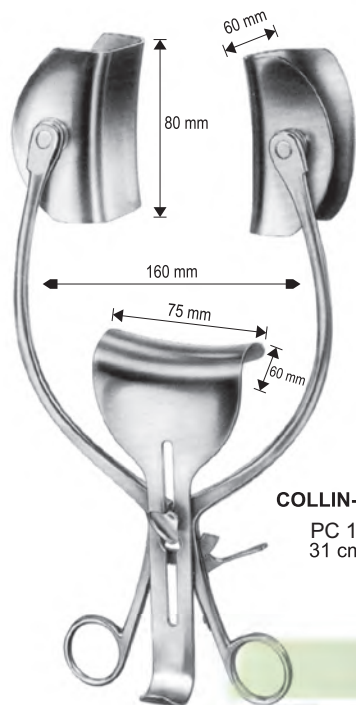

**COLLIN-LOCKTITE**  
PC 16-4671-31  
31 cm 12 1/4"

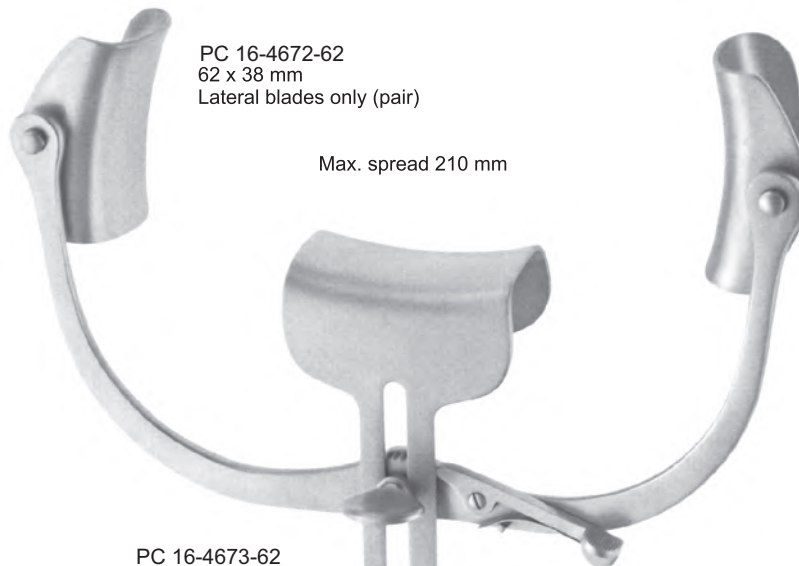

PC 16-4672-62  
62 x 38 mm  
Lateral blades only (pair)

Max. spread 210 mm

PC 16-4673-62  
Frame only

PC 16-4674-64  
64 x 40 mm  
Center blade only

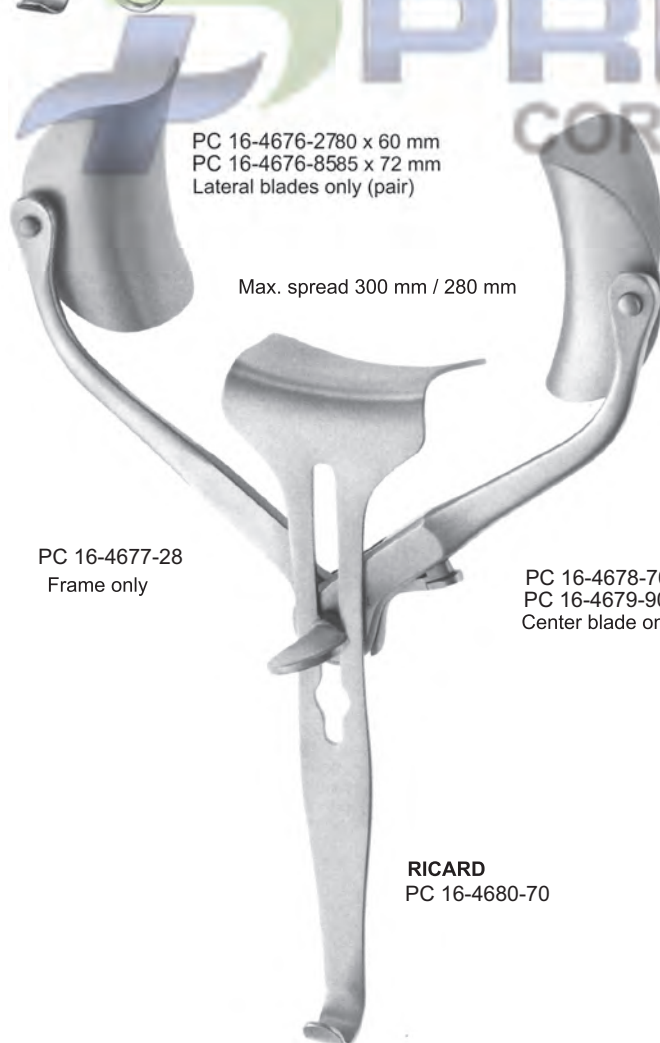

PC 16-4676-2780 x 60 mm  
PC 16-4676-8585 x 72 mm  
Lateral blades only (pair)

Max. spread 300 mm / 280 mm

PC 16-4677-28  
Frame only

PC 16-4678-7070 x 55 mm  
PC 16-4679-9090 x 80 mm  
Center blade only

**ROBIN-MASSE**  
PC 16-4675-64

**RICARD**  
PC 16-4680-70

Measurements of retractors: Depth x Width

- Abdominal Retractors ●— EN
- Bauchdeckenhalter ●— DE
- Separadores abdominales ●— ES



**BALFOUR**  
PC 16-4681-20  
20 cm/7 7/8"

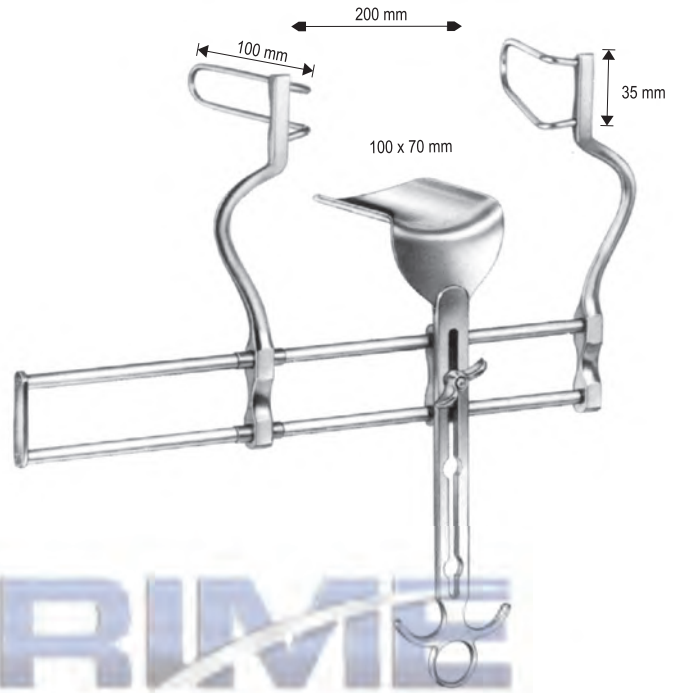

**BALFOUR**  
PC 16-4682-20

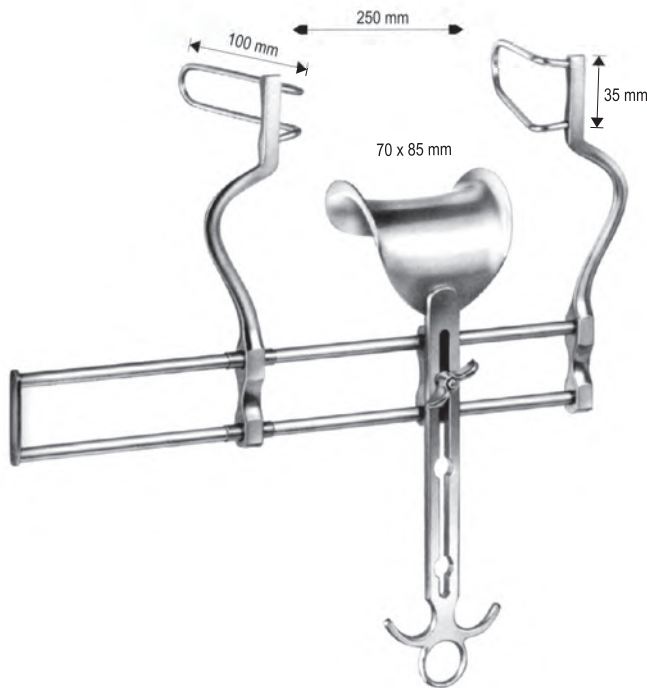

**BALFOUR**  
PC 16-4683-00

Centre Blade only



**BALFOUR**  
PC 16-4684-45= 45 X 80 mm  
PC 16-4684-70= 70 X 85 mm  
PC 16-4684-80= 80 X 90 mm

Measurements of retractors: Depth x Width



- EN —● Abdominal Retractors
- DE —● Bauchdeckenhalter
- ES —● Separadores abdominales

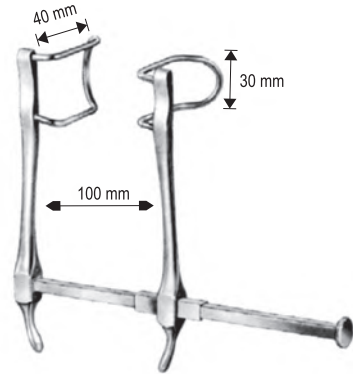

**GOSSET-BABY**  
OI 16-4685-12  
12.5 cm/4 7/8"

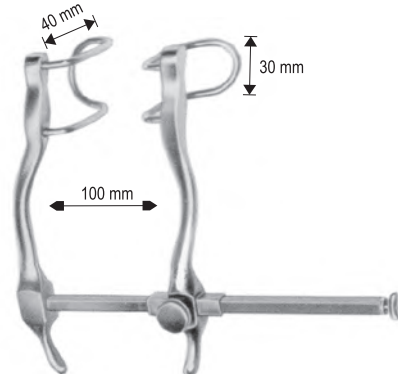

**GOSSET**  
OI 16-4686-12



**GOSSET**  
OI 16-4687-16  
16.5 cm/6 1/2"

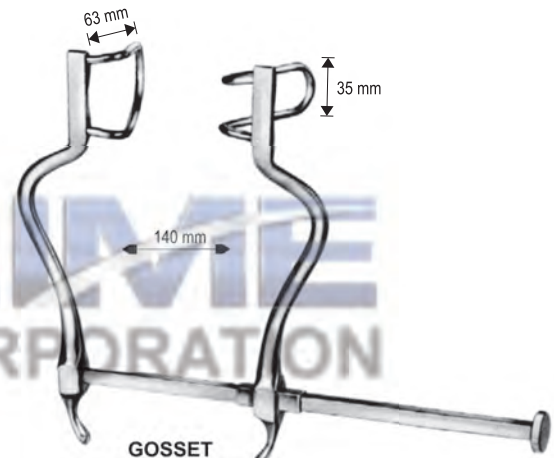

**GOSSET**  
OI 16-4688-18  
18.5cm/7 1/4"

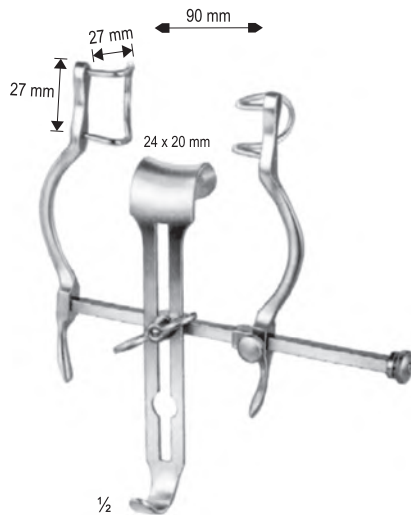

**BALFOUR-BABY**  
OI 16-4689-12  
12.5cm/4 7/8"

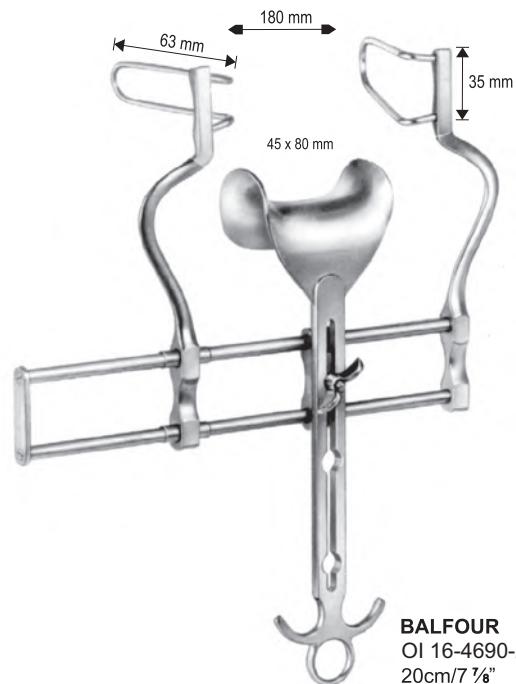

**BALFOUR**  
OI 16-4690-20  
20cm/7 7/8"

Measurements of retractors: Depth x Width



Abdominal Retractors ●— EN  
 Bauchdeckenhalter ●— DE  
 Separadores abdominales ●— ES

OI 16-4691-50 50 x 98 mm

OI 16-4693-35 35 x 105 mm

OI 16-4692-94 94 x 83 mm

OI 16-4694-57 57 x 45 mm

OI 16-4695-57 57 x 45 mm

**SEMM**

- OI 16-4648-57
- Complete
- 1 x OI 16-4698-57
- 2 x OI 16-4699-57
- 1 x OI 16-4700-57
- 1 x OI 16-4701-57
- 1 x OI 16-4702-57
- 1 x OI 16-4703-57

OI 16-4696-25  
 275 x 250 mm  
 Frame only

OI 16-4697-54 54 x 50 mm

Measurements of retractors: Depth x Width

- EN — Abdominal Retractors
- DE — Bauchdeckenhalter
- ES — Separadores abdominales

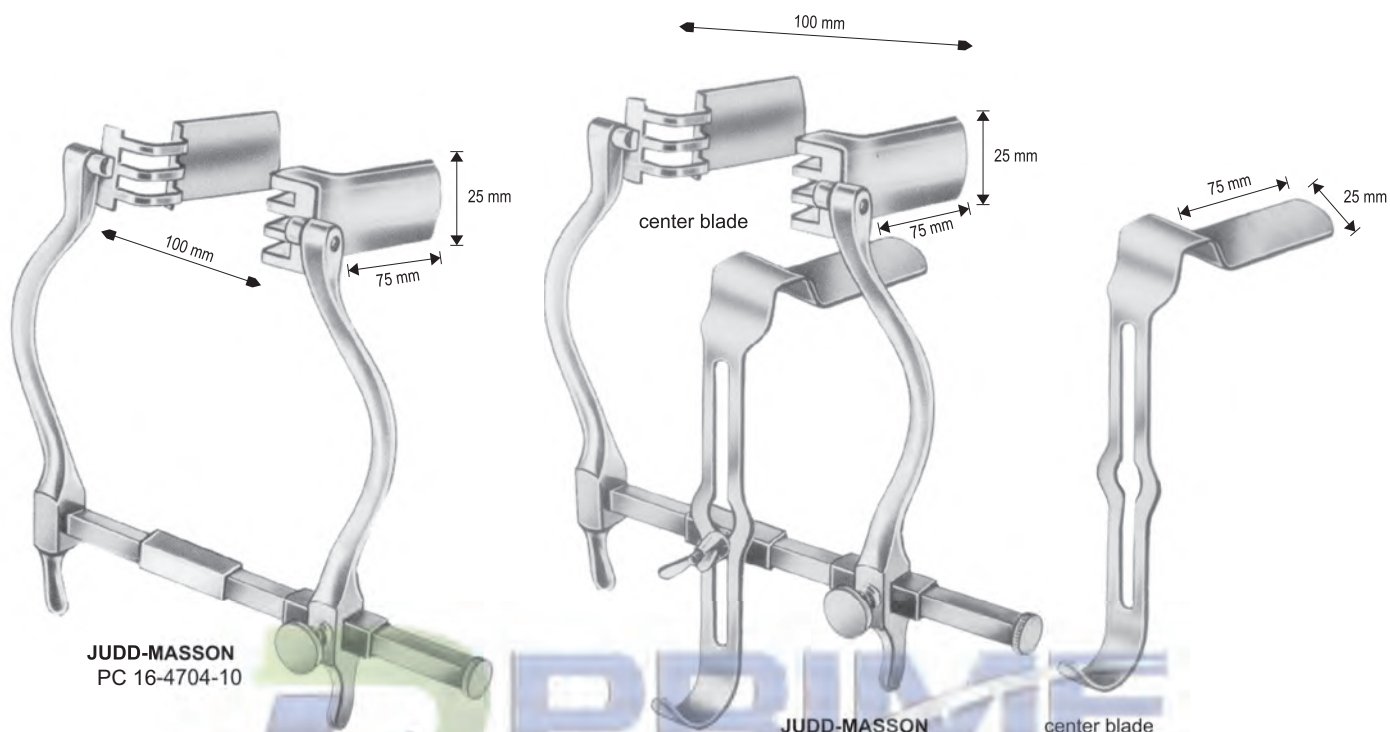

**JUDD-MASSON**  
PC 16-4704-10

**JUDD-MASSON**  
PC 16-4705-75

center blade



**O'SULLIVAN-O'CONNOR**  
PC 16-4706-00

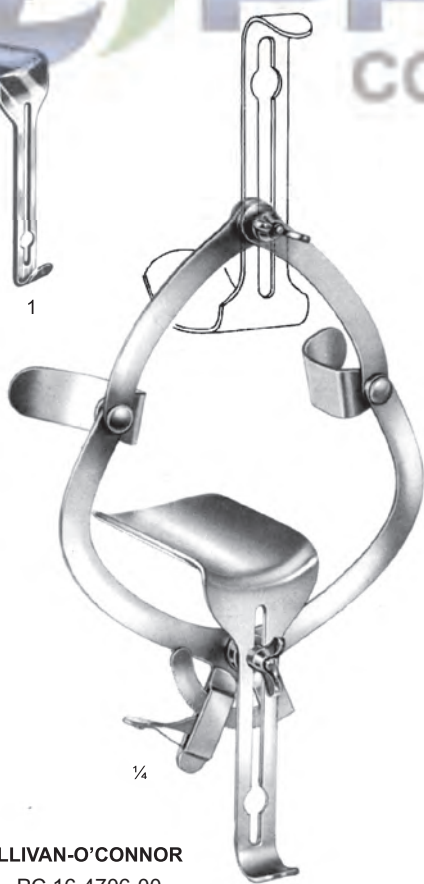

¼



blade only

**DOYEN**  
PC 16-4707-55 55 x 95 mm  
PC 16-4708-55 55 x 105 mm  
PC 16-4709-55 55 x 115 mm  
PC 16-4710-55 55 x 125 mm

Measurements of retractors: Depth x Width

Abdominal Retractors ●— EN  
 Bauchdeckenhalter ●— DE  
 Separadores abdominales ●— ES

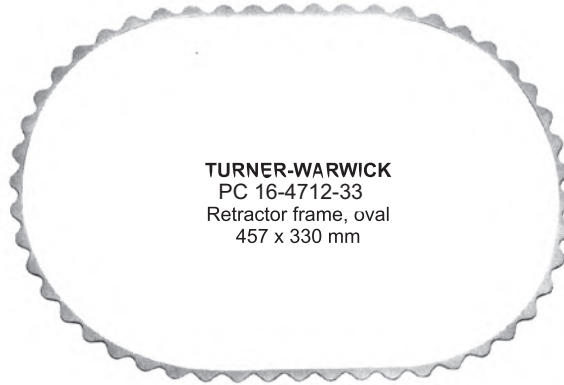
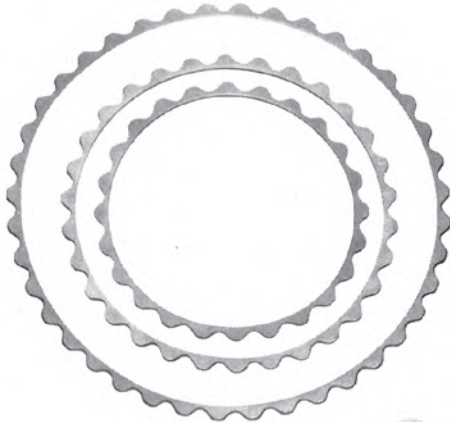

**TURNER-WARWICK**  
 PC 16-4712-33  
 Retractor frame, oval  
 457 x 330 mm

**TURNER-WARWICK**  
 Retractor frame, round  
 PC 16-4711-18Ø 18 cm/7 1/8"  
 PC 16-4711-23Ø 23cm/9"  
 PC 16-4711-30Ø 30.5cm/12"



**TURNER-WARWICK**  
 PC 16-4713-33  
 Abdominal retractor, complete  
 consisting of  
 1 frame PC 16-4714-33  
 2 retractor blades of eac PC 16-4715-33  
 2 abdominal retractor of each PC 16-4716-33  
 2 abdominal retractor of each PC 16-4717-33  
 2 retractor blade single hooks PC 16-4718-33



PC 16-4719-19  
 malleable  
 76 x 19 mm

PC 16-4720-38  
 malleable  
 102 x 38 mm

PC 16-4721-57  
 malleable  
 89 x 57 mm

PC 16-4722-57  
 malleable  
 114 x 57 mm

PC 16-4723-38  
 51 x 38 mm

PC 16-4724-60  
 76 x 60 mm

PC 16-4725-60  
 89 x 60 mm

PC 16-4726-60  
 114 x 60 mm

PC 16-4727-60  
 13 mm tief  
 13 mm deep



- EN —● Abdominal Retractors
- DE —● Bauchdeckenhalter
- ES —● Separadores abdominales

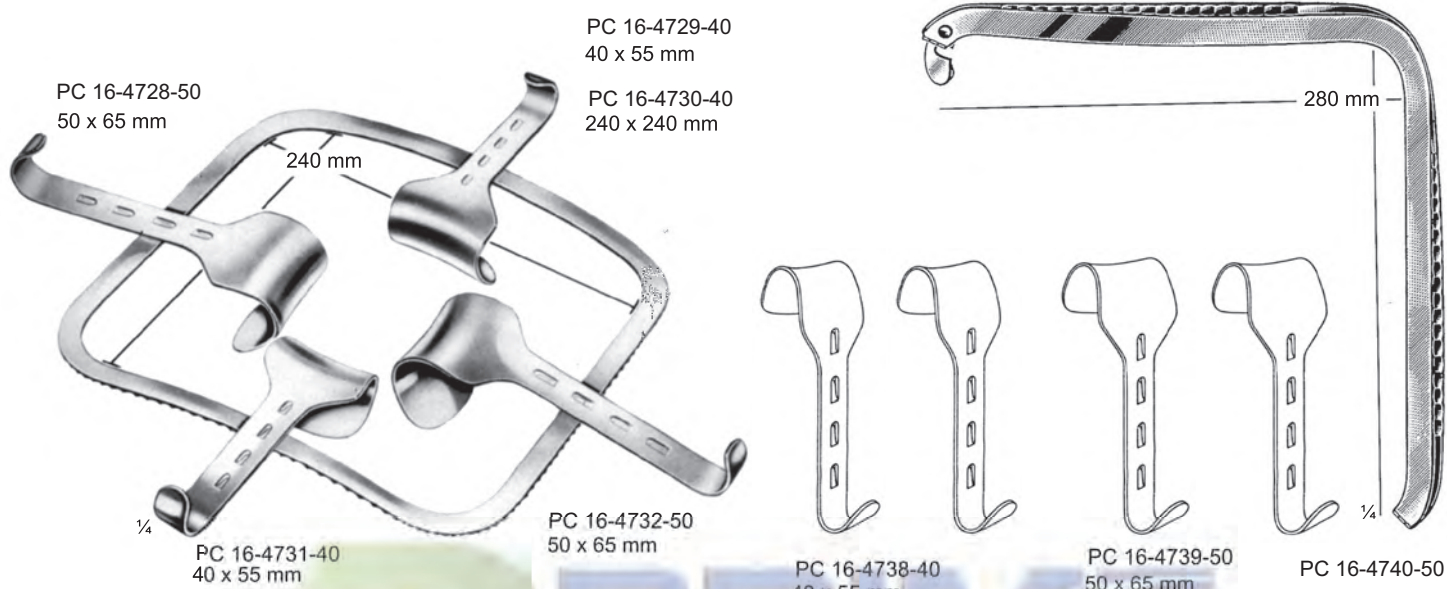

**KIRSCHNER**  
PC 16-4733-00

- PC 16-4734-00 - Kirschner, Abdominal Retractor - complete, consisting of:
- PC 16-4735-00 - 2 Hook-on retractors, 40 x 55 mm
- PC 16-4736-00 - 2 ditto, 50 x 65 mm
- PC 16-44737-00 - Frame only, rigid, 240 x 240 mm

**KIRSCHNER**  
PC 16-4741-00

- PC 16-4742-00- Kirschner, Abdominal Retractor, folding, - large size, complete, consisting of:
- PC 16-4743-00- 1 Frame folding type, large size - 280 x 280 mm
- PC 16-4744-00- 2 Hook-on retractors, 40 x 55 mm
- PC 16-4745-00- 2 ditto, 50 x 65 mm
- PC 16-4746-00- Frame only, folding type 280 x 280 mm

Hook-on Retractors for Kirschner and Franz Frames

for corpulent patients

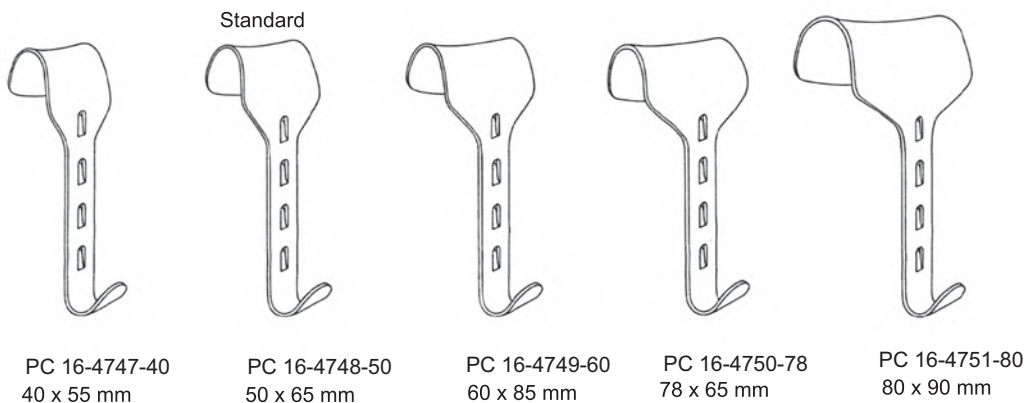

Measurements of retractors: Depth x Width



Abdominal Retractors ●— EN  
 Bauchdeckenhalter ●— DE  
 Separadores abdominales ●— ES

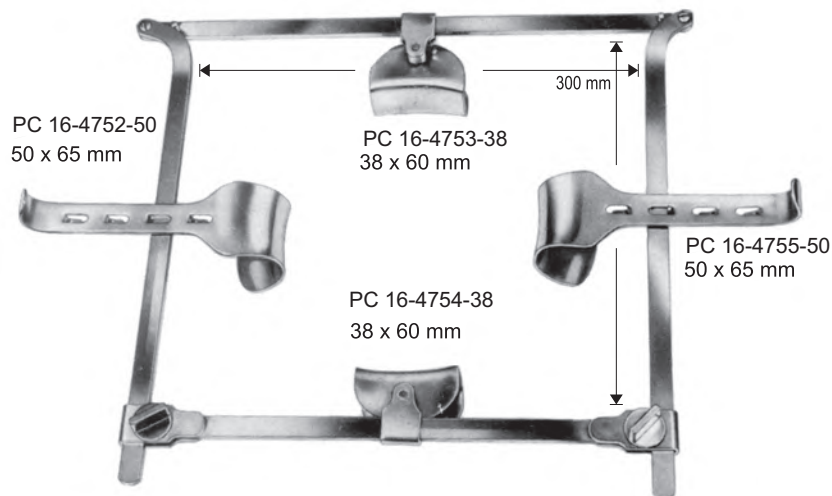

**FRANZ (Complete)**

PC 16-4756-38 with 4 blades  
 PC 16-4757-38 with 8 blades

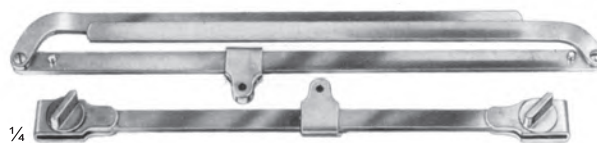

**Folding frame**

PC 16-4759-45  
 45 x 80 mm



PC 16-4763-50 - Franz, Abdominal Retractor, folding, - complete, consisting of:  
 PC 16-4764-50 - 2 Hook-on retractors, 50 x 65 mm  
 PC 16-4765-50 - 2 exchangeable blades 38 x 60 mm  
 PC 16-4766-50 - Frame, folding, only, 300 x 300 mm

PC 16-4767-30 - Franz, Abdominal Retractor, folding, - complete, consisting of:  
 PC 16-4768-30 - 1 Frame folding, 300 x 300 mm  
 PC 16-4769-30 - 2 Hook-on retractors, 50 x 65 mm  
 PC 16-4770-30 - 2 ditto, 60 x 85 mm  
 PC 16-4771-30 - 2 exchangeable blades 38 x 60 mm  
 PC 16-4772-30 - 2 ditto, 45 x 80 mm

**Intestinal and bladder**

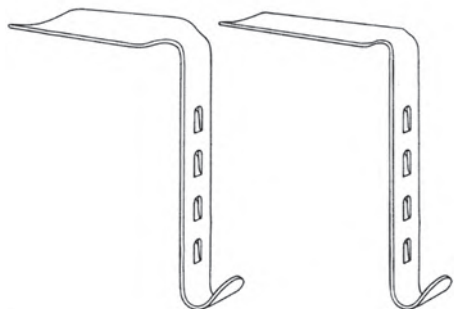

PC 16-4773-98  
 98 x 50 mm

PC 16-4774-35  
 105 x 35 mm



PC 16-4775-38  
 38 x 60 mm



PC 16-4776-45  
 45 x 80 mm

- EN —● Abdominal Retractors
- DE —● Bauchdeckenhalter
- ES —● Separadores abdominales

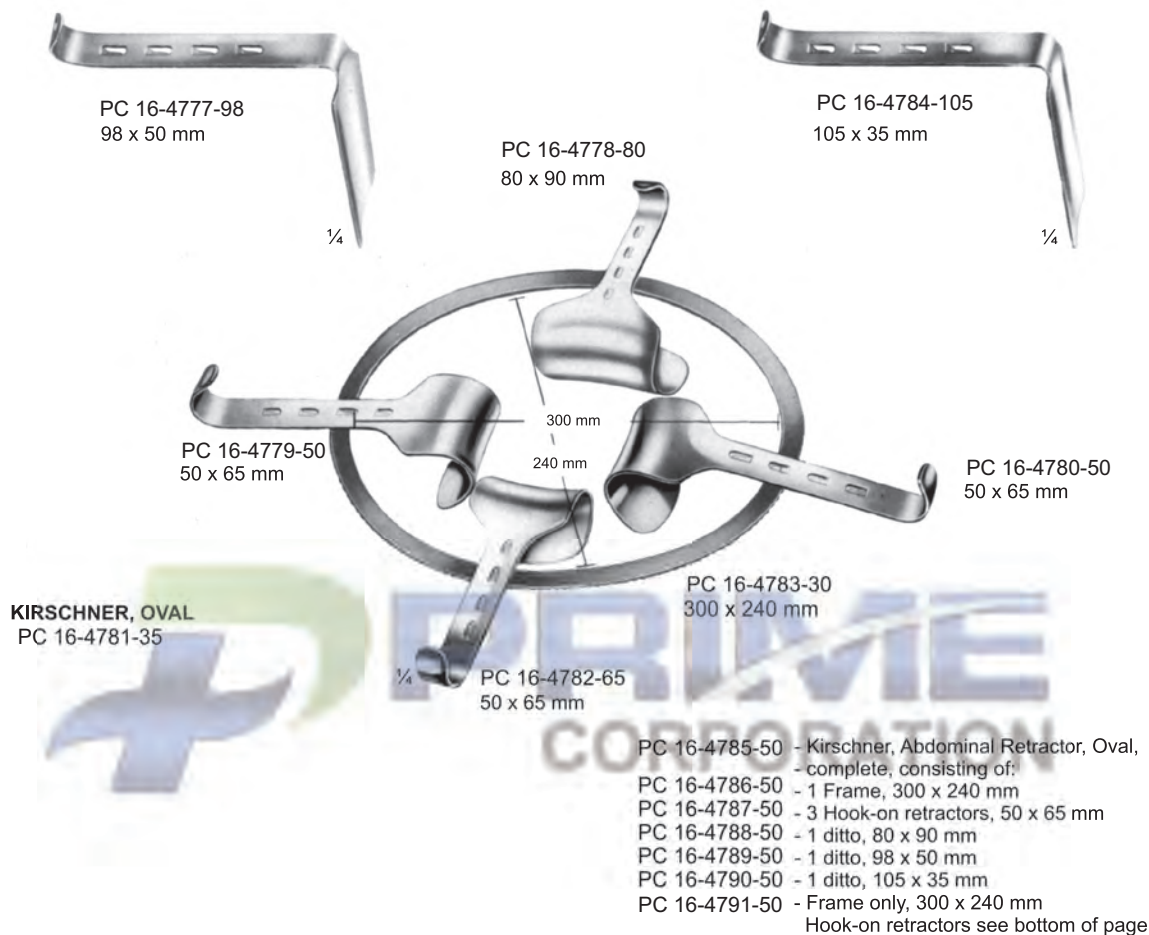

Hook-on Retractors for Kirschner and Franz Frames

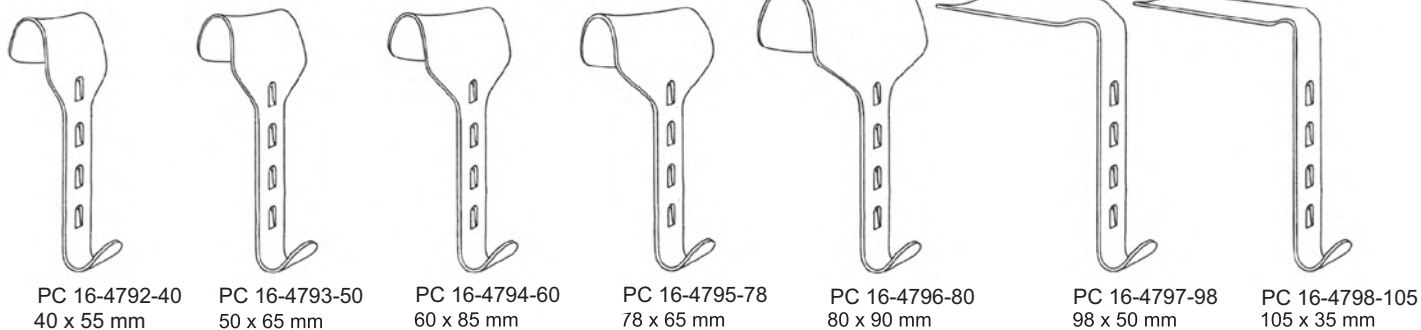

Measurements of retractors: Depth x Width

- Abdominal Retractors ● EN
- Bauchdeckenhalter ● DE
- Separadores abdominales ● ES

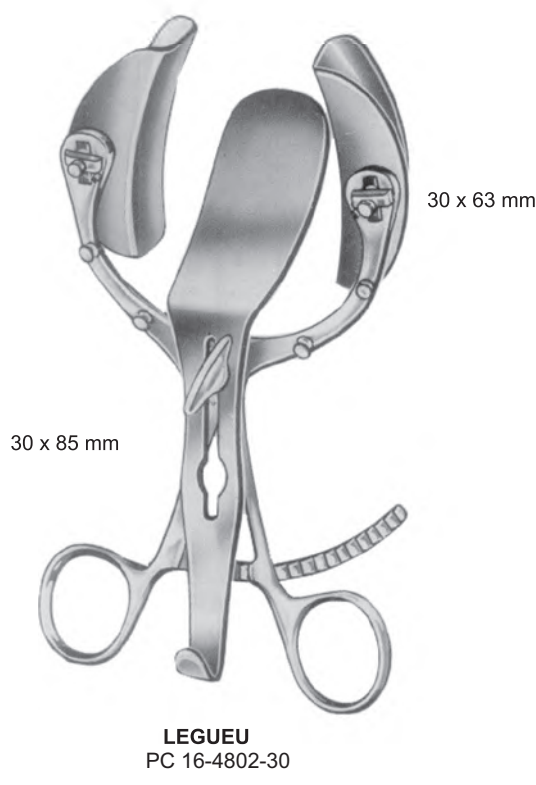
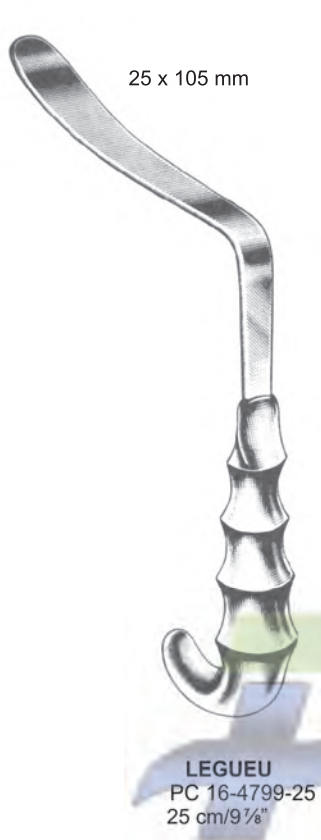

- EN —● Abdominal Retractors
- DE —● Bauchdeckenhalter
- ES —● Separadores abdominales

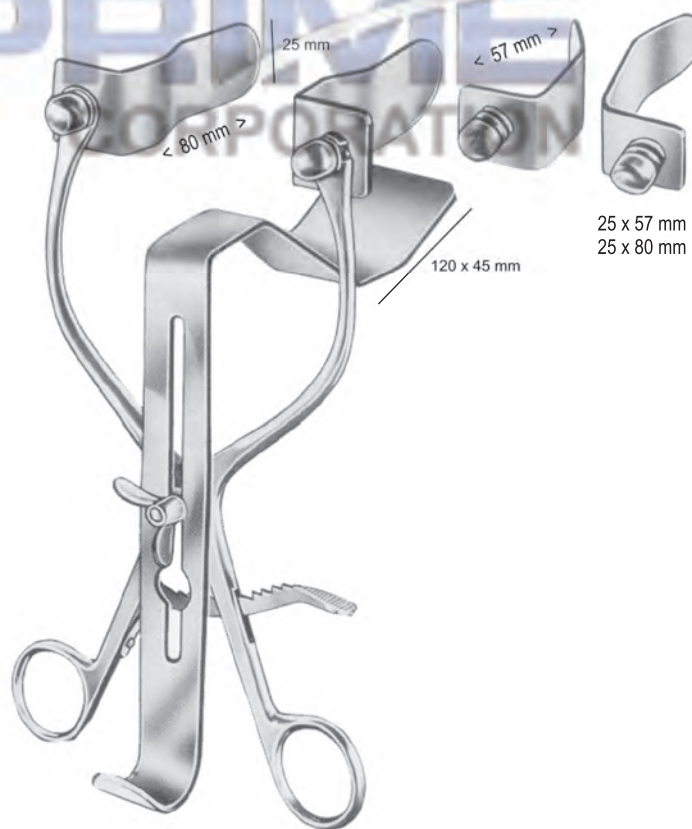

**MILLIN**  
PC 16-4804-25

Measurements of retractors: Depth x Width



**EN** Neurosurgery

**DE** Neurochirurgie

**ES** Neuro Cirugía

Page 373 to 387

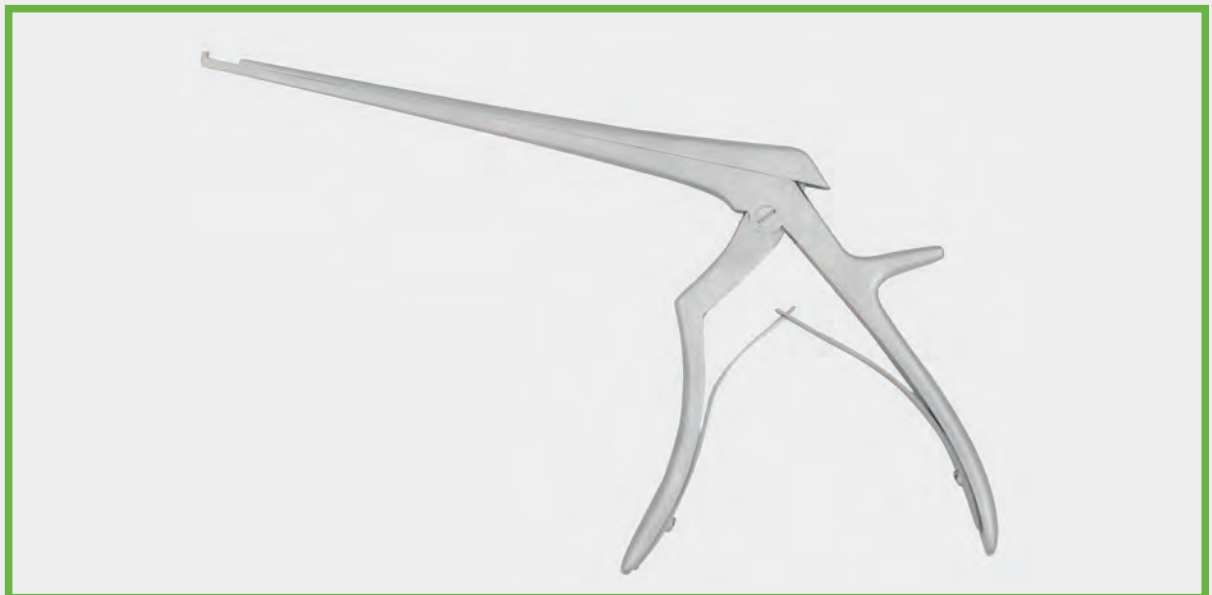

- EN —● Dura Hooks, Nerve Hooks, Dura Dissectors
- DE —● Durahaken, Nervhaken, Dura-Dissektoren
- ES —● Ganchos para dura-madre, Ganchos para nervios, Disecadores de dura-madre



**FRAZIER**  
PC 18-5301-15  
15 cm/5 3/8"



**HOEN**  
PC 18-5302-15  
15 cm/5 3/8"



**HOEN**  
PC 18-5303-15  
15 cm/5 3/8"



**SACHS**  
PC 18-5304-21  
21 cm/8 1/4"



**MILLIGAN**  
PC 18-5305-21  
21 cm/8 1/4"



**SACHS**  
PC 18-5306-21  
21 cm/8 1/4"



PC 18-5307-22  
22 cm/8 3/4"

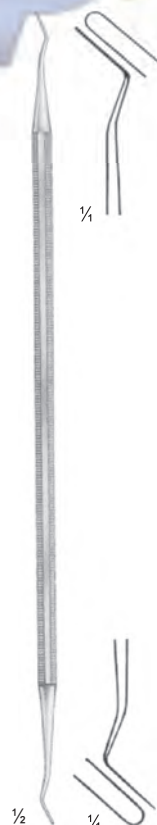

**WOODSON**  
PC 18-5308-25  
25 cm/9 1/8"



**DAVIS**  
PC 18-5309-24  
24.5 cm/9 5/8"



PC 18-5310-21  
21 cm/8 1/4"



**FAGER**  
PC 18-5311-20  
20 cm/7 1/8"



**FAGER**  
PC 18-5312-20  
20 cm/7 1/8"

Nerve Root Retractors, Dura Dissectors ● EN

Nervwurzelhaken, Dura-Dissektoren ● DE

Separadues para la raiz de nervio, Disecadores de dura-madre ● ES

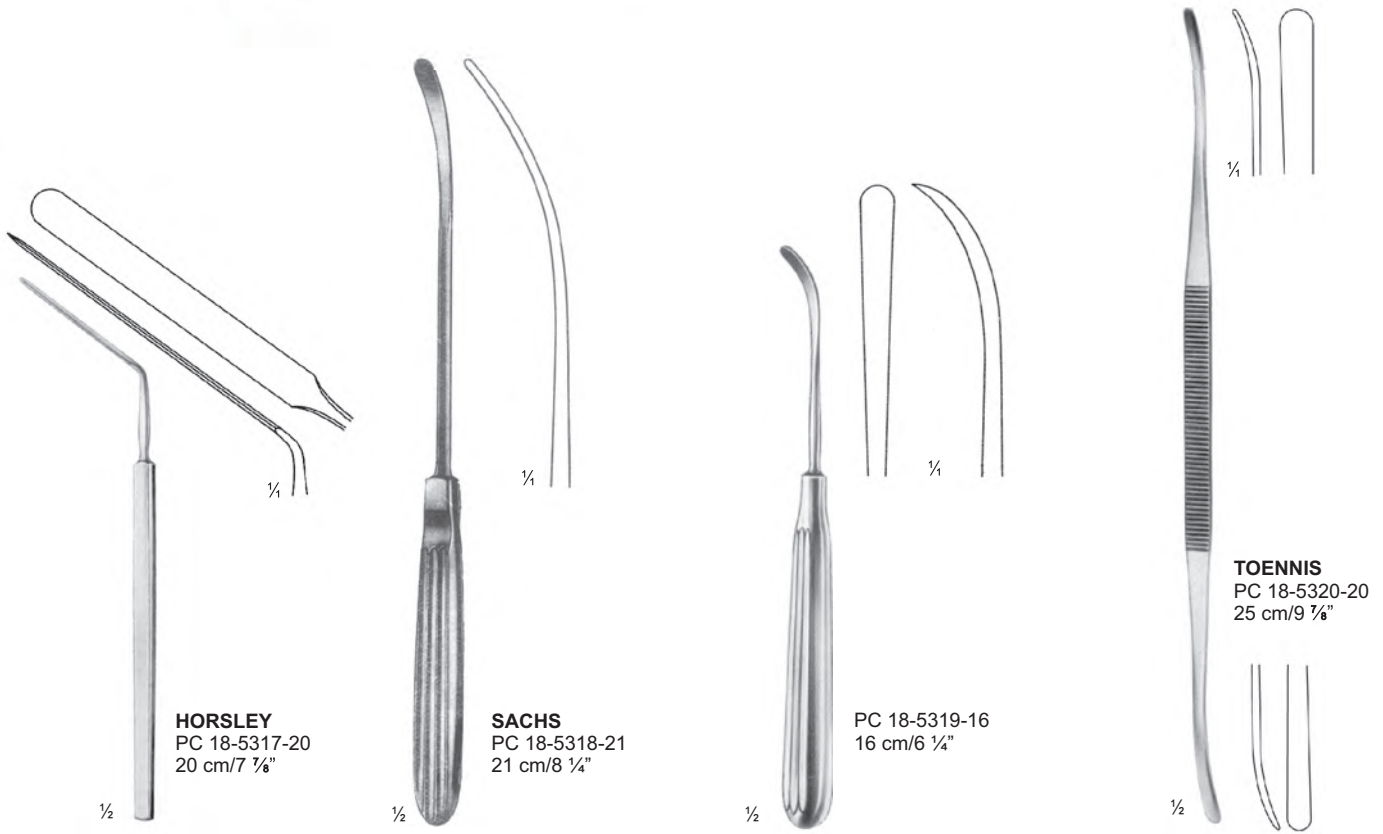
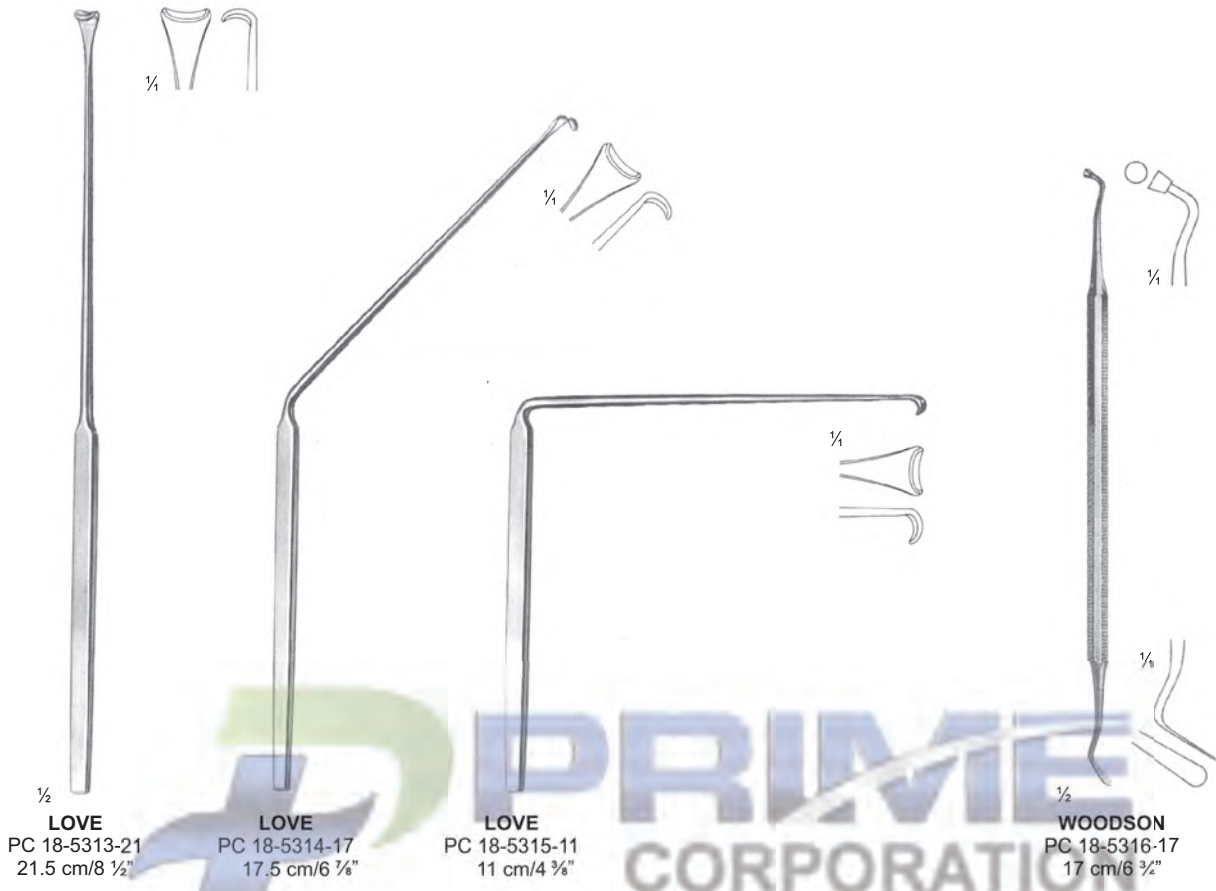

- EN —●— Cranial Opening, Clip Applying Forceps
- DE —●— Schädelzangen, Clips und Anlegezangen
- ES —●— Pinzas sacabocados craneales, Grapas y pinzas aplicadoras

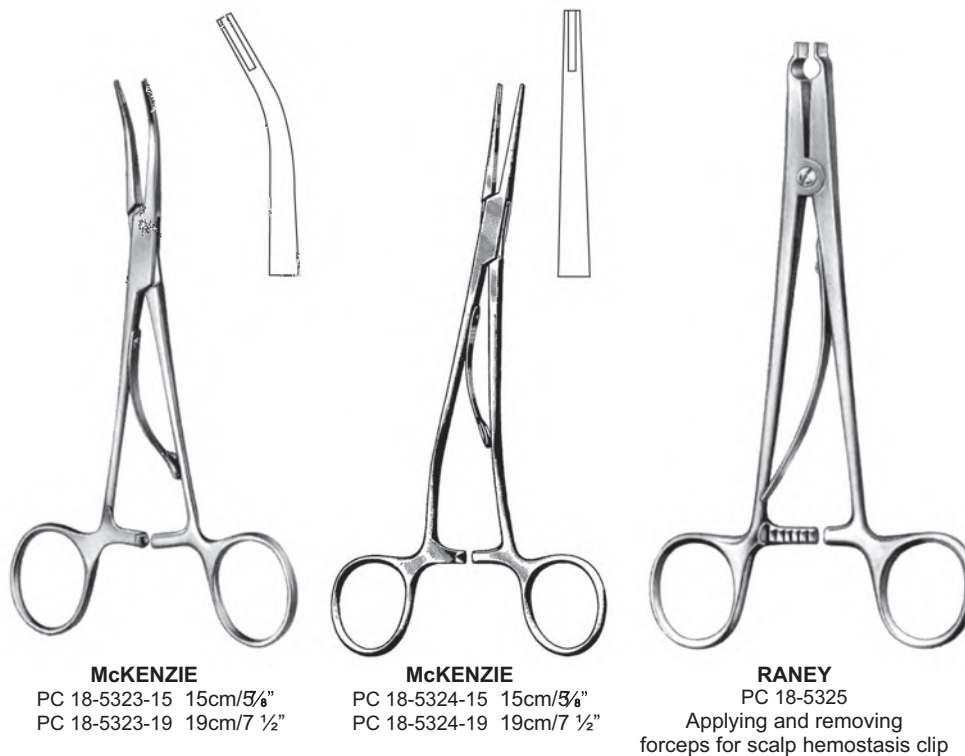
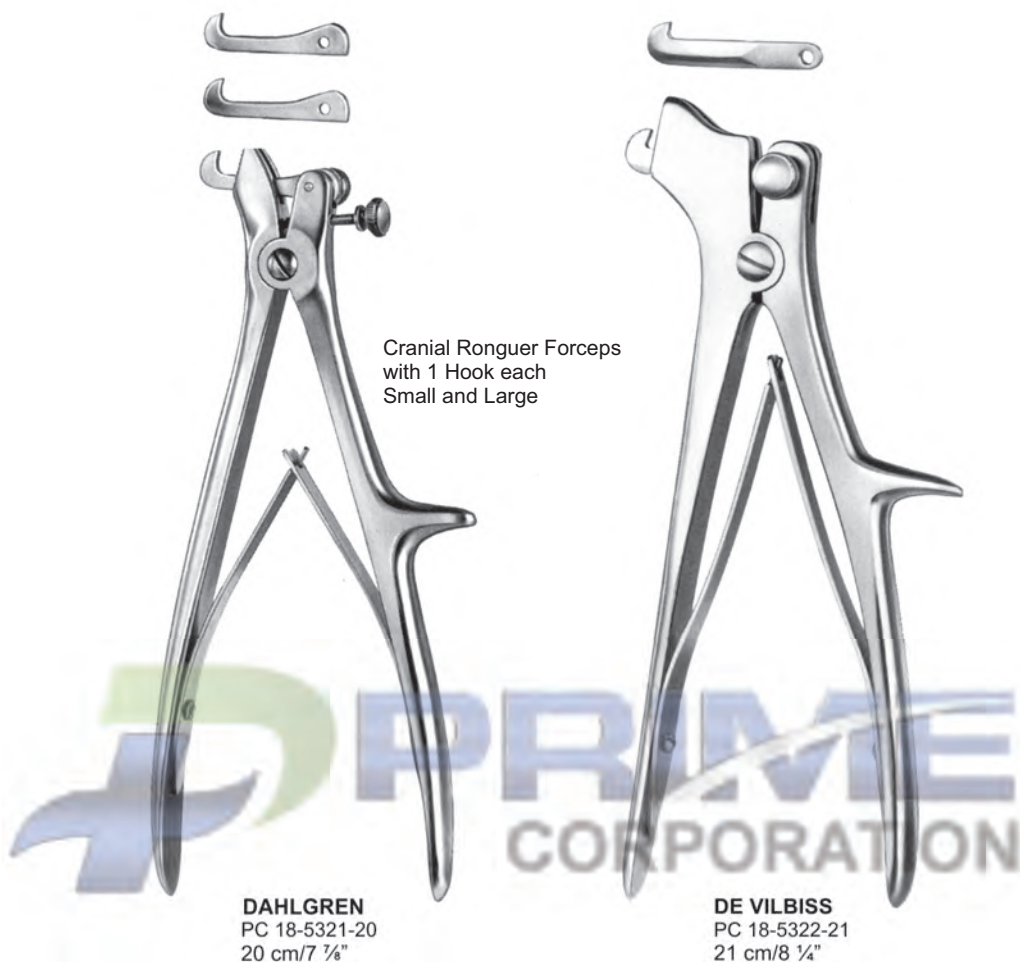



Wire Saws ●— EN  
 Drahtsägen ●— DE  
 Sierras de hilo ●— ES



PC 18-5326-30 30cm  
 PC 18-5326-40 40cm  
 PC 18-5326-50 50cm  
 PC 18-5326-60 60cm  
 PC 18-5326-70 70cm

**GIGLI-WIRE SAW**  
 2 wires twisted

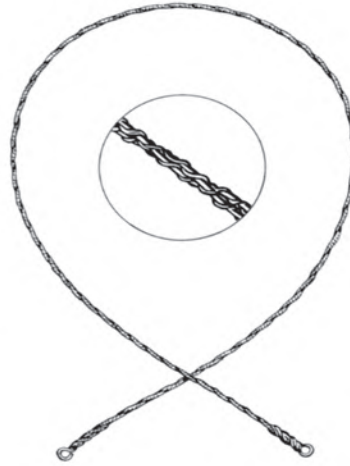

PC 18-5327-30 30cm  
 PC 18-5327-40 40cm  
 PC 18-5327-50 50cm

**GIGLI-WIRE SAW**  
 6 wires twisted



**GIGLI**  
 PC 18-5328-07  
 7 cm/2 3/4"  
 Hook handle  
 for wire saw



**De MARTEL**  
 PC 18-5329-33  
 33 cm/13"  
 Conductor for  
 wire saws

- EN —● Brain Spatulas, Nerve Root Retractors
- DE —● Himspatel, Nervwurzelhaken
- ES —● Espatulas cerebrales, Separadues para la raiz de nervio



**CUSHING**  
 PC 18-5330-17 17cm/6 3/4"  
 PC 18-5330-20 20cm/7 7/8"  
 PC 18-5330-28 28cm/11"



**OLIVECRONA**  
 18 cm/7 1/8"  
 width of spatulas

Concave	upper end
PC 18-5331-18	7 + 9 mm
PC 18-5332-18	11 + 13 mm
PC 18-5333-18	15 + 18 mm
PC 18-5334-18	18 + 22 mm



Convex  
 PC 18-5335-18  
 PC 18-5336-18  
 PC 18-5337-18  
 PC 18-5338-18



**SCOVILLE**  
 PC 18-5339-23  
 23 cm/9"



**HOLSHER**  
 PC 18-5340-24  
 24 cm/9 1/2"

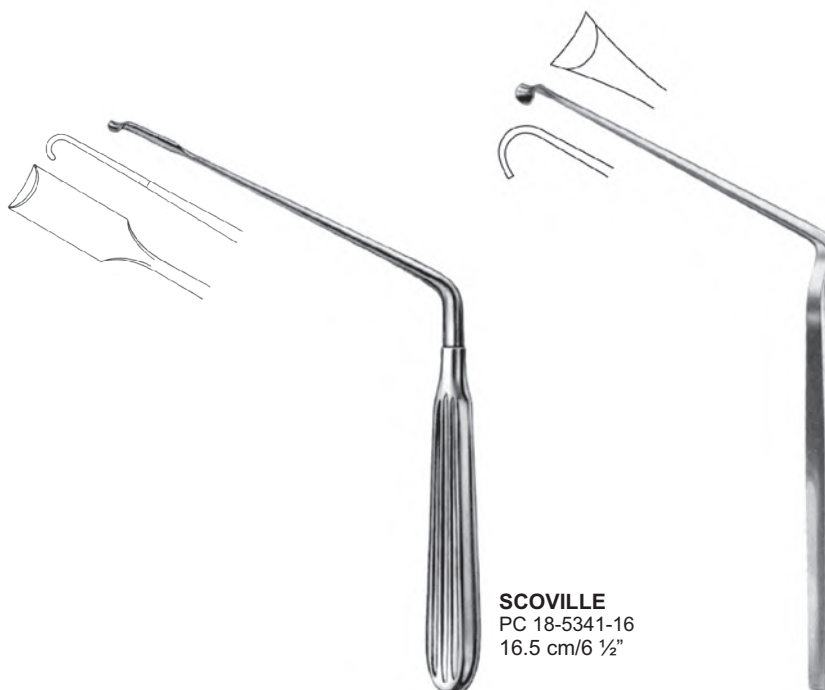

**SCOVILLE**  
 PC 18-5341-16  
 16.5 cm/6 1/2"

PC 18-5342-21  
 21 cm/8 1/4"

Nerve Hooks ●— EN  
 Nervhaken ●— DE  
 Ganchos para nervios ●— ES

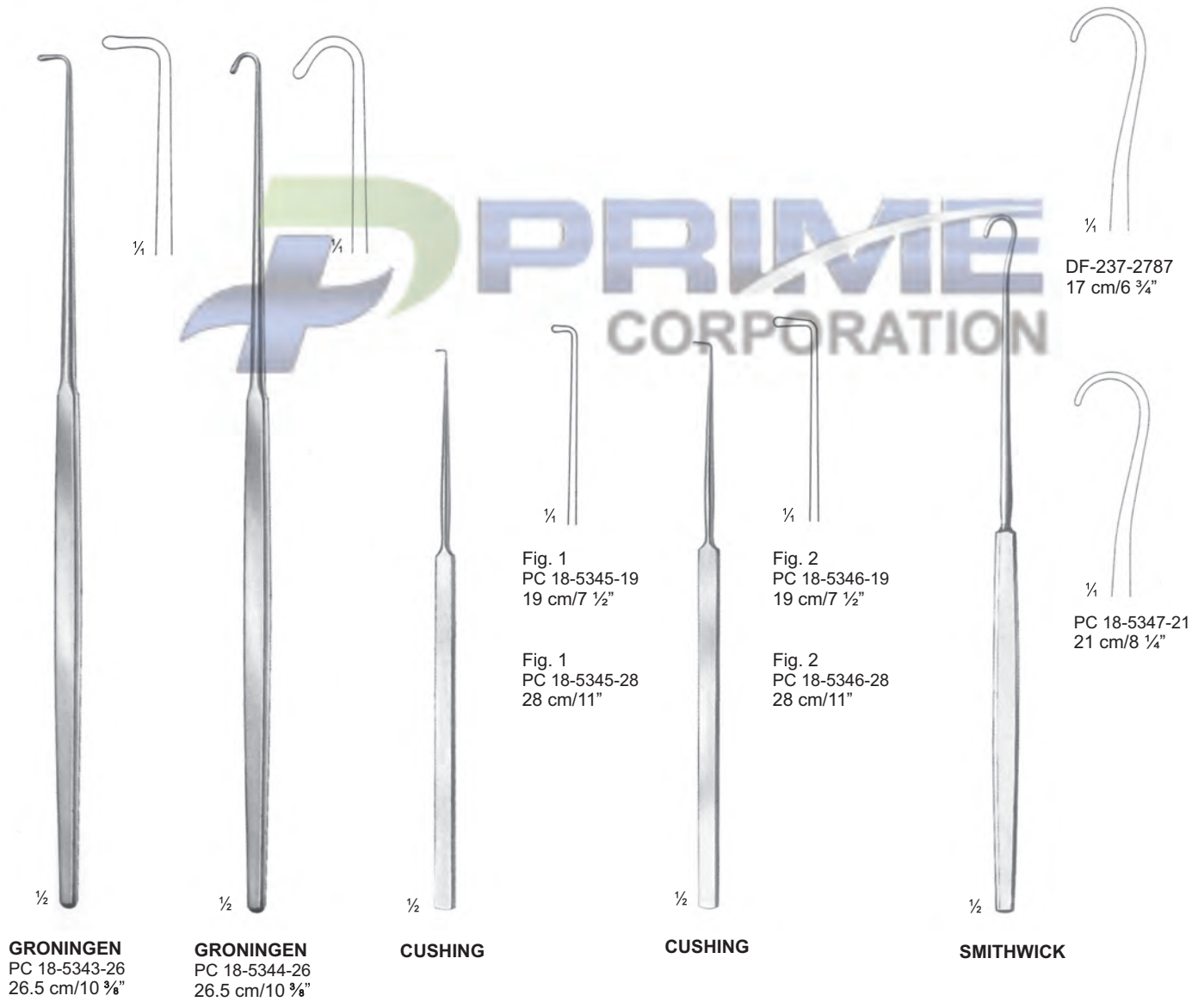

- EN —● Dura Hooks
- DE —● Durahaken
- ES —● Gánchos para duramadre

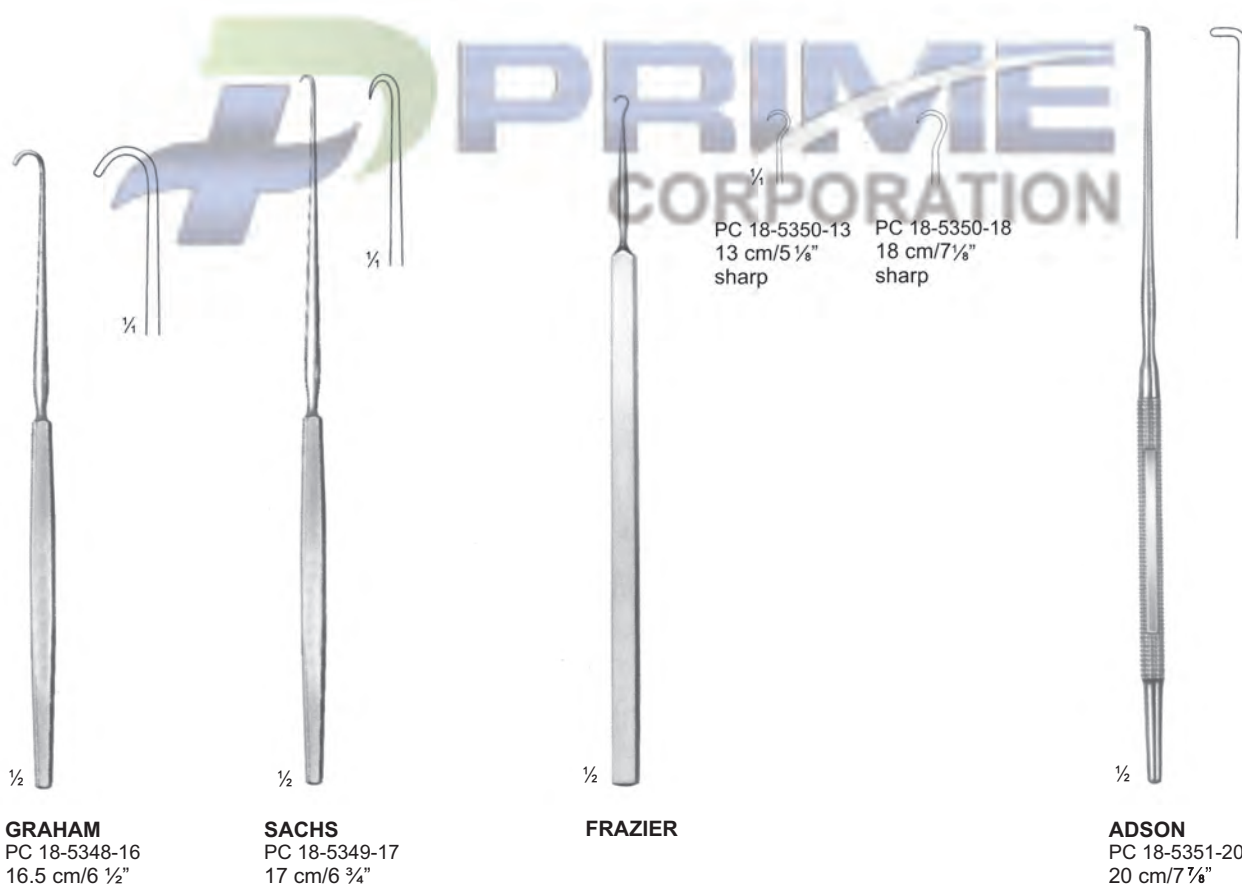



- Nerve and Vessel Hooklets ●— EN
- Nerv- und Gefäßhäkchen ●— DE
- Ganchitos para nervios y vasos ●— ES

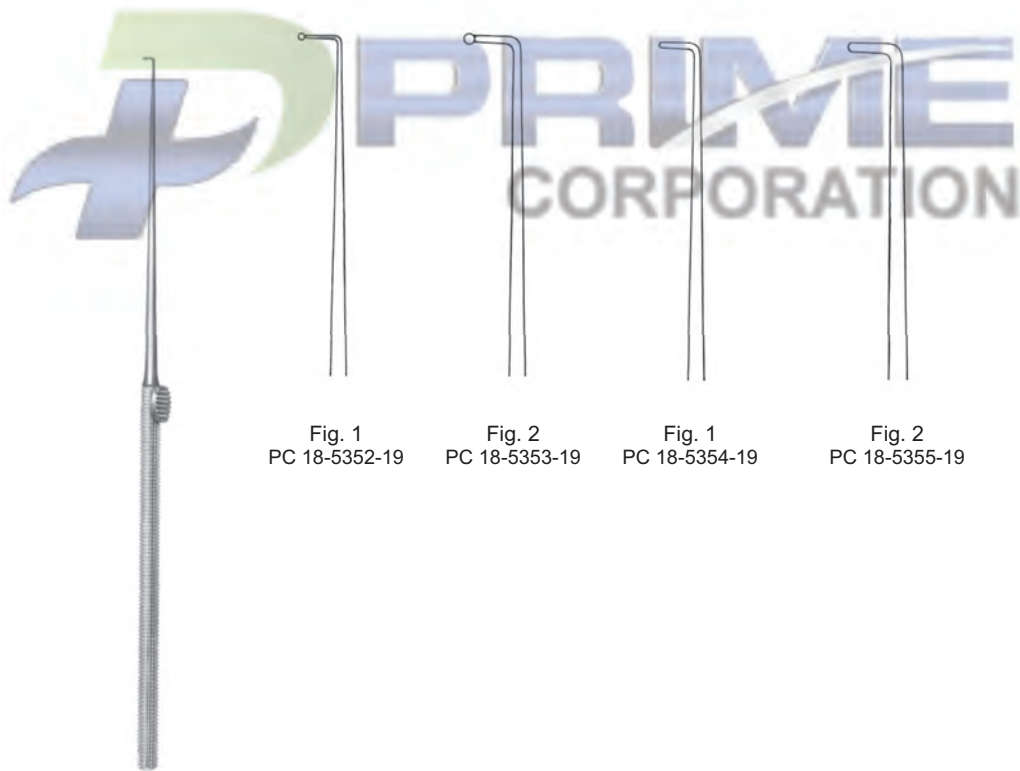

**KRAYENBÜHL**  
19 cm/7 ½"

- EN —● Lamina Spreaders
- DE —● Wirbelkörperspeizer
- ES —● Separadores para cuerpos vertebrales

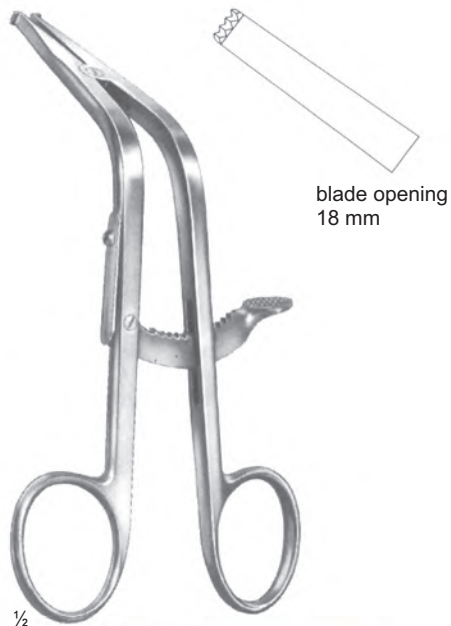

**CLOWARD**  
PC 18-5356-16  
16 cm/6 1/4"

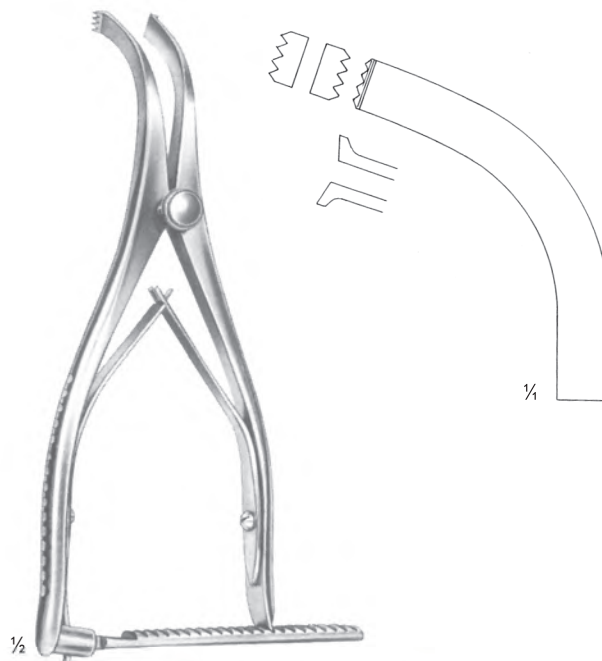

**INGE**  
PC 18-5357-16  
16.5 cm/6 1/2"  
Blade opening 35 mm



**INGE**  
PC 18-5358-25  
25.5 cm/10"  
Blade opening 70 mm

Laminectomy Punches ● EN  
 Laminektomiestanzen ● DE  
 Pinzas cortantes para laminectomía ● ES

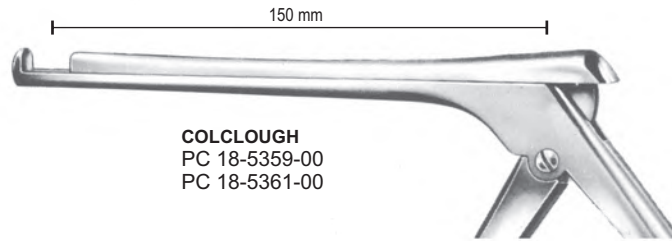

**COLCLOUGH**  
 PC 18-5359-00  
 PC 18-5361-00

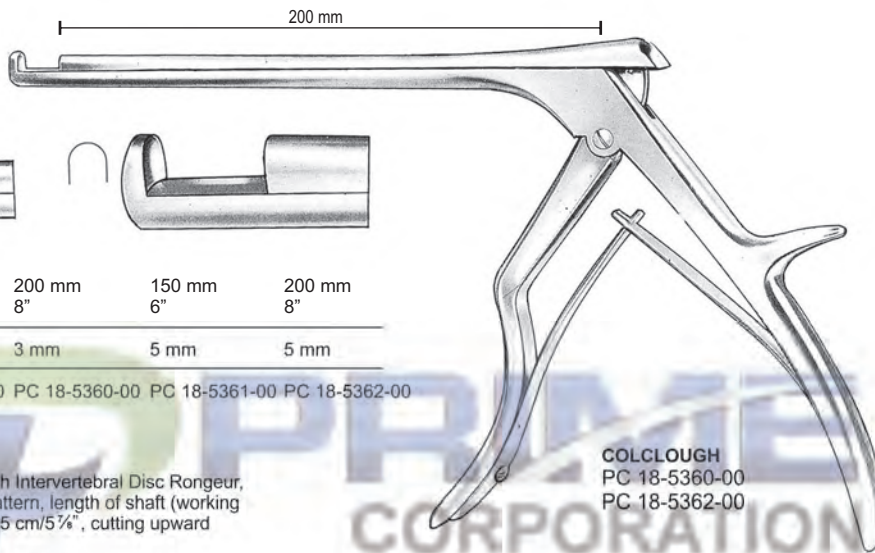

**COLCLOUGH**  
 PC 18-5360-00  
 PC 18-5362-00

Length of shaft	150 mm 6"	200 mm 8"	150 mm 6"	200 mm 8"
Width of bite	3 mm	3 mm	5 mm	5 mm
Cat. Ref.	PC 18-5359-00	PC 18-5360-00	PC 18-5361-00	PC 18-5362-00

PC 18-5359-00 - PC 18-5361-00 Colclough Intervertebral Disc Rongeur, heavy pattern, length of shaft (working length) 15 cm/5 7/8", cutting upward desired.

PC 18-5360-00 - PC 18-5362-00 ditto, length of shaft (working length) 20 cm/7 7/8"

PC 18-5362-00 - PC 18-5363-00 ditto, length of shaft (working length) 15 cm/5 7/8", cutting downward

PC 18-5362-00 - PC 18-5362-00 ditto, length of shaft (working length) 20 cm/7 7/8"

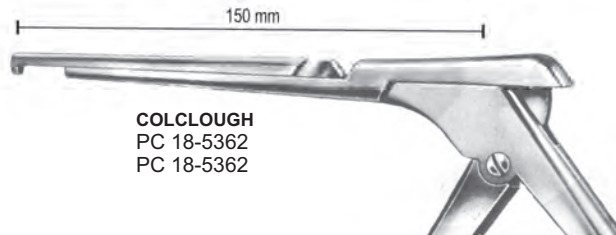

**COLCLOUGH**  
 PC 18-5362  
 PC 18-5362

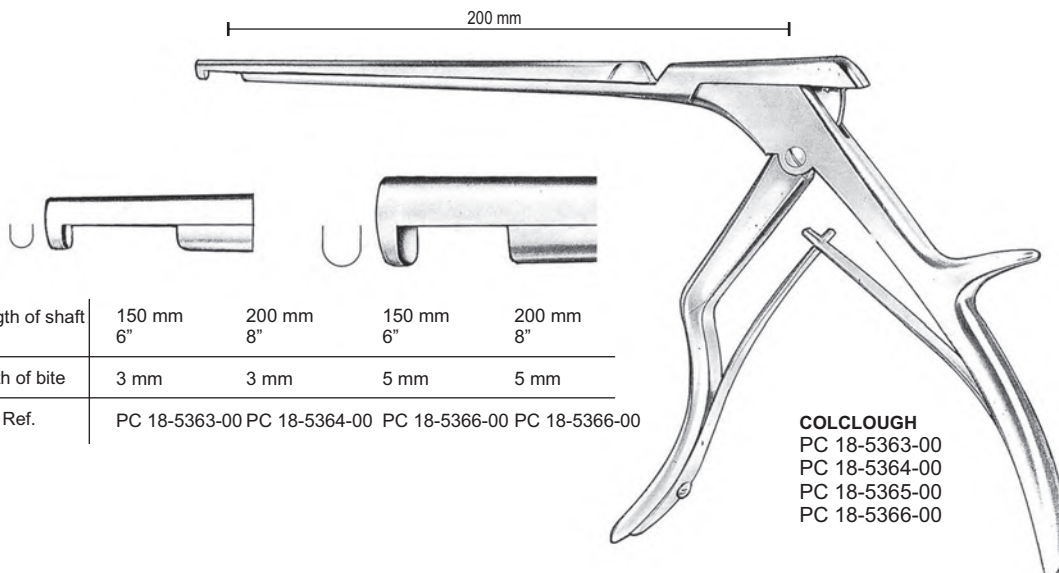

Length of shaft	150 mm 6"	200 mm 8"	150 mm 6"	200 mm 8"
Width of bite	3 mm	3 mm	5 mm	5 mm
Cat. Ref.	PC 18-5363-00	PC 18-5364-00	PC 18-5365-00	PC 18-5366-00

**COLCLOUGH**  
 PC 18-5363-00  
 PC 18-5364-00  
 PC 18-5365-00  
 PC 18-5366-00

- EN —● Lamina Spreaders
- DE —● Wirbelkörperspeizer
- ES —● Separadores para cuerpos vertebrales

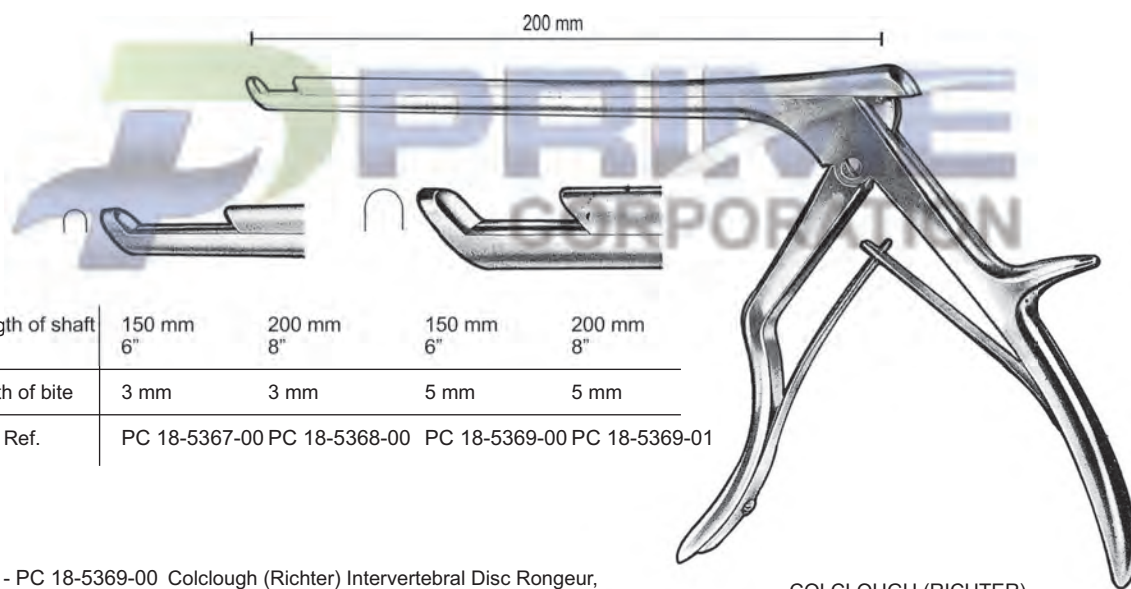
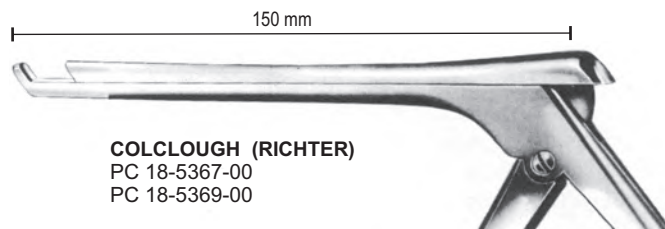

PC 18-5367-00 - PC 18-5369-00 Colclough (Richter) Intervertebral Disc Rongeur, heavy pattern, length of shaft (working length) 15 cm/6", cutting 40° forward

**COLCLOUGH (RICHTER)**  
PC 18-5368-00  
PC 18-5369-01

PC 18-5368-00 - PC 18-5369-01 ditto, length of shaft (working length) 20 cm/7 7/8"



Laminectomy Punches ●— EN  
 Laminektomiestanzen ●— DE  
 Pinzas cortantes para laminectomía ●— ES

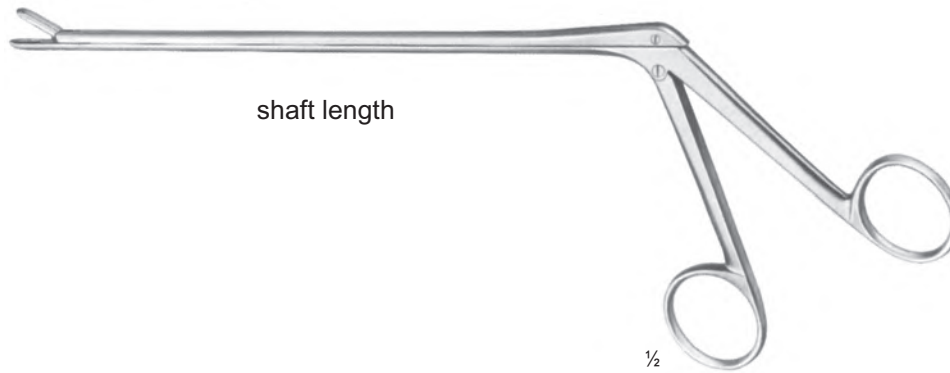

<p><b>CUSHING</b> straight</p> <p>PC 18-5370-12 120 mm              PC 18-5370-15 150 mm              PC 18-5370-18 180 mm</p>	<p><b>CUSHING</b> upwards</p> <p>PC 18-5371-12 120 mm              PC 18-5371-15 150 mm              PC 18-5371-18 180 mm</p>	<p><b>CUSHING</b> downwards</p> <p>PC 18-5372-12 120 mm              PC 18-5372-15 150 mm              PC 18-5372-18 180 mm</p>
--	---	---

<p><b>LOVE-GRUENWALD</b> straight</p> <p>PC 18-5373-12 120 mm              PC 18-5373-15 150 mm              PC 18-5373-18 180 mm</p>	<p><b>LOVE-GRUENWALD</b> upwards</p> <p>PC 18-5374-12 120 mm              PC 18-5374-15 150 mm              PC 18-5374-18 180 mm</p>	<p><b>LOVE-GRUENWALD</b> downwards</p> <p>PC 18-5375-12 120 mm              PC 18-5375-15 150 mm              PC 18-5375-18 180 mm</p>
---	--	--

<p><b>SPURLING</b> straight</p> <p>PC 18-5376-12 120 mm              PC 18-5376-15 150 mm              PC 18-5376-18 180 mm</p>	<p><b>SPURLING</b> upwards</p> <p>PC 18-5377-12 120 mm              PC 18-5377-15 150 mm              PC 18-5377-18 180 mm</p>	<p><b>SPURLING</b> downwards</p> <p>PC 18-5378-12 120 mm              PC 18-5378-15 150 mm              PC 18-5378-18 180 mm</p>
---	--	--

EN —● Laminectomy Punches  
 DE —● Laminektomiestanzen  
 ES —● Pinzas cortantes para laminectomía

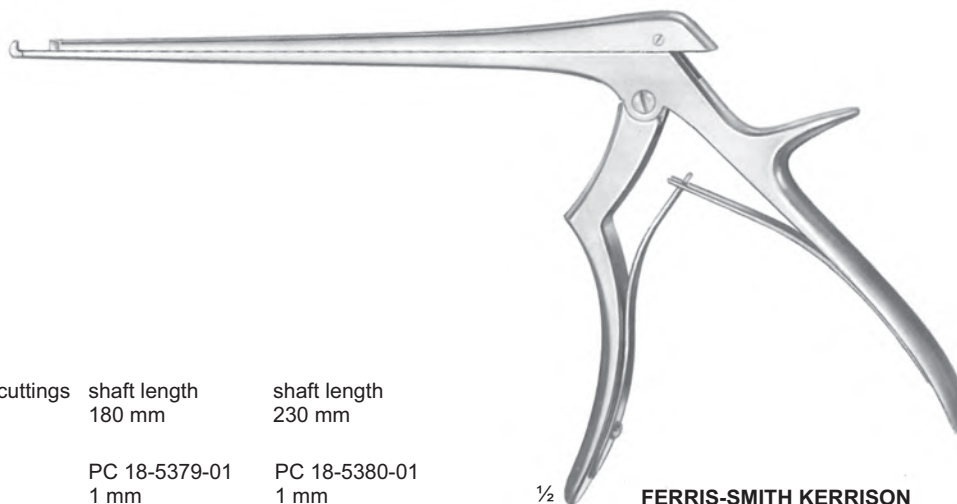

upwards cuttings	shaft length 180 mm	shaft length 230 mm	
	PC 18-5379-01 1 mm	PC 18-5380-01 1 mm	
	PC 18-5379-02 2 mm	PC 18-5380-02 2 mm	
	PC 18-5379-03 3 mm	PC 18-5380-03 3 mm	
	PC 18-5379-04 4 mm	PC 18-5380-04 4 mm	
	PC 18-5379-05 5 mm	PC 18-5380-05 5 mm	
	PC 18-5379-06 6 mm	PC 18-5380-06 6 mm	
			downwards cuttings
			shaft length 180 mm
			PC 18-5383-03 3 mm

downwards cuttings	shaft length 180 mm	shaft length 230 mm	upwards cuttings	shaft length 180 mm	shaft length 230 mm
	PC 18-5381-01 1 mm	PC 18-5382-01 1 mm		PC 18-5384-01 1 mm	PC 18-5385-01 1 mm
	PC 18-5381-02 2 mm	PC 18-5382-02 2 mm		PC 18-5384-02 2 mm	PC 18-5385-02 2 mm
	PC 18-5383-03 3 mm	PC 18-5382-03 3 mm		PC 18-5384-03 3 mm	PC 18-5385-03 3 mm
	PC 18-5383-04 4 mm	PC 18-5382-04 4 mm		PC 18-5384-04 4 mm	PC 18-5385-04 4 mm
	PC 18-5383-05 5 mm	PC 18-5382-05 5 mm		PC 18-5384-05 5 mm	PC 18-5385-05 5 mm
	PC 18-5383-06 6 mm	PC 18-5382-06 6 mm		PC 18-5384-06 6 mm	PC 18-5385-06 6 mm

Laminectomy Punches ●— EN  
 Laminektomiestanzen ●— DE  
 Pinzas cortantes para laminectomía ●— ES



1/2

FERRIS-SMITH KERRISON



upwards cuttings	shaft length 180 mm	shaft length 230 mm	upwards cuttings	shaft length 180 mm	shaft length 230 mm
	PC 18-5386-1 1 mm	PC 18-5387-1 1 mm		PC 18-5388-1 1 mm	PC 18-5389-1 1 mm
	PC 18-5386-2 2 mm	PC 18-5387-2 2 mm		PC 18-5388-2 2 mm	PC 18-5389-2 2 mm
	PC 18-5386-3 3 mm	PC 18-5387-3 3 mm		PC 18-5388-3 3 mm	PC 18-5389-3 3 mm
	PC 18-5386-4 4 mm	PC 18-5387-4 4 mm		PC 18-5388-4 4 mm	PC 18-5389-4 4 mm
	PC 18-5386-5 5 mm	PC 18-5387-5 5 mm		PC 18-5388-5 5 mm	PC 18-5389-5 5 mm
	PC 18-5386-6 6 mm	PC 18-5387-6 6 mm		PC 18-5388-6 6 mm	PC 18-5389-6 6 mm

- EN —● Laminectomy Punches
- DE —● Laminektomiestanzen
- ES —● Pinzas cortantes para laminectomía



PC 18-5390-02  
Ø 2.2 mm



PC 18-5390-03  
Ø 3.5 mm

**YASARGIL**



PC 18-5391-09  
Ø 9.0 mm

**LANDOLT**  
Tumor grasping forceps, blunt

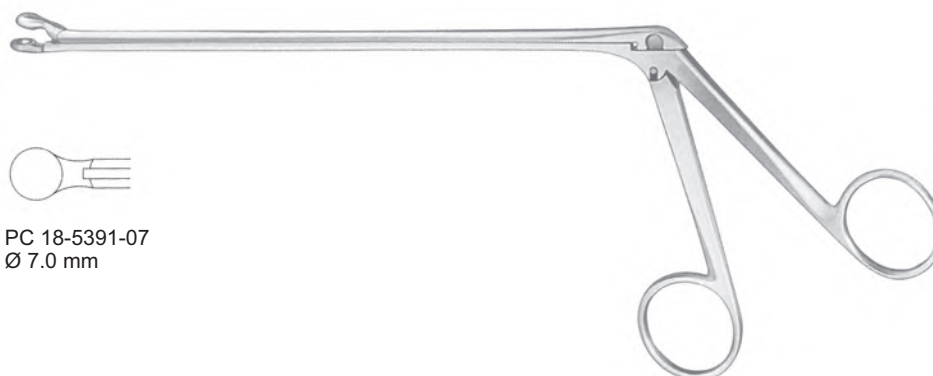

PC 18-5391-07  
Ø 7.0 mm

**OLDBERG**





- EN** Cardiovascular Surgery
- DE** Herz- und Gefäßchirurgie
- ES** Cirugía cardiovascular

Page 388 to 498

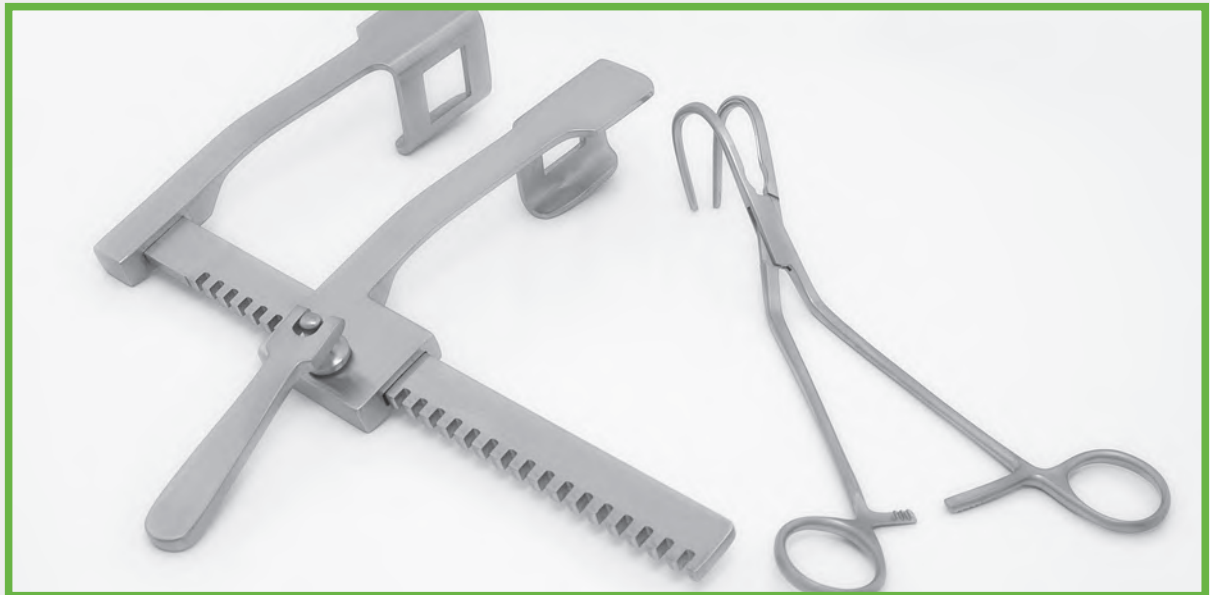

- EN —● Atrauma Tissue Forceps
- DE —● Atrauma Pinzetten
- ES —● Pinzas de disección Atrauma

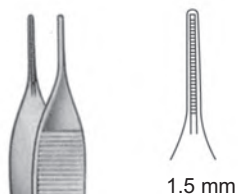

1.5 mm

PC 19-5501-12 12.5cm  
PC 19-5501-15 15cm

DEBAKEY-ADSON



DEBAKEY-GERALD

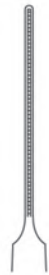

1.0 mm

PC 19-5502-15 15.0cm  
PC 19-5502-18 18.0cm

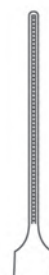

1.2 mm

PC 19-5503-15 15.0cm  
PC 19-5503-18 18.0cm  
PC 19-5503-24 24.0cm



1.0mm

PC 19-5504-18  
18.0cm

DEBAKEY-CUSHING



DEBAKEY-DIETRICH



1.0mm

PC 19-5505-15 15.0cm PC 19-5506-15  
PC 19-5505-19 19.0cm PC 19-5506-19  
PC 19-5505-24 24.0cm PC 19-5506-24



1.5mm



1.0mm



DEBAKEY-LIGHT

PC 19-5507-15 15.0cm  
PC 19-5507-19 19.0cm  
PC 19-5507-24 24.0cm

Atrauma Tissue Forceps ●— EN  
 Atrauma Pinzetten ●— DE  
 Pinzas de disección Atraumaostáticas ●— ES

Also available in titanium

1.5 mm

**DE BAKEY**  
 PC 19-5508-16 16.0cm  
 PC 19-5508-20 20.0cm  
 PC 19-5508-24 24.0cm  
 PC 19-5508-30 30.0cm

2.0 mm

**DE BAKEY**  
 PC 19-5509-16 16.0cm  
 PC 19-5509-20 20.0cm  
 PC 19-5509-24 24.0cm  
 PC 19-5509-30 30.0cm

2.7 mm

**DE BAKEY**  
 PC 19-5510-16 16.0cm  
 PC 19-5510-20 20.0cm  
 PC 19-5510-24 24.0cm  
 PC 19-5510-30 30.0cm

3.5mm

**DE BAKEY**  
 PC 19-5511-16 16.0cm  
 PC 19-5511-20 20.0cm  
 PC 19-5511-24 24.0cm  
 PC 19-5511-30 30.0cm

2mm

**DE BAKEY**  
 PC 19-5512-16 16.0cm  
 PC 19-5512-20 20.0cm  
 PC 19-5512-24 24.0cm  
 PC 19-5512-30 30.0cm

2.7mm

**DE BAKEY**  
 PC 19-5513-16 16.0cm  
 PC 19-5513-20 20.0cm  
 PC 19-5513-24 24.0cm  
 PC 19-5513-30 30.0cm

- EN —● Atrauma Bulldog Clamps
- DE —● Atrauma Bulldogklemmen
- ES —● Atrauma Clamps Bulldog

Also available in titanium

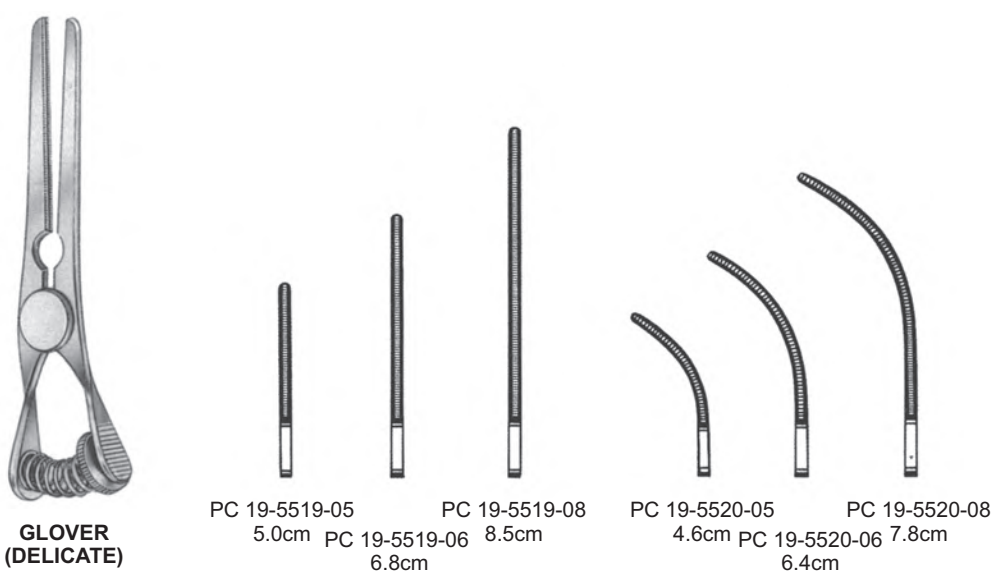
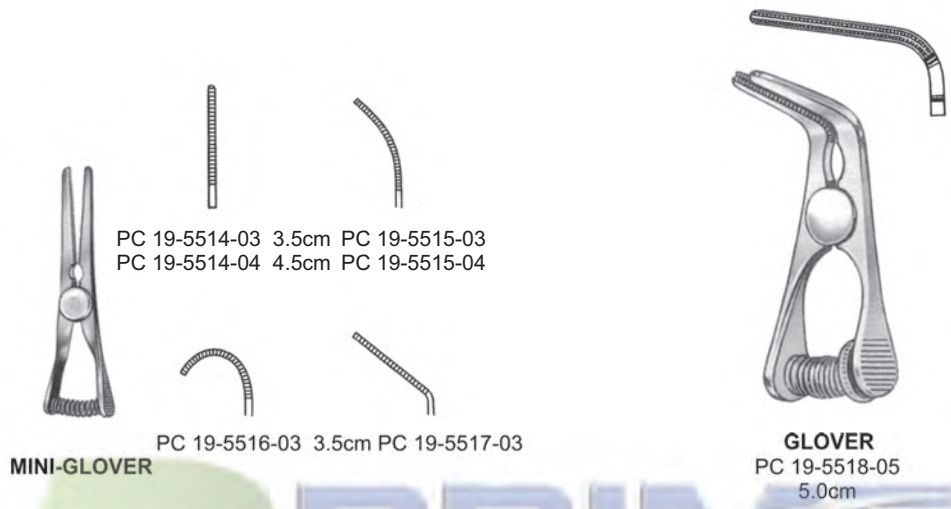



- Atrauma Bulldog Clamps ●— EN
- Atrauma Bulldogklemmen ●— DE
- Atrauma Clamps Bulldog ●— ES

Also available in titanium

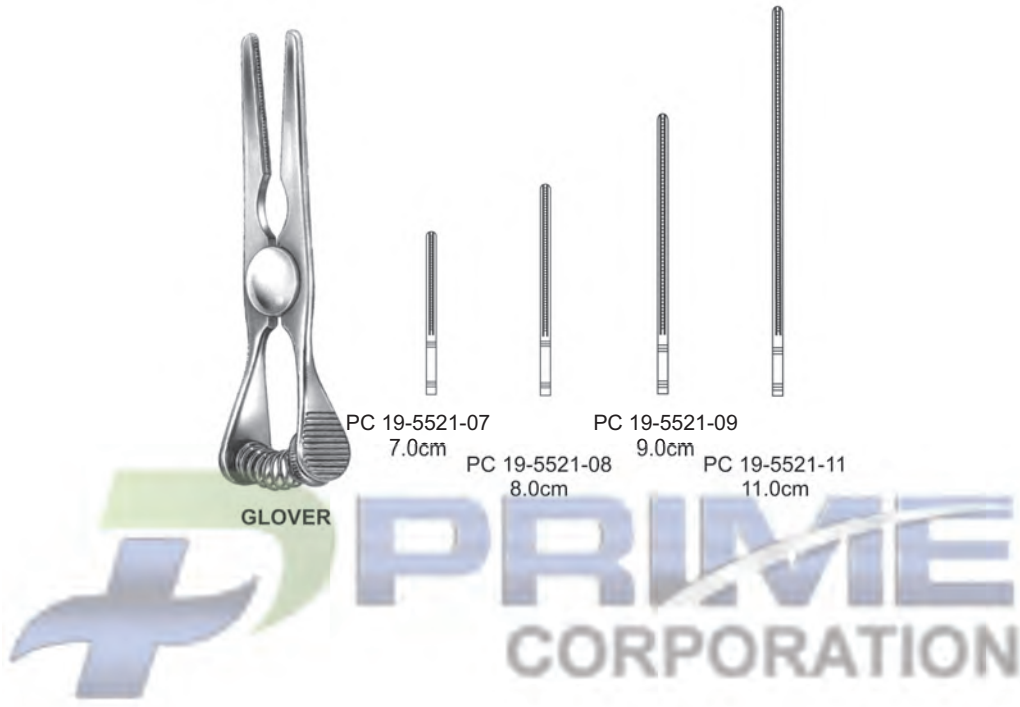

- EN —● Atrauma Bulldog Clamps
- DE —● Atrauma Bulldogklemmen
- ES —● Atrauma Clamps Bulldog

Also available in titanium

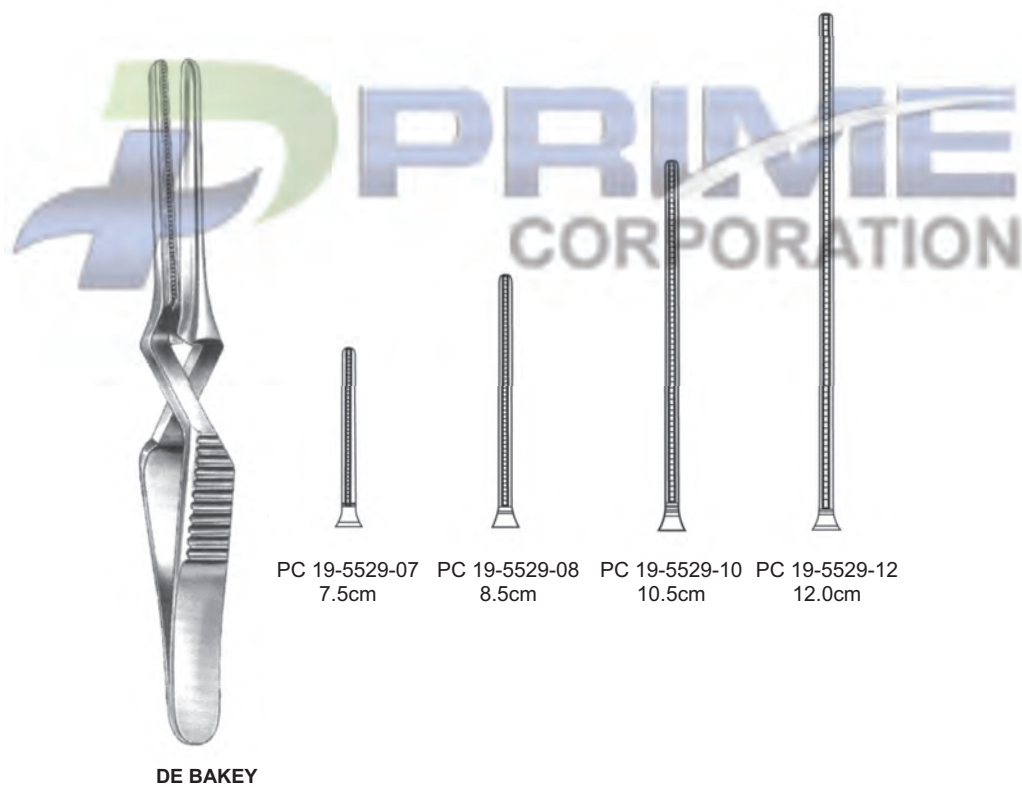

- Atrauma Bulldog Clamps ●— EN
- Atrauma Bulldogklemmen ●— DE
- Atrauma Clamps Bulldog ●— ES

Also available in titanium

DE BAKEY

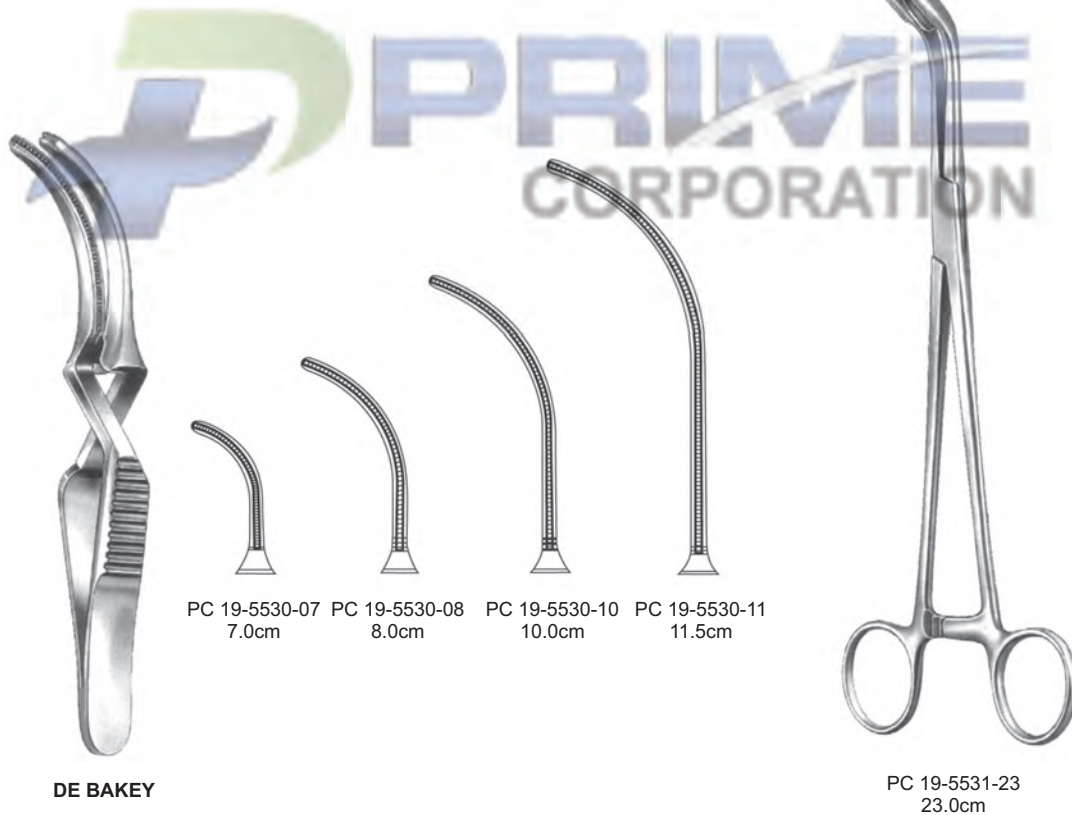

DE BAKEY

PC 19-5531-23  
23.0cm

- EN —● Atrauma Bulldog Clamps
- DE —● Atrauma Bulldogklemmen
- ES —● Atrauma Clamps Bulldog

Also available in titanium



GREGORY SOFT

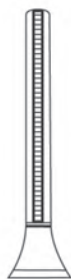

PC 19-5532-09  
9.0cm

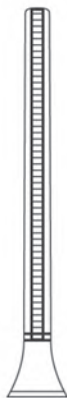

PC 19-5532-11  
11.0cm



GREGORY SOFT

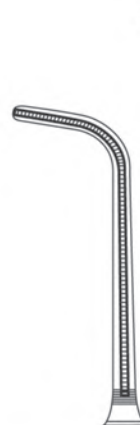

PC 19-5533-09  
9.0cm

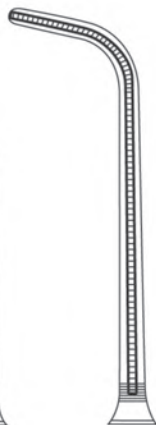

PC 19-5533-11  
11.0cm



GREGORY SOFT  
11.0cm



PC 19-5534-01



PC 19-5534-02



SANTULLI  
PC 19-5535-07  
7.0cm

- Atrauma Bulldog Clamps ● EN
- Atrauma Bulldogklemmen ● DE
- Atrauma Clamps Bulldog ● ES

Also available in titanium



**DE BAKEY-SATINSKY**  
PC 19-5536-07  
7.0cm

**DE BAKEY-SATINSKY**  
PC 19-5537-10  
10.0cm

**DE BAKEY-CAROTIS**  
PC 19-5538-09  
9.0cm



- EN —● Atrauma Cardiovascular Forceps
- DE —● Atrauma cardiovascular-klemmen
- ES —● Atrauma cardiovasculaire Forceps



- Atrauma Cardiovascular Forceps ● EN
- Atrauma cardiovascular-klemmen ● DE
- Atrauma pinzas-clamps cardiovasculares ● ES

Dissecting and  
Ligature Forceps



De Bakey

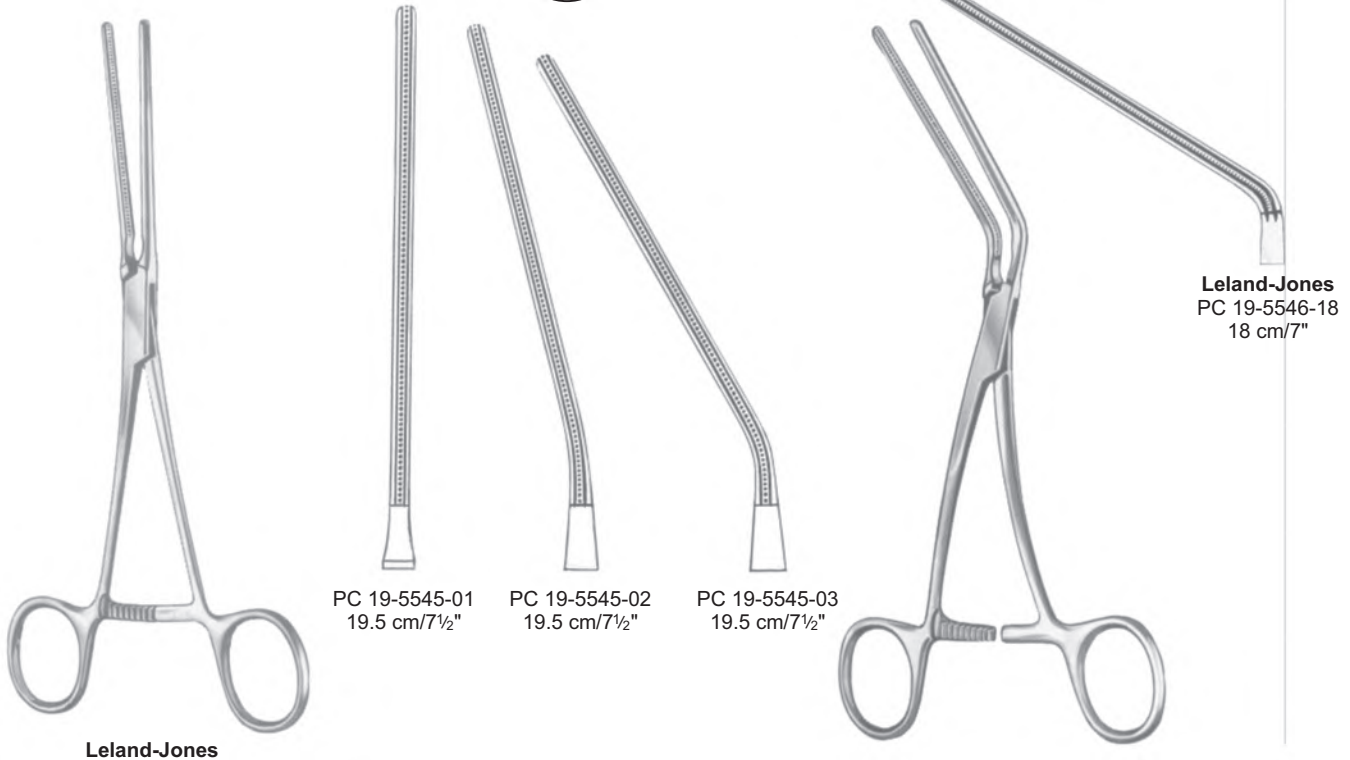

- EN —● Atrauma Cardiovascular Forceps
- DE —● Atrauma cardiovascular-klemmen
- ES —● Atrauma cardiovasculaire Forceps



De Bakey

Aortic Aneurysm Clamps



De Bakey



- PC 19-5547-24 26 cm/10 1/2"
- PC 19-5547-27 27 cm/10 1/2"
- PC 19-5547-31 31 cm/12 1/4"
- PC 19-5547-33 33 cm/13 1/4"



De Bakey-Bainbirdge



- PC 19-5548-15 15 cm/6"
- PC 19-5548-18 18 cm/7"
- PC 19-5549-15 15 cm/6"
- PC 19-5549-18 18 cm/7"



De Bakey  
PC 19-5549-20  
20 cm/8"

- Atrauma Cardiovascular Forceps ● EN
- Atrauma cardiovascular-klemmen ● DE
- Atrauma pinzas-clamps cardiovasculares ● ES



De Bakey

Aortic Aneurysm Clamps

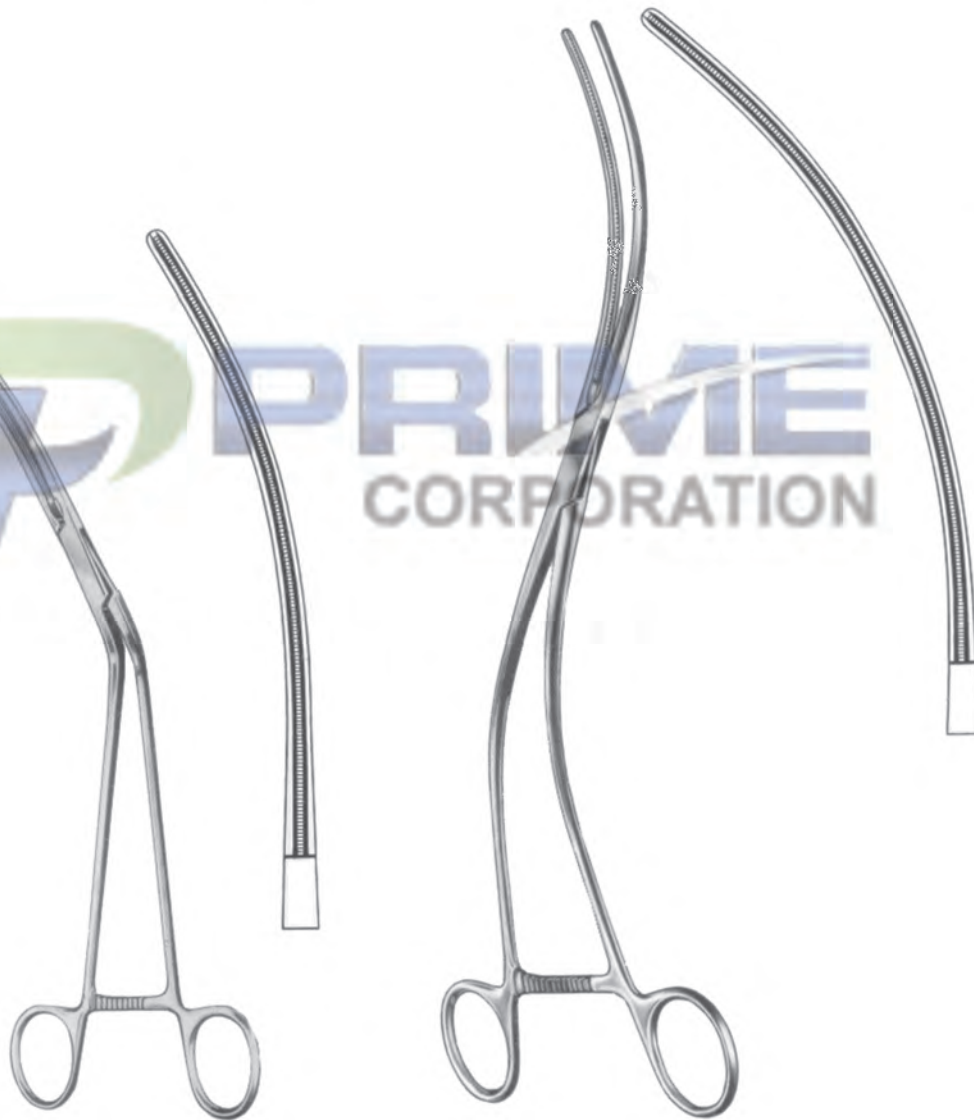

**De Bakey**  
PC 19-5550-28  
28 cm/11"

PC 19-5551-30  
30 cm/12"

- EN —● Atrauma Cardiovascular Forceps  
 DE —● Atrauma cardiovascular-klemmen  
 ES —● Atrauma cardiovasculaire Forceps



De Bakey

Aortic Clamps



**Ochsner**  
 PC 19-5552-23  
 23.5 cm/9¼"

**Dietrich**  
 PC 19-5553-21  
 21 cm/8¼"



Atrauma Cardiovascular Forceps ●— EN  
 Atrauma cardiovascular-klemmen ●— DE  
 Atrauma pinzas-clamps cardiovasculares ●— ES



De Bakey



PC 19-5554-01  
24 cm/9½"



PC 19-5554-02  
24 cm/9½"

Auricle Clamp



Harken



PC 19-5554-03  
24 cm/9½"



PC 19-5554-04  
24 cm/9½"

- EN —● Atrauma Cardiovascular Forceps
- DE —● Atrauma cardiovascular-klemmen
- ES —● Atrauma cardiovasculaire Forceps



De Bakey

Bronchus Clamps

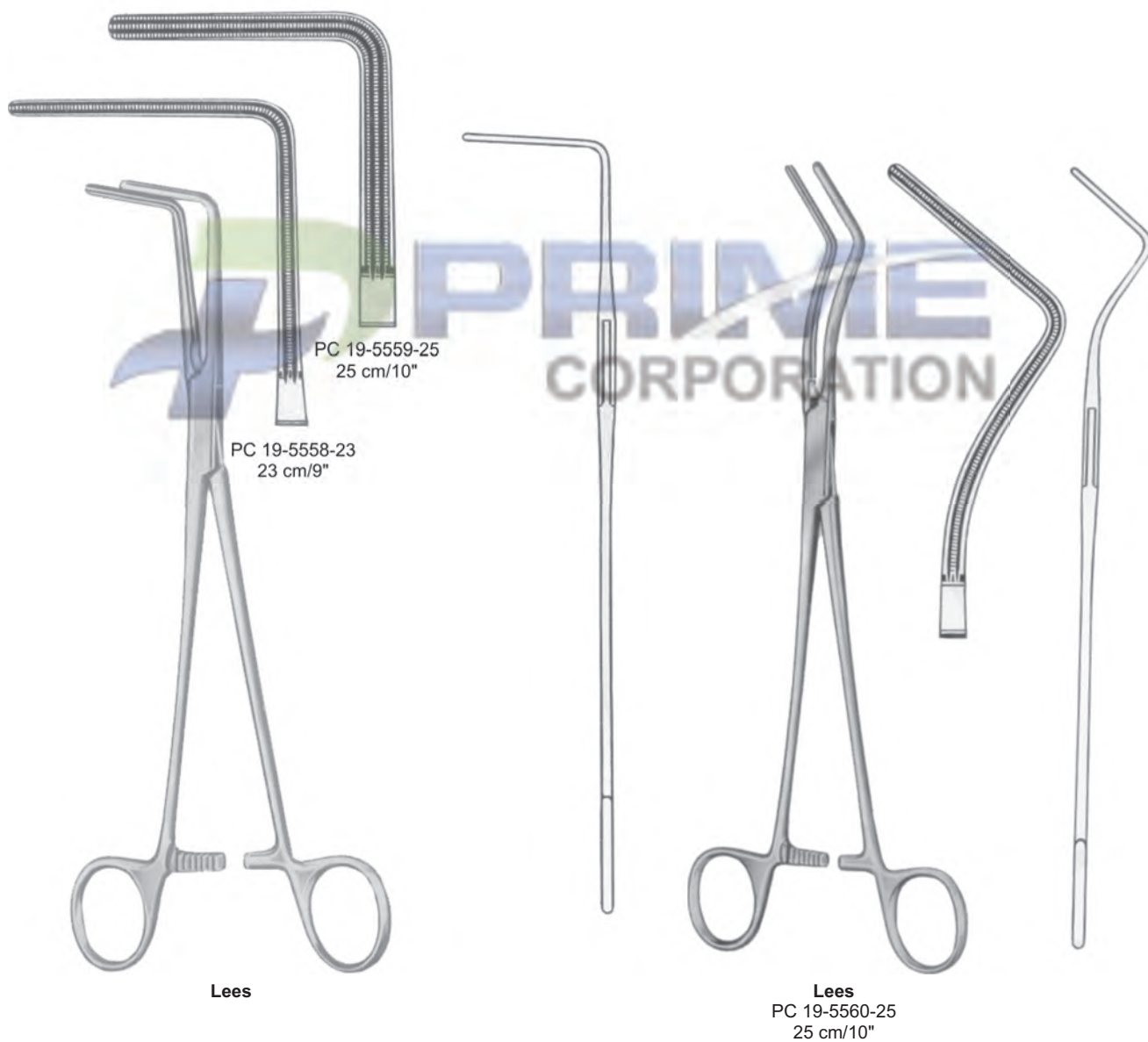

Lees

Lees  
PC 19-5560-25  
25 cm/10"

- Atrauma Cardiovascular Forceps ●— EN
- Atrauma cardiovascular-klemmen ●— DE
- Atrauma pinzas-clamps cardiovasculares ●— ES



De Bakey

Aortic Clamp

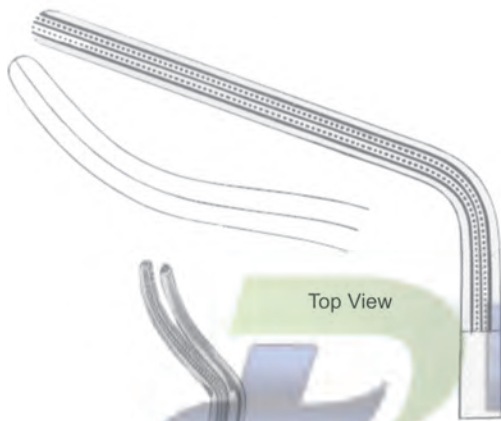

Top View

Ligature Clamps



**De Bakey**  
 PC 19-5561-27  
 27 cm/10½"

**De Bakey**  
 PC 19-5562-24  
 24 cm/9½"

**De Bakey**  
 PC 19-5563-24  
 24 cm/9½"

- EN —● Atrauma Cardiovascular Forceps
- DE —● Atrauma cardiovascular-klemmen
- ES —● Atrauma pinzas-clamps cardiovasculares



De Bakey

Ligature clamp,  
Aortic clamp

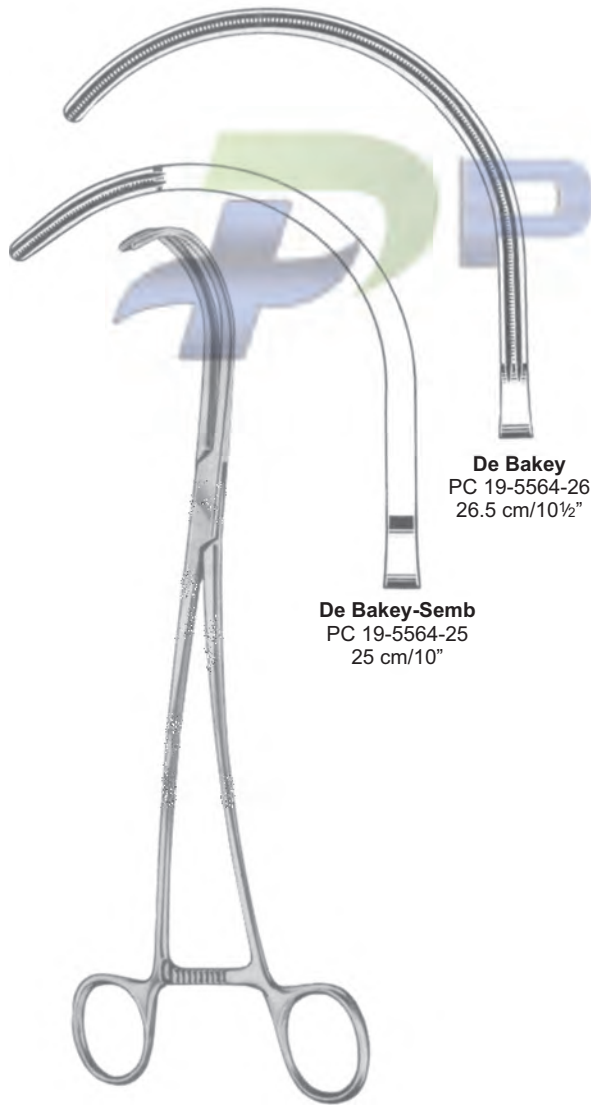

PC 19-5565-02

PC 19-5565-01

**De Bakey**  
PC 19-5564-26  
26.5 cm/10½"

**De Bakey-Semb**  
PC 19-5564-25  
25 cm/10"

**De Bakey-Semb**

Aortic clamp

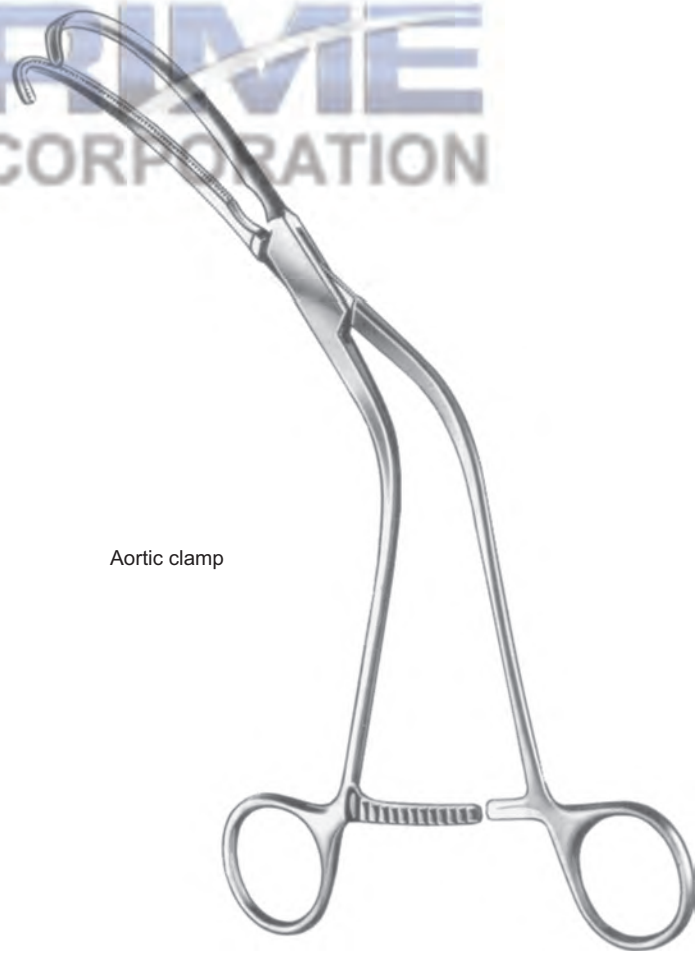

**Weber**  
26 cm/10¼"

Atrauma Cardiovascular Forceps ●— EN  
 Atrauma cardiovascular-klemmen ●— DE  
 Atrauma pinzas-clamps cardiovasculares ●— ES



**Satinsky/De Bakey**

Tangential occlusion clamps

Set of 5 purchase.  
PC 19-5568-00

PC 19-5568-20  
20 cm/8"

PC 19-5568-25  
25 cm/10"

PC 19-5568-26  
26 cm/10¼"

PC 19-5568-27  
27 cm/10½"

PC 19-5568-28  
28 cm/11"



De Bakey

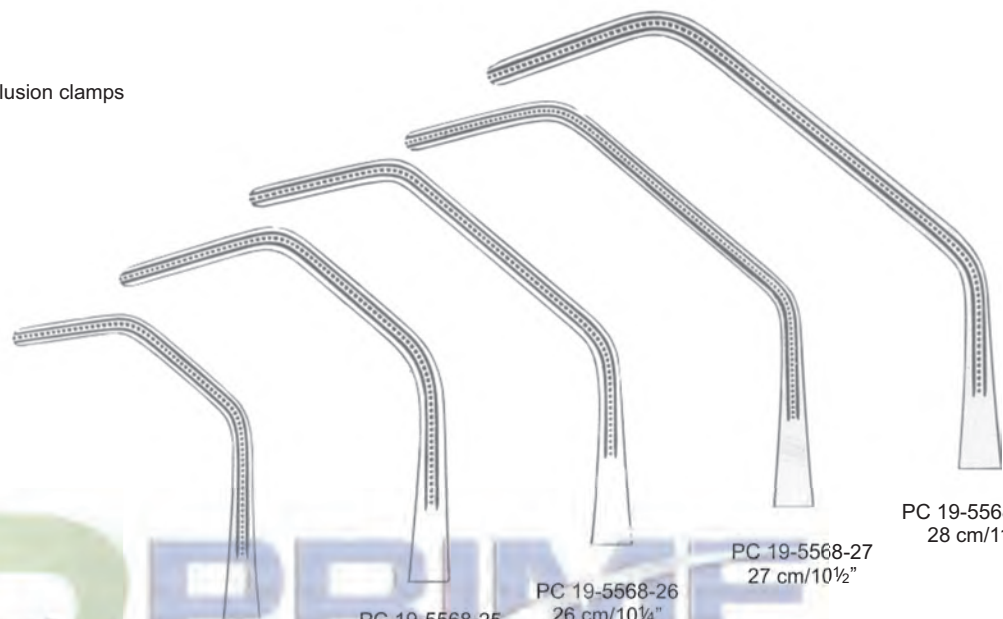

**Glover**

PC 19-5569-01 19.5 cm/7¾"  
 PC 19-5569-02 21.0 cm/8¼"

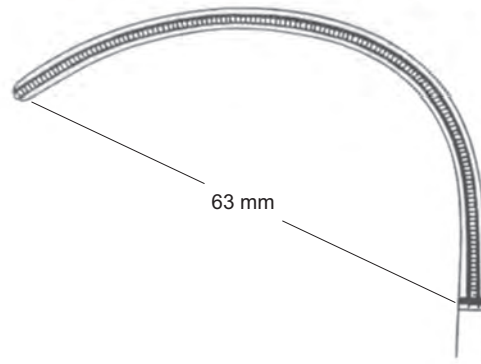

Anastomosis

63 mm

PC 19-5569-01

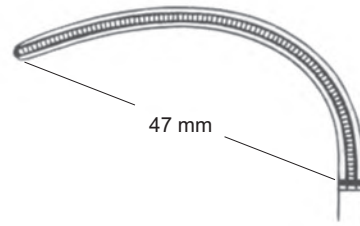

47 mm

PC 19-5569-02



- EN —● Atrauma Cardiovascular Forceps
- DE —● Atrauma cardiovascular-klemmen
- ES —● Atrauma pinzas-clamps cardiovasculares



De Bakey



**De Bakey**  
PC 19-5570-16  
16 cm/6 1/4"



Graduated



**De Bakey-Beck**  
PC 19-5571-01 20.5 cm/8"  
PC 19-5571-02 21.0 cm/8 1/4"

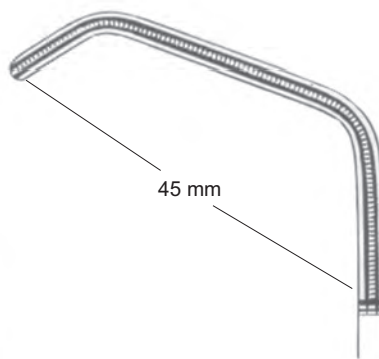

45 mm

PC 19-5571-02

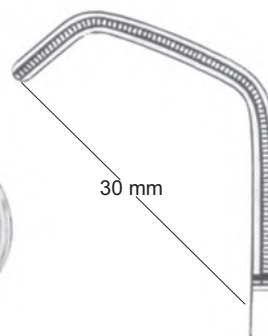

30 mm

PC 19-5571-01

- Atrauma Cardiovascular Forceps ● EN
- Atrauma cardiovascular-klemmen ● DE
- Atrauma pinzas-clamps cardiovasculares ● ES



De Bakey



**Lambert-Kay**  
21 cm/8¼"



Aortic anastomosis clamps

PC 19-5572-22



**De Bakey**  
PC 19-5573-17  
17 cm/6¾"



**Beck**  
PC 19-5574-17  
17 cm/6¾"



- EN —● Atrauma Cardiovascular Forceps
- DE —● Atrauma cardiovascular-klemmen
- ES —● Atrauma pinzas-clamps cardiovasculares

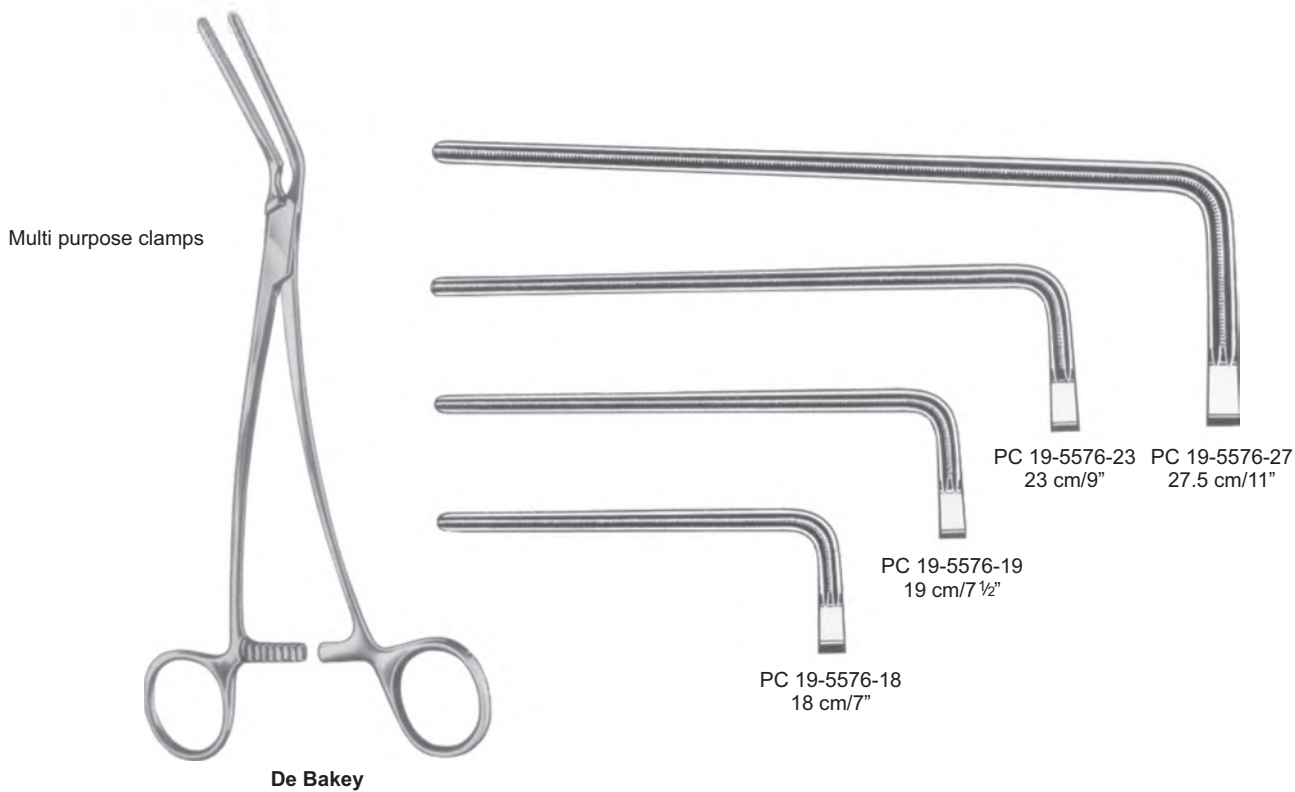
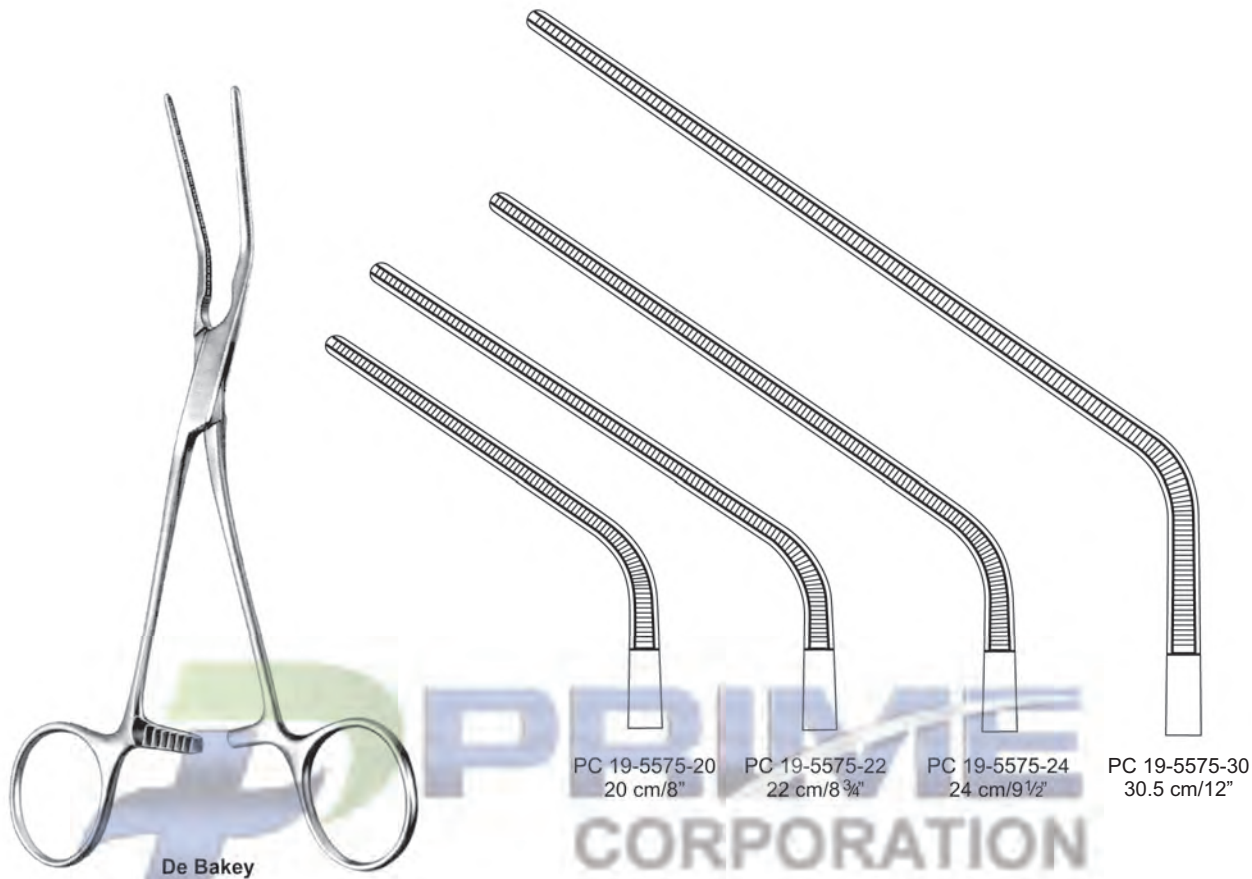

- Atrauma Cardiovascular Forceps ● EN
- Atrauma cardiovascular-klemmen ● DE
- Atrauma pinzas-clamps cardiovasculares ● ES

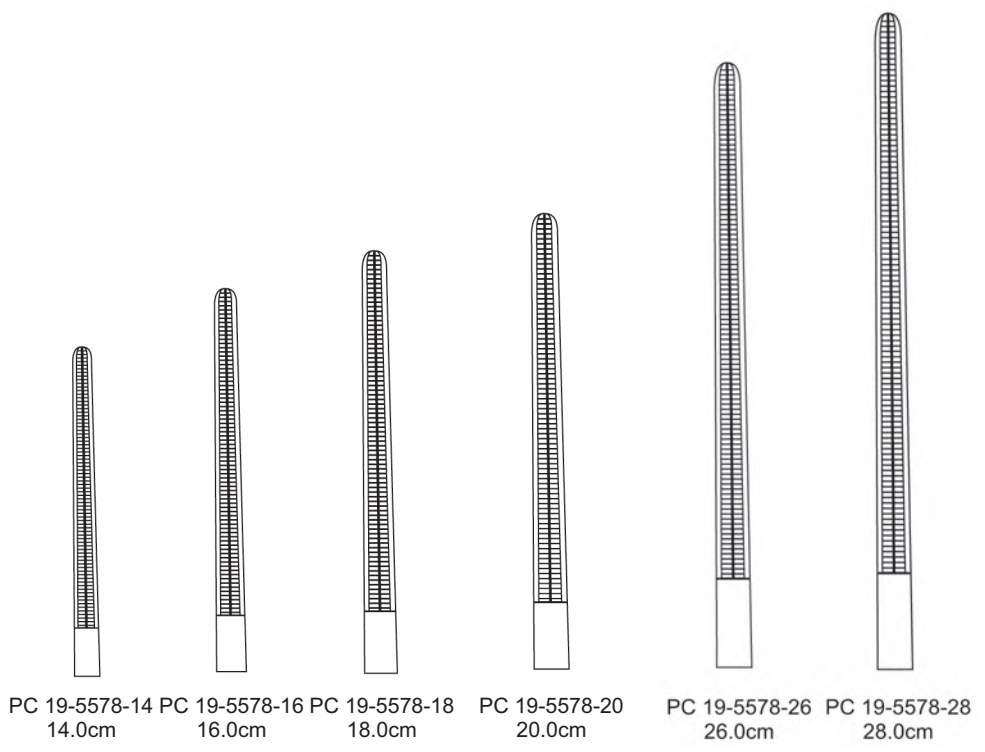
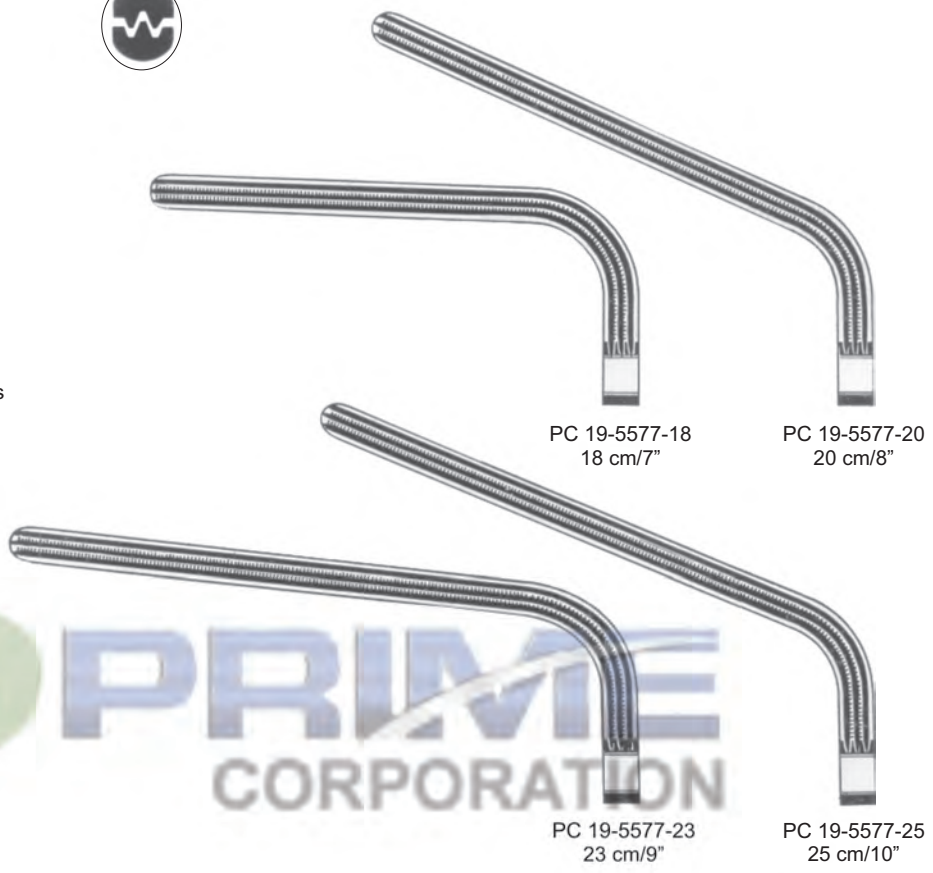



- EN —● Atrauma Cardiovascular Forceps
- DE —● Atrauma cardiovascular-klemmen
- ES —● Atrauma pinzas-clamps cardiovasculares

Aorta aneurysm clamps



De Bakey



De Bakey-Bahnson



PC 19-5579-23  
23 cm/9"

PC 19-5579-24  
24 cm/9½"

PC 19-5579-25  
25 cm/10"



DE BAKEY-PEAN

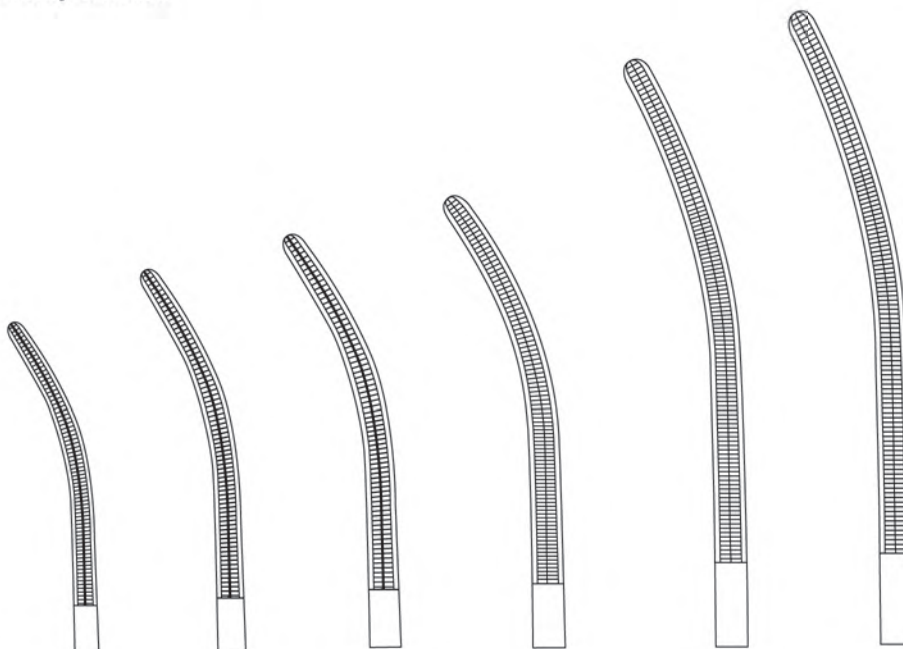

PC 19-5580-14  
14.0cm

PC 19-5580-16  
16.0cm

PC 19-5580-18  
18.0cm

PC 19-5580-20  
20.0cm

PC 19-5580-26  
26.0cm

PC 19-5580-28  
28.0cm



- Atrauma Cardiovascular Forceps ● EN
- Atrauma cardiovascular-klemmen ● DE
- Atrauma pinzas-clamps cardiovasculares ● ES

Multi purpose clamps



De Bakey



**De Bakey-Rankin**

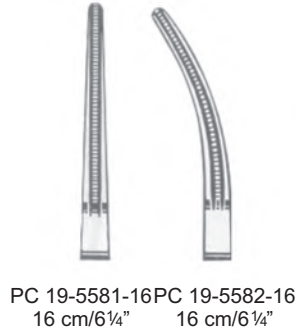

PC 19-5581-16 16 cm/6¼"  
PC 19-5582-16 16 cm/6¼"



**Cooley**



PC 19-5583-16  
16 cm/6¼"

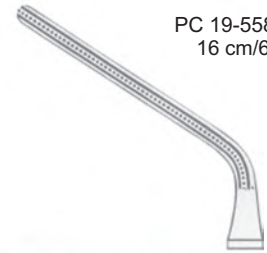

PC 19-5583-15  
15.5 cm/6"



PC 19-5583-14  
14.5 cm/5¾"



**De Bakey**  
PC 19-5584-17  
17 cm/6¾"

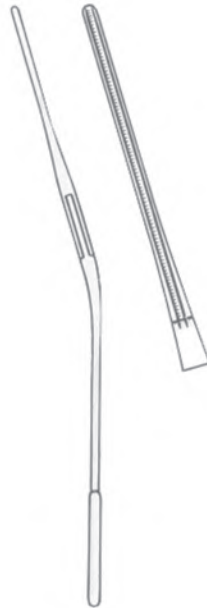

PC 19-5585-17



PC 19-5586-17



PC 19-5587-17

- EN —● Atrauma Cardiovascular Forceps
- DE —● Atrauma cardiovascular-klemmen
- ES —● Atrauma pinzas-clamps cardiovasculares



**De Bakey**

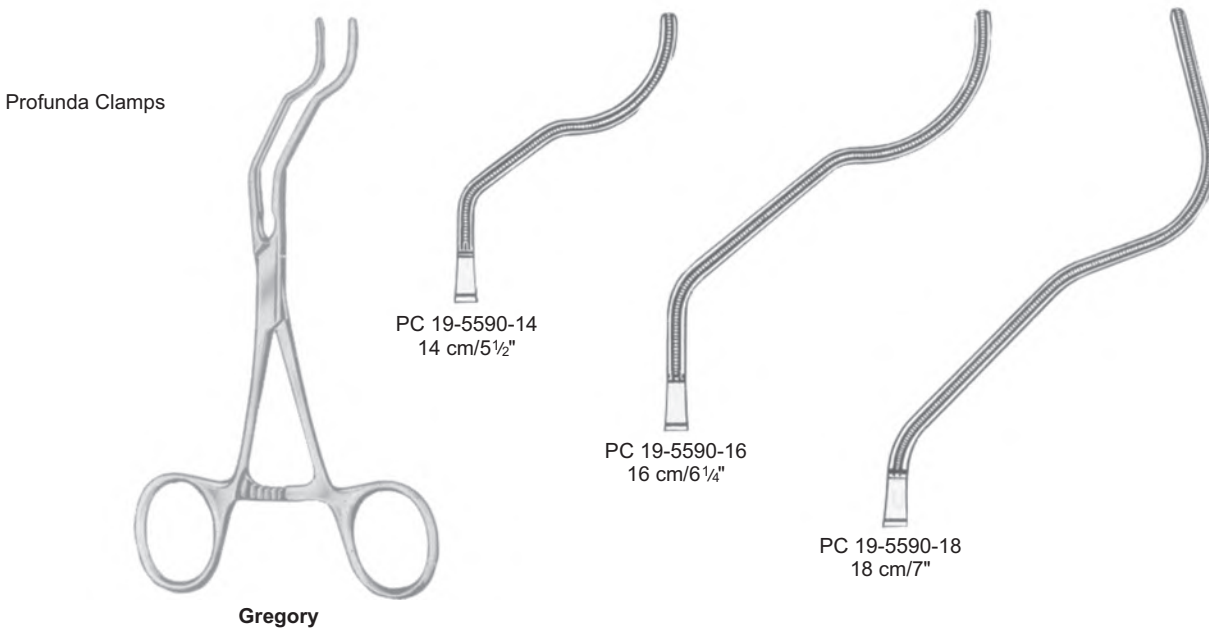

Atrauma Cardiovascular Forceps ●— EN  
 Atrauma cardiovascular-klemmen ●— DE  
 Atrauma pinzas-clamps cardiovasculares ●— ES



Cooley

Coarctation Clamps



**Cooley**  
 PC 19-5591-17  
 17 cm/6¾"

**Cooley**  
 PC 19-5592-17  
 17 cm/6¾"

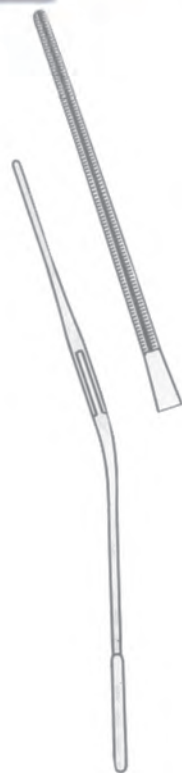

**Cooley**  
 PC 19-5593-17  
 17 cm/6¾"

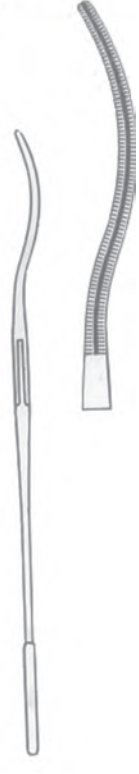

**Cooley**  
 PC 19-5594-17  
 17 cm/6¾"

- EN —● Atrauma Cardiovascular Forceps
- DE —● Atrauma cardiovascular-klemmen
- ES —● Atrauma pinzas-clamps cardiovasculares



**Cooley**



**Cooley**  
PC 19-5595-20  
20 cm/8"



**Cooley**

**Cooley**  
PC 19-5599-17  
17 cm/6 3/4"



PC 19-5596-03  
17 cm/6 3/4"



PC 19-5596-02  
15.5 cm/6"



PC 19-5596-01  
15 cm/6"



- Atrauma Cardiovascular Forceps ● EN
- Atrauma cardiovascular-klemmen ● DE
- Atrauma pinzas-clamps cardiovasculares ● ES

Anastomosis clamps



Cooley

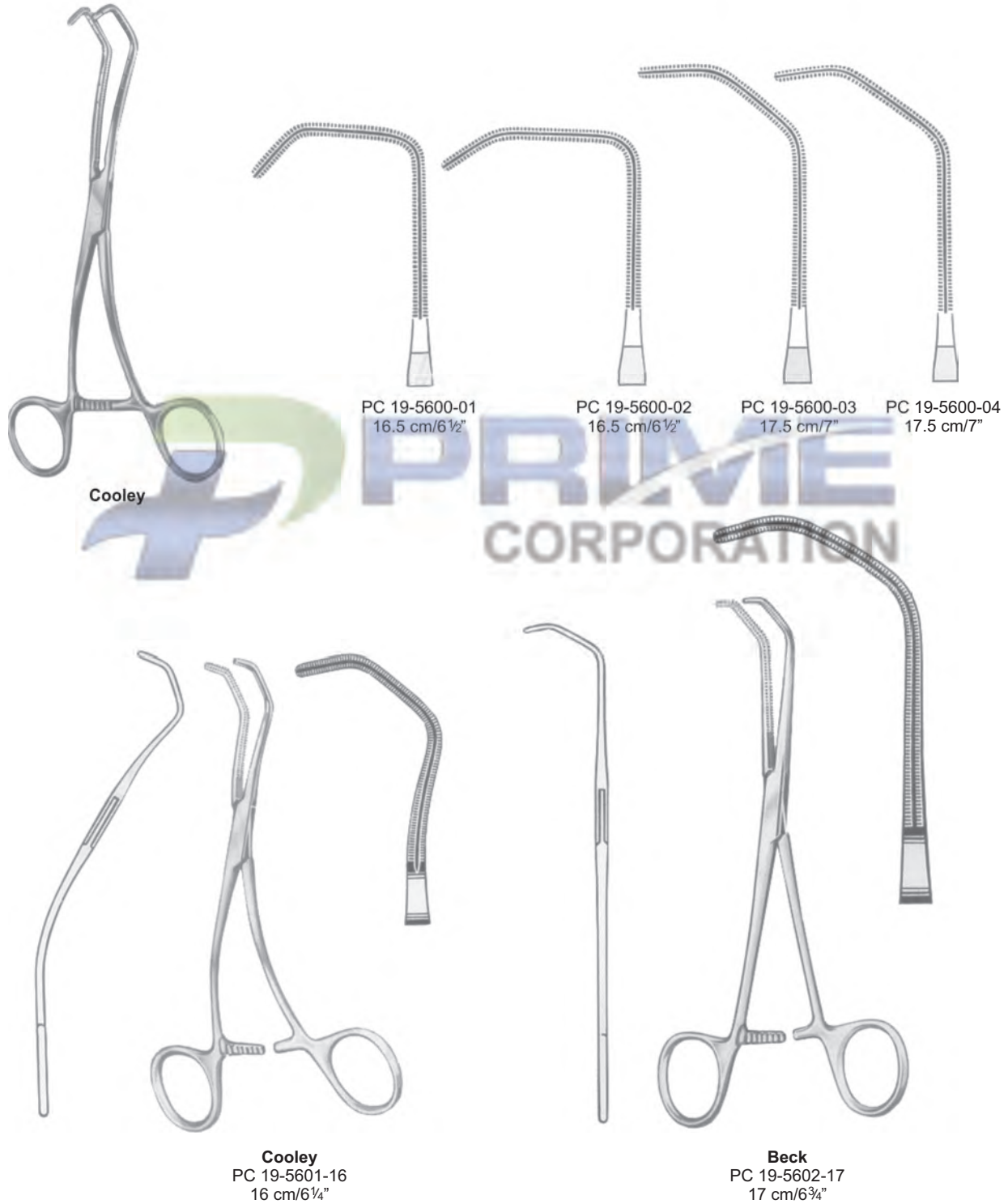



- EN —● Atrauma Cardiovascular Forceps
- DE —● Atrauma cardiovascular-klemmen
- ES —● Atrauma pinzas-clamps cardiovasculares

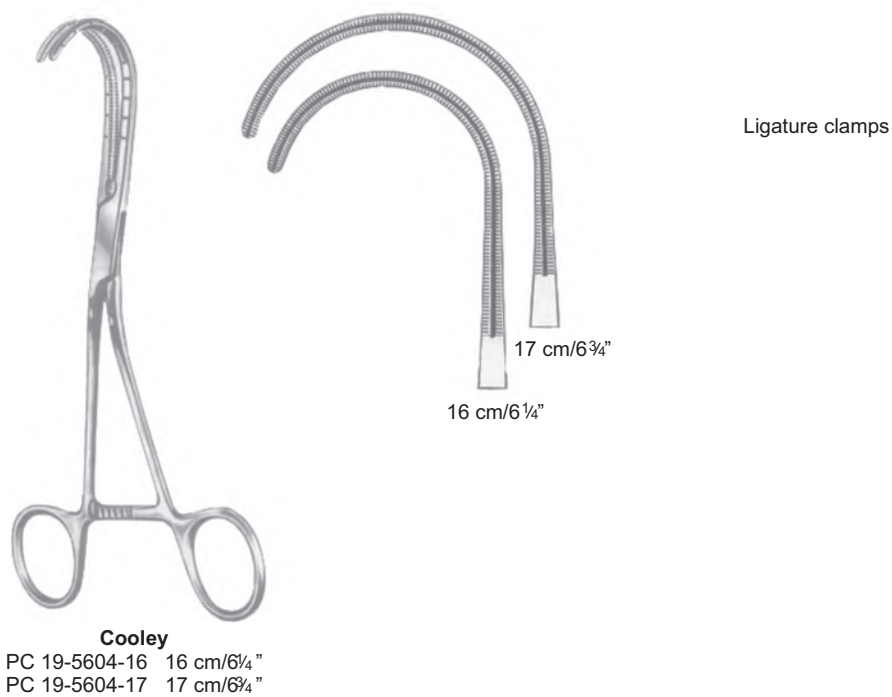

- Atrauma Cardiovascular Forceps ●— EN
- Atrauma cardiovascular-klemmen ●— DE
- Atrauma pinzas-clamps cardiovasculares ●— ES

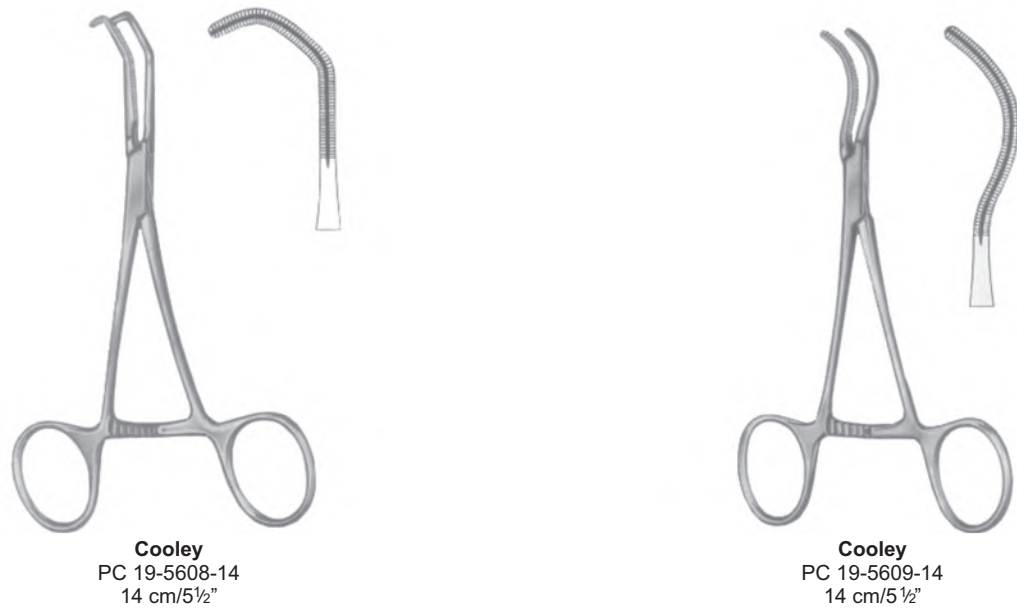

- EN —● Suction Tubes and Tourniquets
- DE —● Saugrohre und Tourniquets
- ES —● Los tubos de succión y torniquetes



blade opening from 8 to 42 mm

**TUBBS**  
PC 19-5610-42

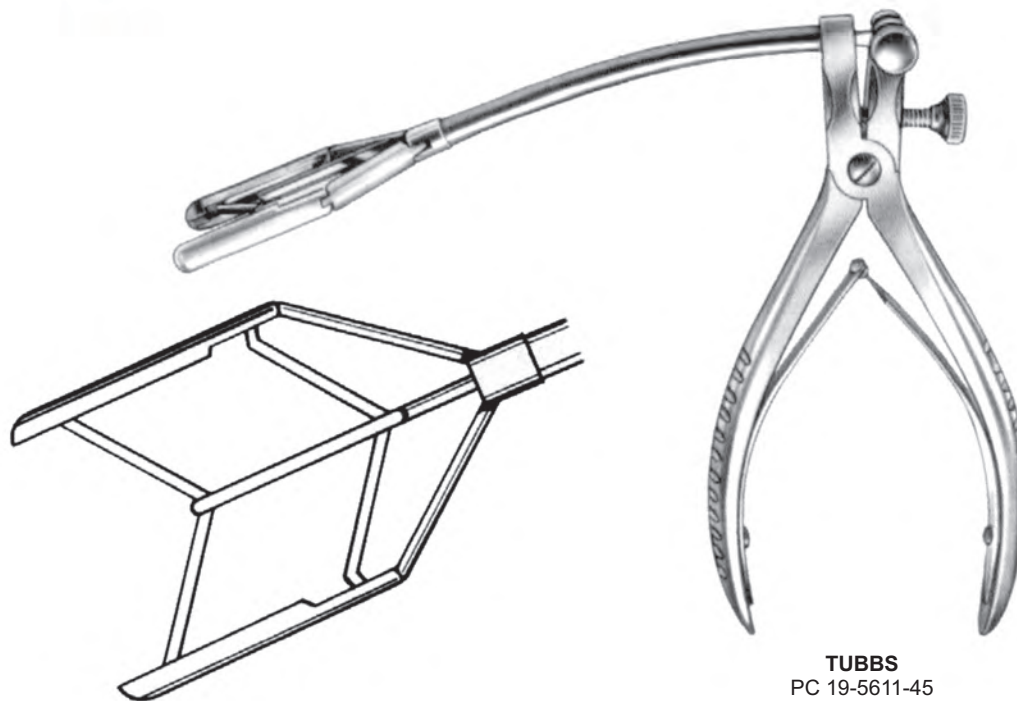

blade opening from 9 to 45 mm

**TUBBS**  
PC 19-5611-45

- Dilators ● — EN
- Dilatatoren ● — DE
- Dilatadores ● — ES

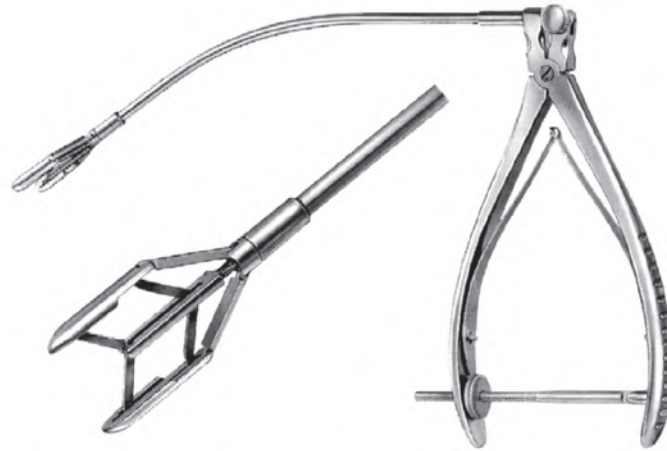

blade opening from 8 to 15 mm  
blade opening from 8 to 45 mm

**COOLEY**  
PC 19-5612-15  
PC 19-5612-45

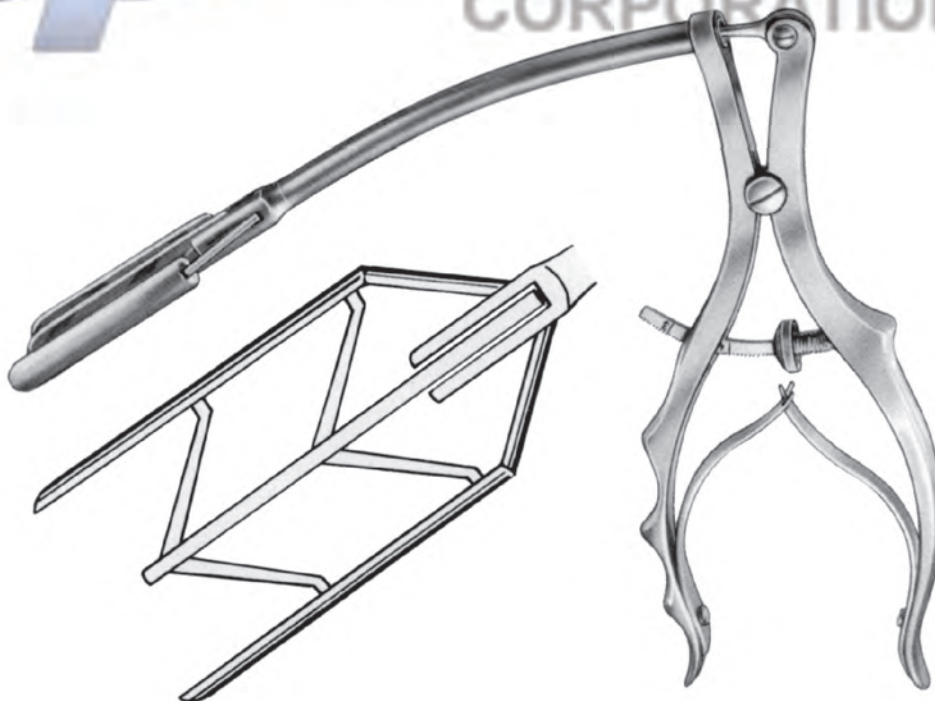

**COOLEY**  
PC 19-5613-40  
blade opening 9 - 40mm

**COOLEY-DEBAKEY**  
PC 19-5614-30  
blade opening 7 - 30mm

- EN —● Suction Tubes and Tourniquets  
DE —● Saugrohre und Tourniquets  
ES —● Los tubos de succión y torniquetes

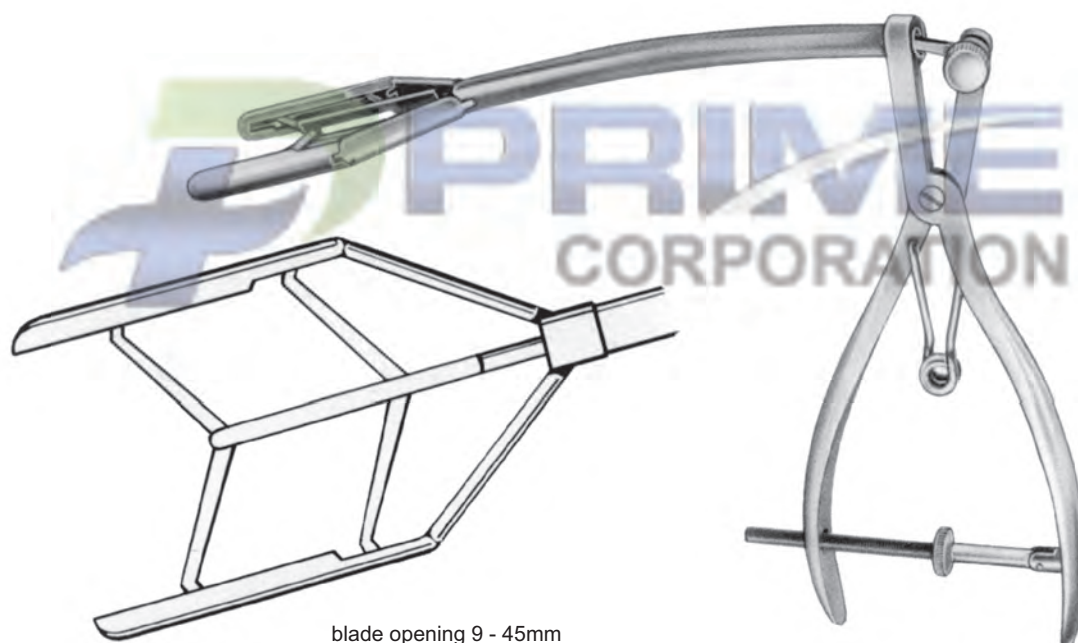

blade opening 9 - 45mm

**GERBODE**  
PC 19-5615-45



- Dilators ● — EN
- Dilatatoren ● — DE
- Dilatadores ● — ES



Blade opening 4 - 10mm



**HETZER**  
PC 19-5616-10

**COOLEY** blade opening  
PC 19-5617-18 5 - 18mm  
PC 19-5617-20 6 - 20mm

EN —● Vascular Dilators  
 DE —● Gefäß-Dilatatoren  
 ES —● Dilatadores vasculares

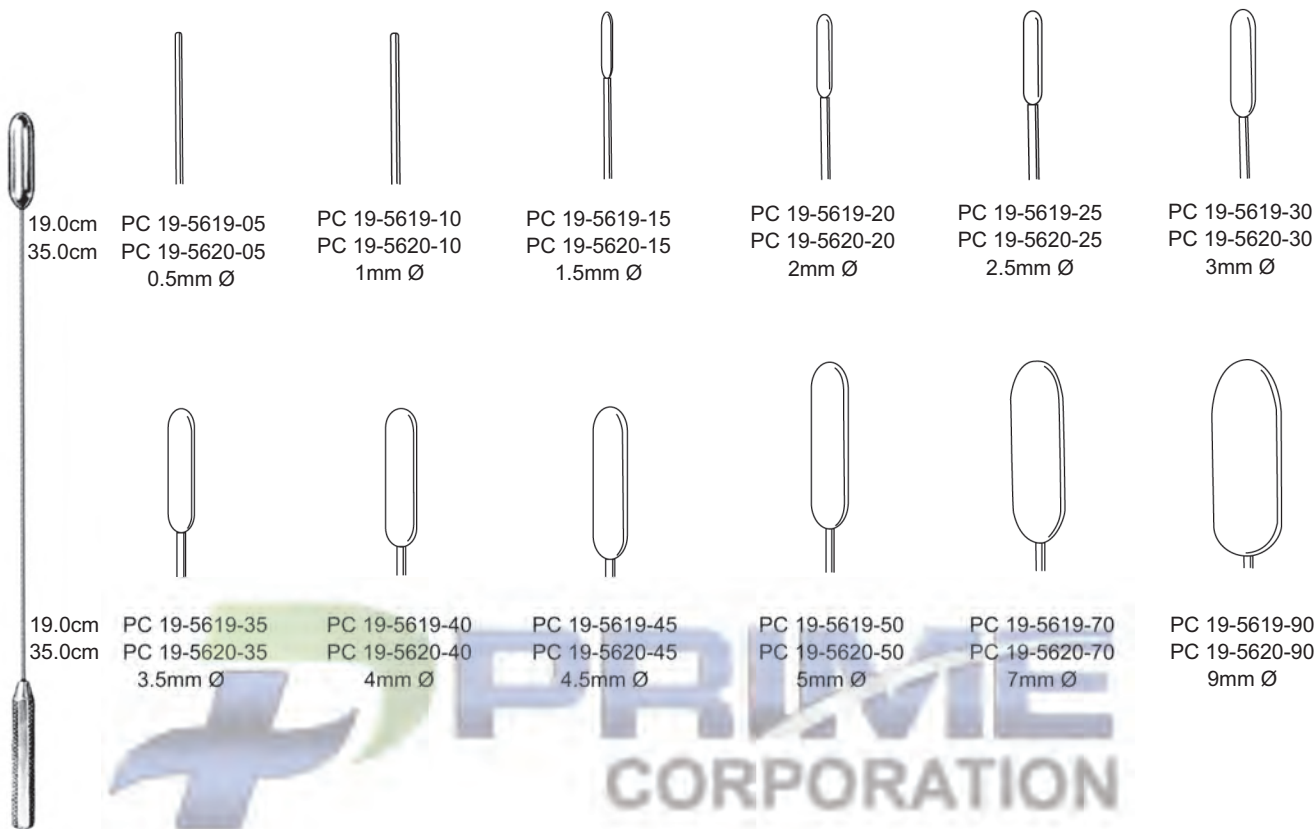

DE BAKEY

Malleable

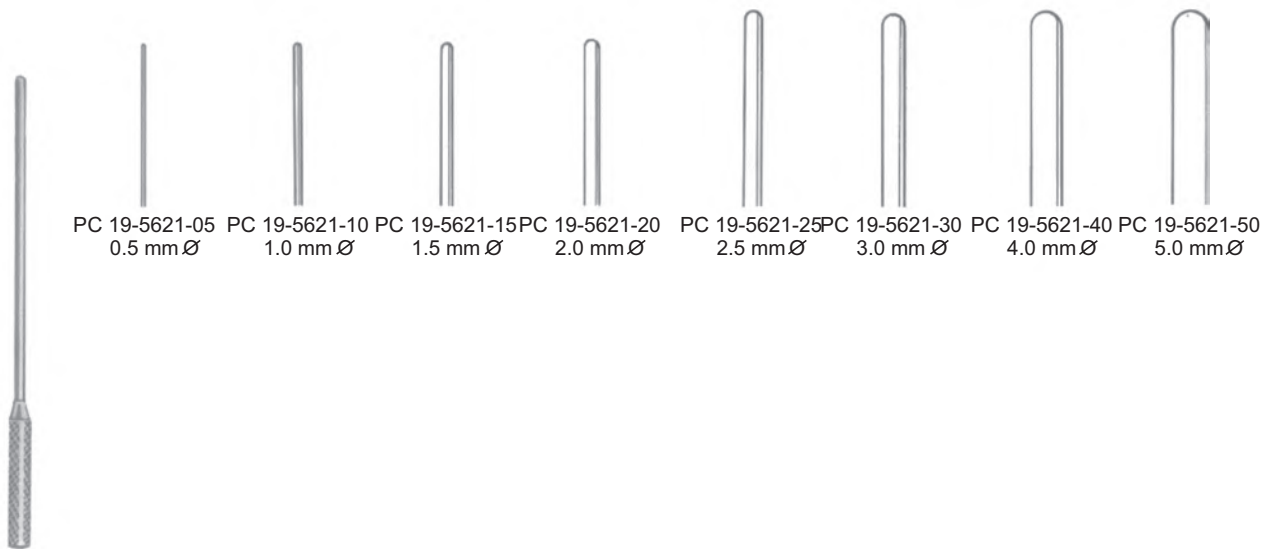

Cooley  
13 cm/5"

Rib Shears, Sternum Scissors and Sternum Chisels ●— EN  
 Rippenscheren, Sternumschere, Sternummeißel ●— DE  
 Costótomos, Tijera de esternón, cincel de esternón ●— ES



**Sauerbruch**  
 PC 19-5622-26  
 26 cm/10¼"



**Giertz-Stille**  
 PC 19-5623-27  
 27 cm/10½"

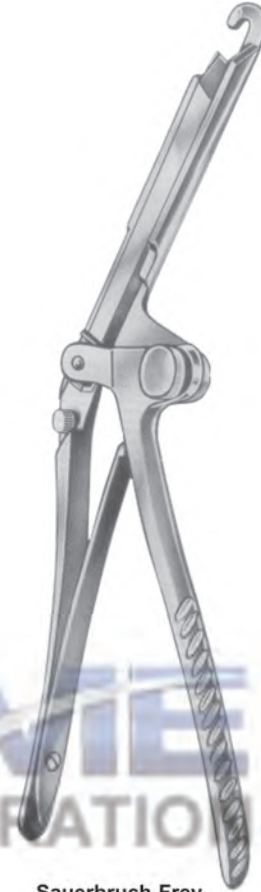

**Sauerbruch-Frey**  
 PC 19-5624-36  
 36 cm/14"



**Bethune**  
 PC 19-5625-34  
 34 cm/13½"

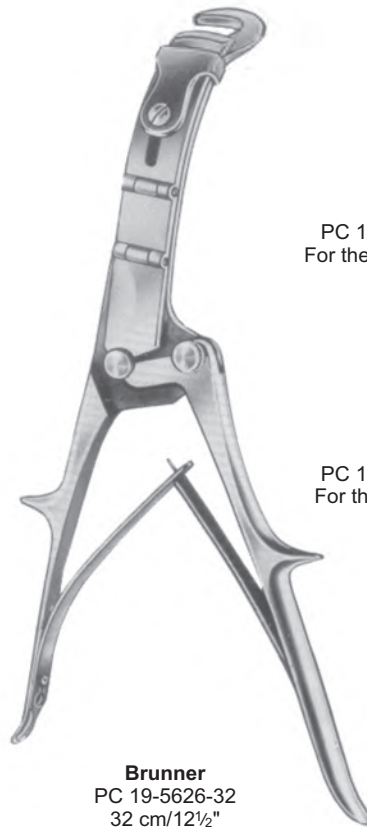

**Brunner**  
 PC 19-5626-32  
 32 cm/12½"

PC 19-5626-32  
 For the Right Hand

PC 19-5627-32  
 For the left Hand



**Lebsche**  
 PC 19-5628-24  
 24.5 cm/9¾"

- EN —● Bone and Rib Shears  
DE —● Knochen-und Rippenscheren  
ES —● Cizallas para huesos



**CORYLLOS**  
PC 19-5629-35  
35.0cm



**DOYEN**  
PC 19-5630-19  
19.0cm

- Bone and Rib Shears ● EN
- Knochen-und Rippenscheren ● DE
- Cizallas para huesos ● ES



**BETHUNE-NELSON**  
PC 19-5631-34  
34.0cm  
with probe ended blades



**ROBERTS**  
PC 19-5632-34  
34.0cm  
with angular probe ended blades



**ROBERTS**  
PC 19-5633-34  
34.0cm  
with angular probe ended  
blades of first and second ribs



- EN —● Bone and Rib Shears  
DE —● Knochen-und Rippenscheren  
ES —● Cizallas para huesos



**SCHUMACHER**  
PC 19-5634-20  
20.0cm

**TUDOR EDWARDS**  
PC 19-5635-23  
23.0cm

- Bone and Rib Shears ● EN
- Knochen-und Rippenscheren ● DE
- Cizallas para huesos ● ES



**LEBSCHE**  
PC 19-5636-25  
25.0cm

- EN —● Rib Spreaders
- DE —● Rippensperrer
- ES —● Separadores costales

Scheme of dimensions

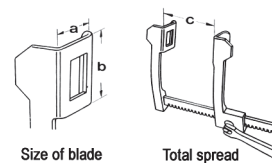

CASTAÑEDA		ALU	a	b	c
S/S	PC 19-5637-01	PC 19-5637-11	10.5mm	32mm	65mm
	PC 19-5637-02	PC 19-5637-12	16mm	30mm	65mm



CASTAÑEDA		ALU	a	b	c
S/S	PC 19-5638-01	PC 19-5638-11	12mm	45mm	70mm



CASTAÑEDA		ALU	a	b	c
S/S	PC 19-5639-01	PC 19-5639-11	15mm	60mm	120mm

- Rib Spreaders ●— EN
- Rippensperrer ●— DE
- Separadores costales ●— ES



**COOLEY**

S/S	ALU	a	b	c
PC 19-5640-01	PC 19-5640-11	12mm	16mm	95mm
PC 19-5640-02	PC 19-5640-12	12mm	17mm	75mm
PC 19-5640-03	PC 19-5640-13	14mm	16mm	85mm



**COOLEY**

S/S	ALU	a	b	c
PC 19-5641-01	PC 19-5641-11	15mm	30mm	115mm
PC 19-5641-02	PC 19-5641-12	15mm	30mm	140mm
PC 19-5641-03	PC 19-5641-13	16mm	30mm	105mm
PC 19-5641-04	PC 19-5641-14	20mm	45mm	140mm
PC 19-5641-05	PC 19-5641-15	21mm	44mm	150mm
PC 19-5641-06	PC 19-5641-16	30mm	35mm	140mm



**COOLEY**

S/S	ALU	a	b	c
PC 19-5642-01	PC 19-5642-11	30mm	50mm	185mm
PC 19-5642-02	PC 19-5642-12	35mm	50mm	200mm
PC 19-5642-03	PC 19-5642-13	37mm	49mm	200mm

- EN —● Rib Spreaders  
 DE —● Rippensperrer  
 ES —● Separadores costales

**COOLEY**

for neonatal

S/S	ALU	a	b	c
PC 19-5643-01	PC 19-5643-11	12mm	15mm	70mm

**COOLEY**

infant, sternal spreader

S/S	ALU	a	b	c
PC 19-5644-01	PC 19-5644-11	15mm	20mm	100mm



**COOLEY**

for babies

S/S	ALU	a	b	c
PC 19-5645-01	PC 19-5646-01	20mm	25mm	80mm

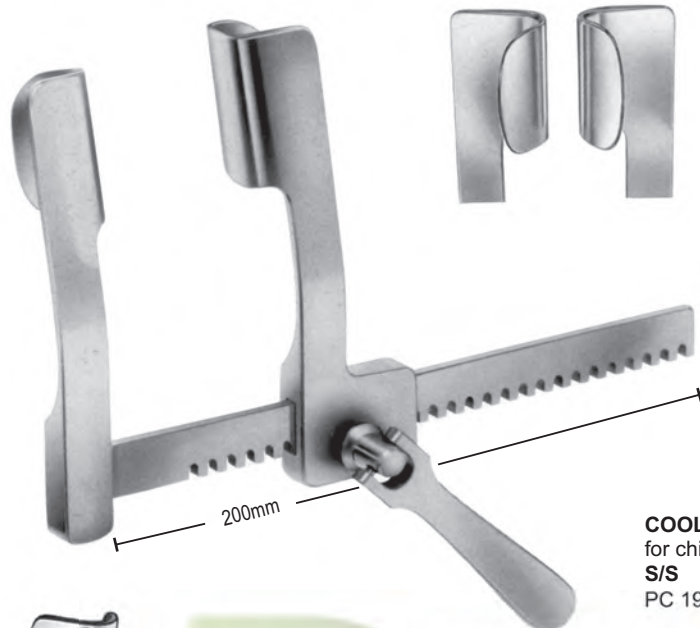

- Rib Spreaders ● EN
- Rippensperrer ● DE
- Senaradores costales ● ES



**COOLEY**  
for children  
S/S ALU a b c  
PC 19-5647-01 PC 19-5648-01 21mm 45mm 145mm

for adult  
PC 19-5647-02 PC 19-5648-02 32mm 50mm 190mm

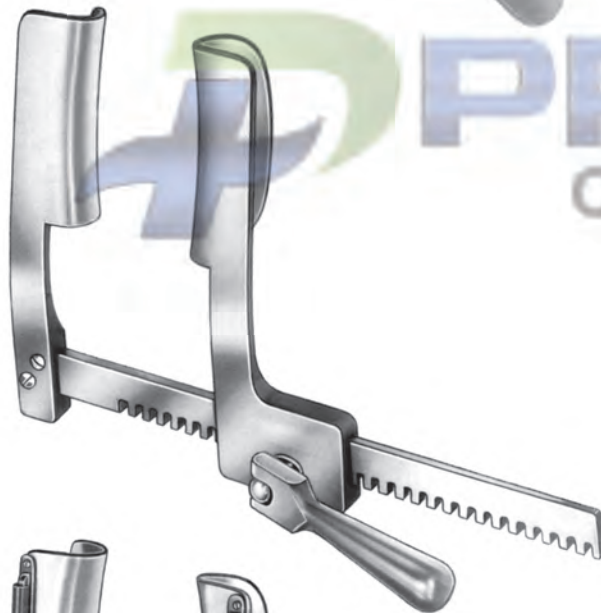

**COOLEY**  
for children  
S/S ALU a b c  
PC 19-5649-01 PC 19-5650-01 35mm 100mm 180mm

for adult  
PC 19-5649-02 PC 19-5650-02 35mm 115mm 230mm



**COOLEY**  
for adults with suture separator  
S/S ALU a b c  
PC 19-5651-01 PC 19-5652-01 35mm 100mm 180mm

- EN —● Rib Spreaders
- DE —● Rippensperrer
- ES —● Separadores costales



**H-COOLEY**  
with swivel convex blades, for babies  
**S/S**                    **ALU**                    **a**                    **b**                    **c**  
PC 19-5653-01    PC 19-5654-01    10mm    15mm    90mm



**H-COOLEY**  
with swivel blades, for babies  
**S/S**                    **ALU**                    **a**                    **b**                    **c**  
PC 19-5655-02    PC 19-5656-02    10mm    15mm    90mm

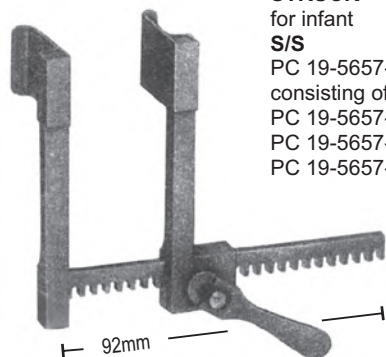

**STRUCK**  
for infant  
**S/S**                    **ALU**  
PC 19-5657-00    PC 19-5657-01  
consisting of  
PC 19-5657-90    spreader only  
PC 19-5657-04    1 pair  
PC 19-5657-05    1 pair

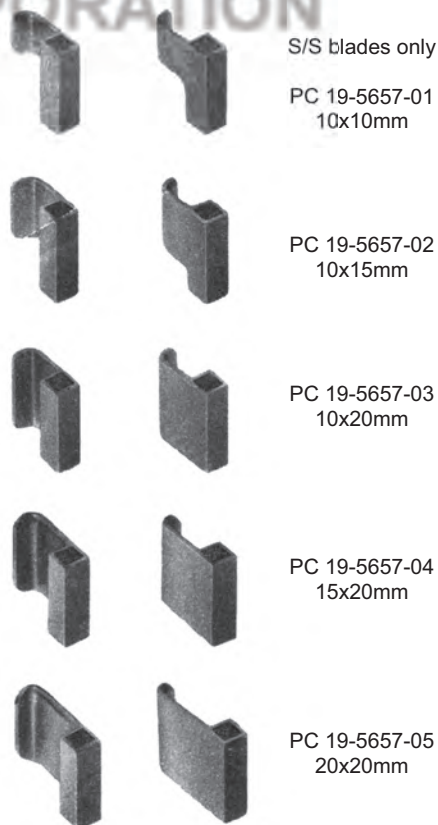

S/S blades only  
PC 19-5657-01  
10x10mm  
PC 19-5657-02  
10x15mm  
PC 19-5657-03  
10x20mm  
PC 19-5657-04  
15x20mm  
PC 19-5657-05  
20x20mm

- Rib Spreaders ●— EN
- Rippensperrer ●— DE
- Separadores costales ●— ES



**WEINBERG**  
for children

S/S	ALU	a	b	c
PC 19-5658-01	PC 19-5659-01	12mm	20mm	95mm

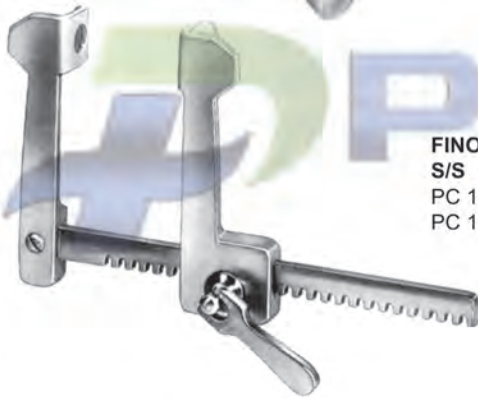

**FINOCHIETTO-INFANT**

S/S	ALU	a	b	c
PC 19-5660-01	PC 19-5661-01	12mm	15mm	70mm
PC 19-5660-02	PC 19-5661-02	15mm	15mm	75mm

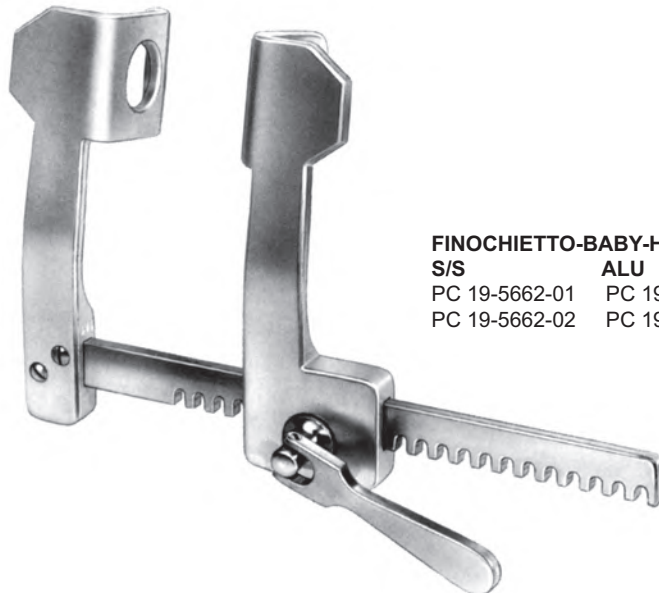

**FINOCHIETTO-BABY-HAIGHT**

S/S	ALU	a	b	c
PC 19-5662-01	PC 19-5663-01	27mm	30mm	95mm
PC 19-5662-02	PC 19-5663-02	31mm	31mm	100mm

- EN —● Rib Spreaders  
 DE —● Rippensperrer  
 ES —● Separadores costales

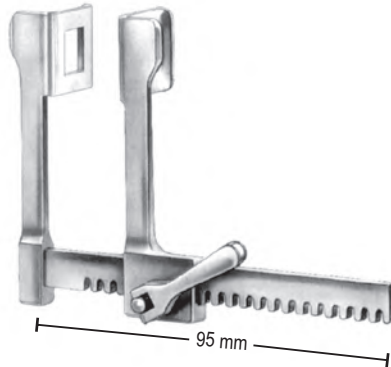
**FINOCHIETTO-BABY**

S/S	ALU	a	b	c
PC 19-5664-01	PC 19-5665-01	14mm	15mm	75mm
PC 19-5664-02	PC 19-5665-02	18mm	20mm	75mm

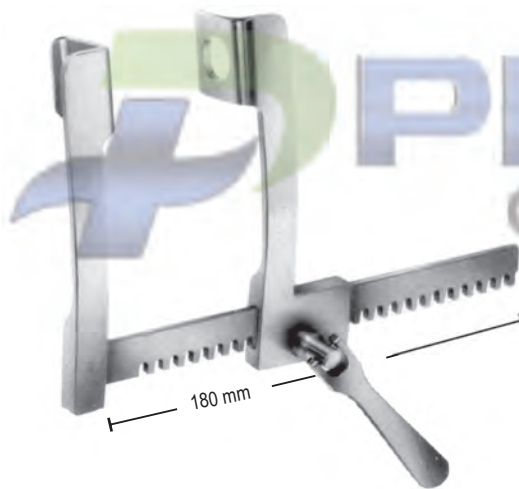

S/S	ALU	a	b	c
PC 19-5666-01	PC 19-5667-01	28mm	32mm	120mm

**FINOCHIETTO**

S/S	ALU	a	b	c
PC 19-5668-01	PC 19-5669-01	12mm	15mm	100mm
PC 19-5668-02	PC 19-5669-02	28mm	30mm	143mm
PC 19-5668-03	PC 19-5669-03	31mm	45mm	210mm
PC 19-5668-04	PC 19-5669-04	42mm	61mm	245mm
PC 19-5668-05	PC 19-5669-05	74mm	64mm	245mm

- Rib Spreaders ● EN
- Rippensperrer ● DE
- Separadores costales ● ES

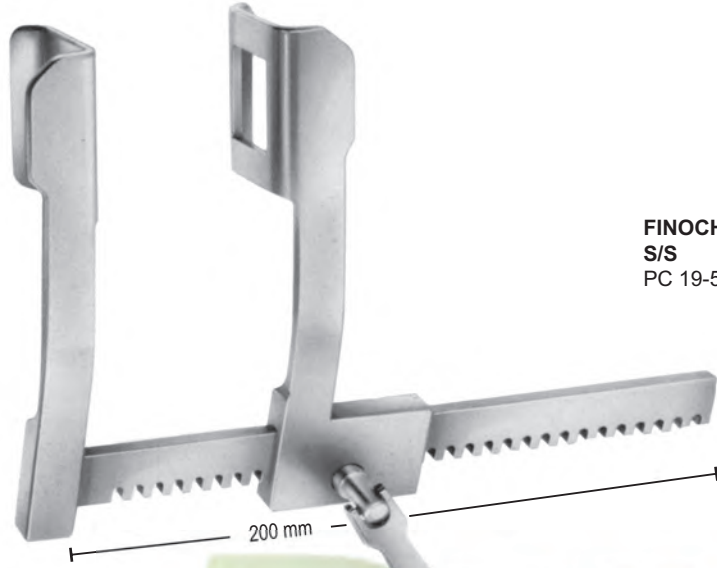

FINOCHIETTO		a	b	c
S/S	ALU			
PC 19-5670-01	PC 19-5671-01	36mm	45mm	140mm



FINOCHIETTO		a	b	c
S/S	ALU			
PC 19-5672-01	PC 19-5673-01	44mm	65mm	210mm
PC 19-5672-02	PC 19-5673-02	65mm	65mm	210mm



- EN —● Rib Spreaders  
 DE —● Rippensperrer  
 ES —● Separadores costales

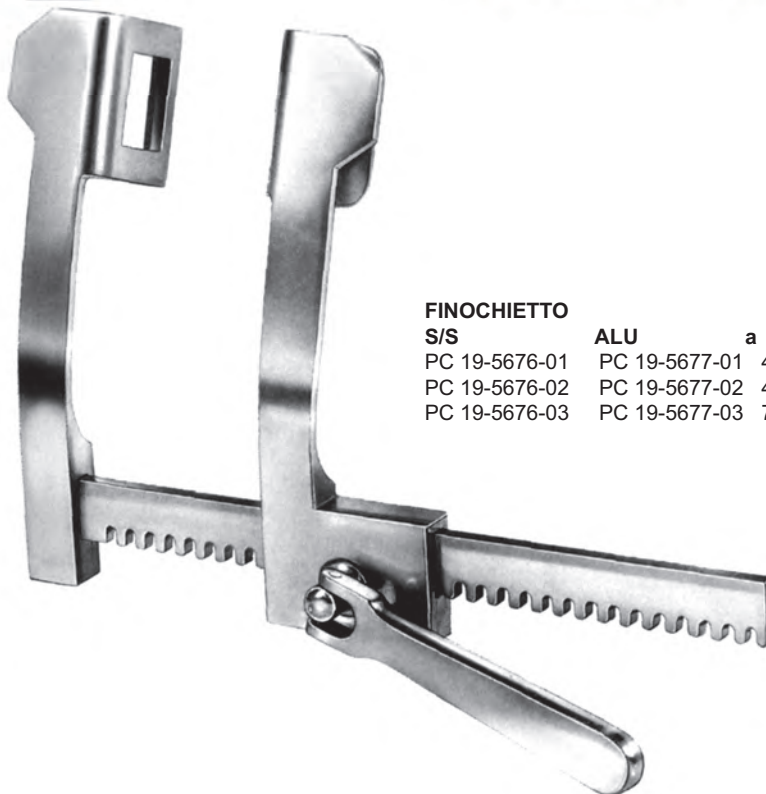

**FINOCHIETTO  
S/S**

	ALU	a	b	c
PC 19-5674-01	PC 19-5675-01	30mm	45mm	140mm
PC 19-5674-02	PC 19-5675-02	38mm	44mm	135mm
PC 19-5674-03	PC 19-5675-03	52mm	62mm	175mm
PC 19-5674-04	PC 19-5675-04	85mm	85mm	175mm

**FINOCHIETTO  
S/S**

	ALU	a	b	c
PC 19-5676-01	PC 19-5677-01	40mm	40mm	165mm
PC 19-5676-02	PC 19-5677-02	45mm	65mm	200mm
PC 19-5676-03	PC 19-5677-03	75mm	65mm	250mm

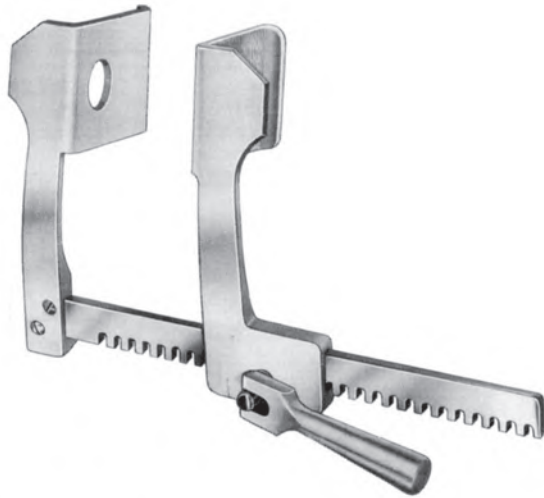
- Rib Spreaders ●— EN
- Rippensperrer ●— DE
- Senadores costales ●— ES



**FINOCHIETTO**  
for adults

S/S	ALU	a	b	c
PC 19-5678-01	PC 19-5679-01	52mm	62mm	175mm
PC 19-5678-02	PC 19-5679-02	85mm	65mm	175mm



**FINOCHIETTO**  
for adults, with suture separator

S/S	ALU	a	b	c
PC 19-5680-01	PC 19-5681-01	85mm	65mm	175mm



**FINOCHIETTO**  
for adults, with 2 blades attached to each arm

S/S	ALU	a	b	c
PC 19-5682-01	PC 19-5683-01	10mm	15mm	120mm
PC 19-5682-02	PC 19-5683-02	14mm	14mm	120mm
PC 19-5682-03	PC 19-5683-03	14mm	20mm	120mm

- EN —● Rib Spreaders  
 DE —● Rippensperrer  
 ES —● Separadores costales

**FINOCHIETTO**

3 pairs of exchangeable blades

S/S	ALU	S/S	ALU
PC 19-5684-00	PC 19-5685-00	PC 19-5686-00	PC 19-5687-00
blades		blades	
PC 19-5684-30	PC 19-5685-30	PC 19-5686-40	PC 19-5687-40
PC 19-5684-40	PC 19-5685-40	PC 19-5686-50	PC 19-5687-50
PC 19-5684-50	PC 19-5685-50	PC 19-5686-60	PC 19-5687-60
frame only 150mm		frame only 250mm	
PC 19-5684-01	PC 19-5685-01	PC 19-5686-01	PC 19-5687-.01

Interchangeable Blades ●— EN  
 Wechselven ●— DE  
 valves intercambiables ●— ES

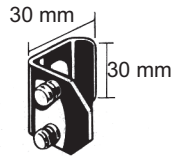

S/S      Alu  
 PC 19-5684-30   PC 19-5685-30  
 30x30mm

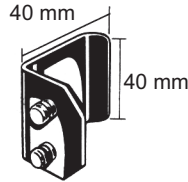

S/S      Alu  
 PC 19-5684-40   PC 19-5685-40  
 40x40mm

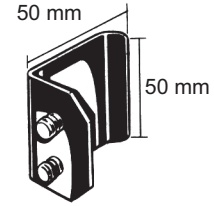

S/S      Alu  
 PC 19-5684-50   PC 19-5685-50  
 50x50mm

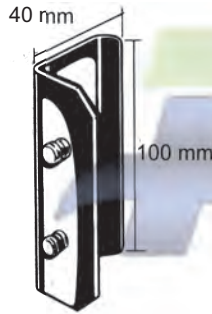

S/S      Alu  
 PC 19-5686-40   PC 19-5687-40  
 40x100mm



S/S      Alu  
 PC 19-5686-50   PC 19-5687-50  
 50x80mm

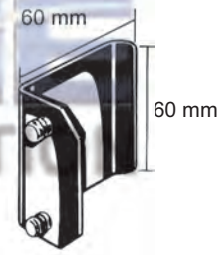

S/S      Alu  
 PC 19-5686-60   PC 19-5687-60  
 60x60mm

### Optional Exchangeable Blades

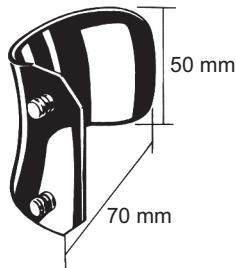

S/S      Alu  
 PC 19-5686-70   PC 19-5687-70  
 70x50mm

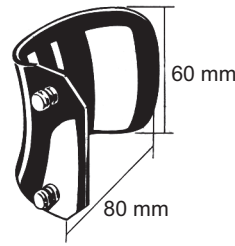

S/S      Alu  
 PC 19-5686-80   PC 19-5687-80  
 80x60mm

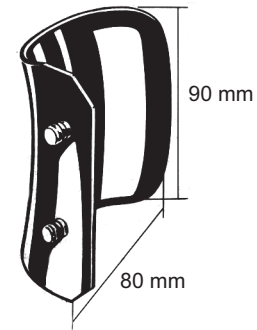

S/S      Alu  
 PC 19-5686-90   PC 19-5687-90  
 80x90mm

- EN —● Rib Spreaders
- DE —● Rippensperrer
- ES —● Separadores costales

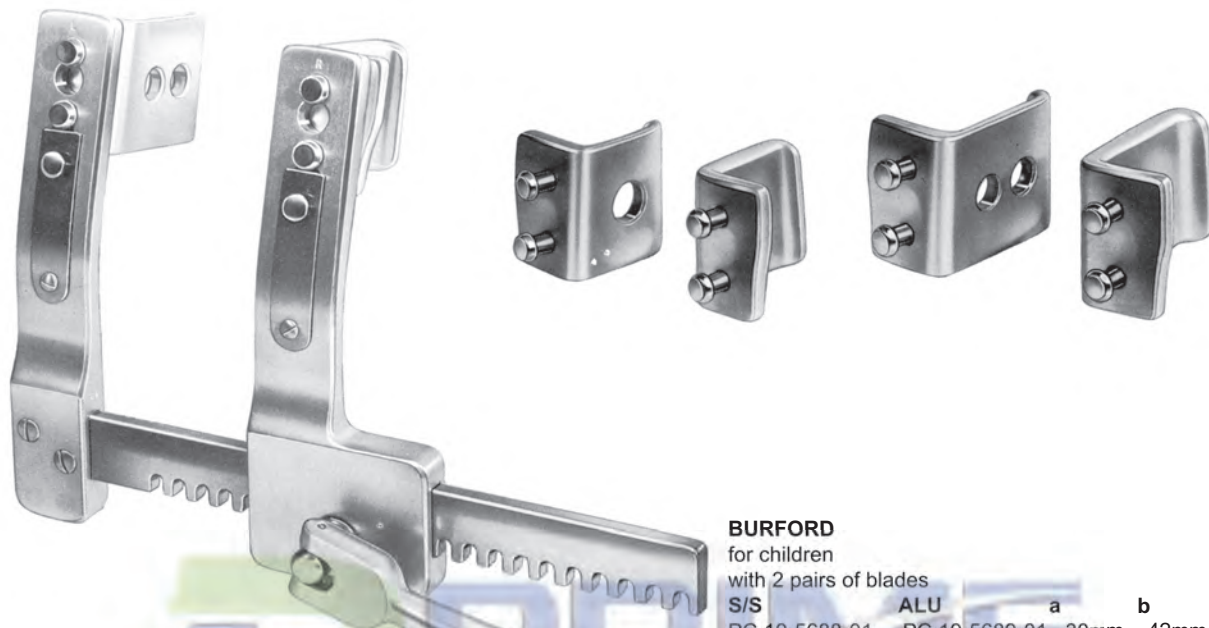

**BURFORD**  
for children  
with 2 pairs of blades

S/S	ALU	a	b	c
PC 19-5688-01	PC 19-5689-01	30mm	42mm	130mm
		41mm	42mm	
PC 19-5688-02	PC 19-5689-02	34mm	42mm	135mm
		48mm	42mm	



**BURFORD**  
for adults  
with 2 pairs of blades

S/S	ALU	a	b	c
PC 19-5690-01	PC 19-5691-01	47mm	62mm	200mm
		65mm	62mm	
PC 19-5690-02	PC 19-5691-02	47mm	62mm	260mm
		65mm	62mm	
PC 19-5690-03	PC 19-5691-03	47mm	62mm	300mm
		65mm	62mm	



- Rib Spreaders ● EN
- Rippensperrer ● DE
- Separadores costales ● ES



S/S	ALU	a	b	c
PC 19-5692-01	PC 19-5693-01	12mm	20mm	155mm
PC 19-5692-02	PC 19-5693-02	20mm	20mm	155mm
PC 19-5692-03	PC 19-5693-03	40mm	20mm	155mm
PC 19-5692-04	PC 19-5693-04	17mm	22mm	160mm

**MORSE-FAVALORO**  
4 movable blades for children

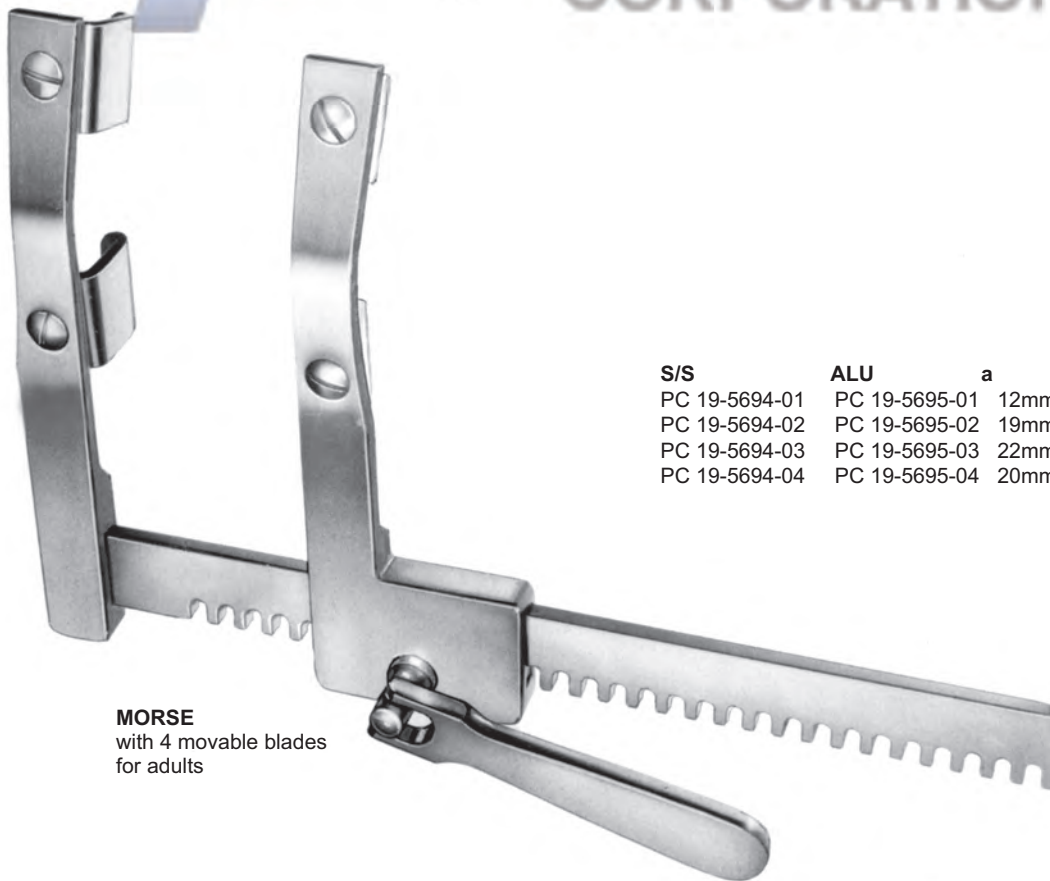

S/S	ALU	a	b	c
PC 19-5694-01	PC 19-5695-01	12mm	20mm	200mm
PC 19-5694-02	PC 19-5695-02	19mm	19mm	200mm
PC 19-5694-03	PC 19-5695-03	22mm	27mm	200mm
PC 19-5694-04	PC 19-5695-04	20mm	28mm	210mm

**MORSE**  
with 4 movable blades  
for adults

- EN —● Rib Spreaders
- DE —● Rippensperrer
- ES —● Separadores costales



**MORSE STERNAL**  
 S/S ALU a b c  
 PC 19-5696-01 PC 19-5697-01 30mm 35mm 200mm

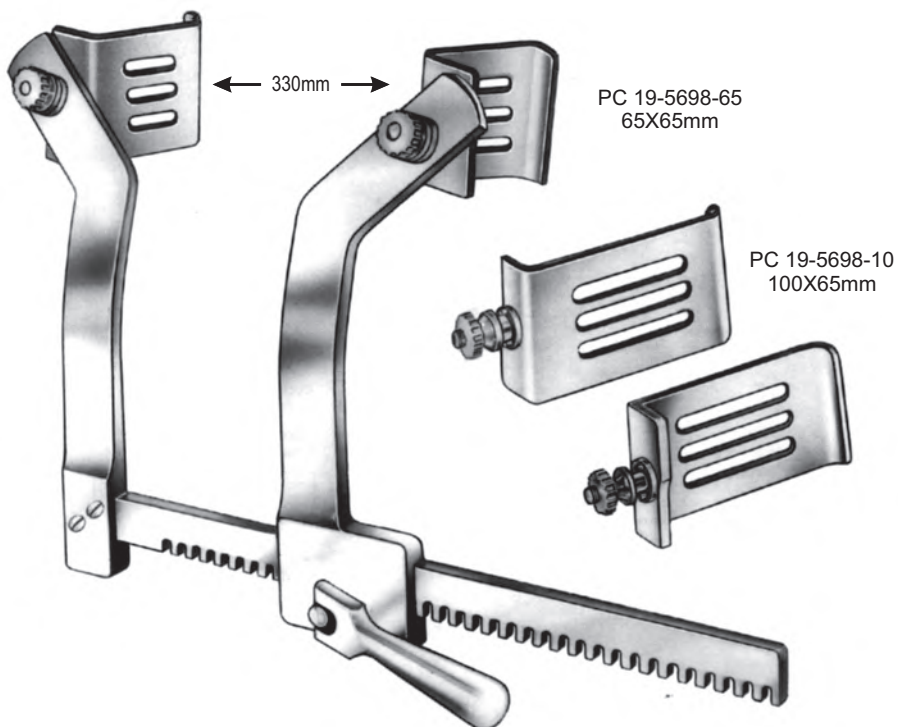

PC 19-5698-65  
65X65mm

PC 19-5698-10  
100X65mm

**BRAASTAD**  
 S/S ALU  
 PC 19-5698-01 PC 19-5699-.01  
 with 2 pairs of blades  
 PC 19-5698-65 PC 19-5699-65  
 PC 19-5698-10 PC 19-5699-10

- Rib Spreaders ●— EN
- Rippensperrer ●— DE
- Separadores costales ●— ES

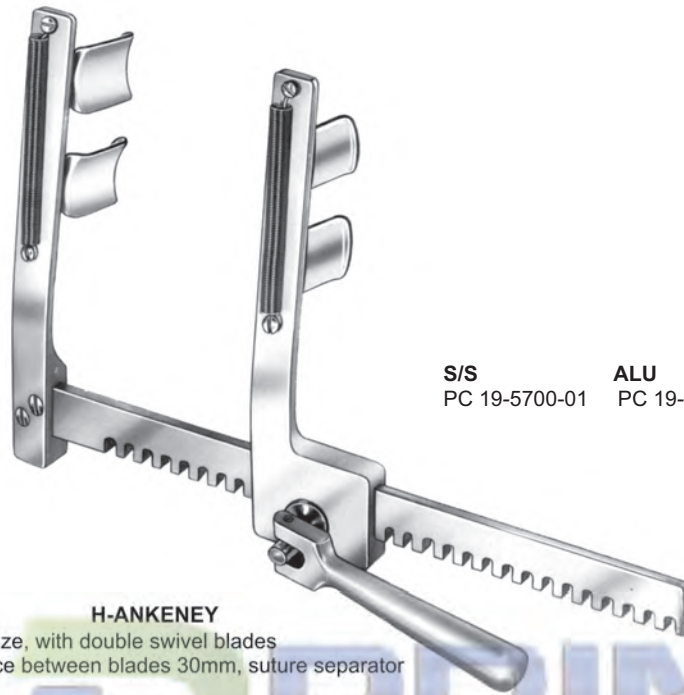

<b>S/S</b>	<b>ALU</b>	<b>a</b>	<b>b</b>	<b>c</b>
PC 19-5700-01	PC 19-5700-11	20mm	20mm	160mm

**H-ANKENEY**  
child size, with double swivel blades  
distance between blades 30mm, suture separator

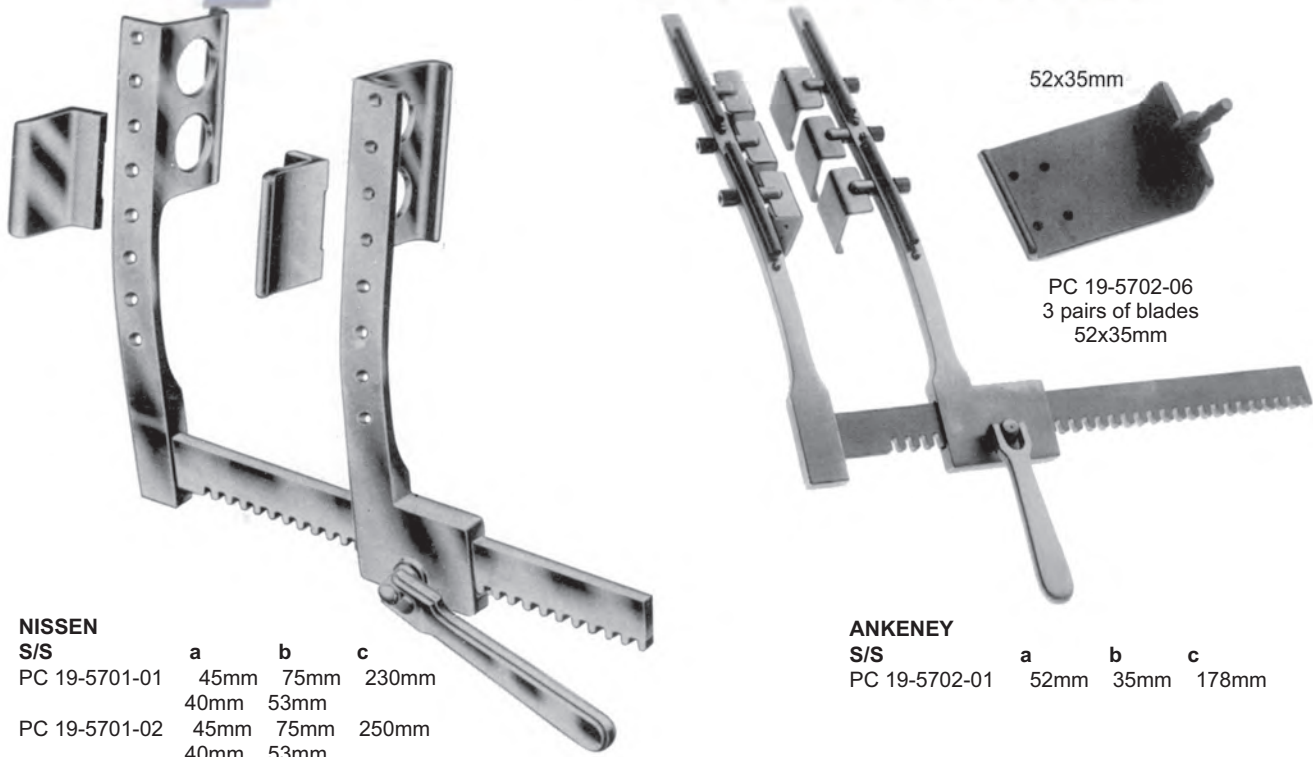

<b>NISSEN</b>			
<b>S/S</b>	<b>a</b>	<b>b</b>	<b>c</b>
PC 19-5701-01	45mm	75mm	230mm
	40mm	53mm	
PC 19-5701-02	45mm	75mm	250mm
	40mm	53mm	

<b>ANKENEY</b>			
<b>S/S</b>	<b>a</b>	<b>b</b>	<b>c</b>
PC 19-5702-01	52mm	35mm	178mm

52x35mm

PC 19-5702-06  
3 pairs of blades  
52x35mm

- EN —● Rib Spreaders
- DE —● Rippensperrer
- ES —● Separadores costales



**TUFFIER**  
**S/S**  
 PC 19-5703-14    a    b    c  
                                  32mm    19mm    110mm



**TUFFIER**  
**S/S**  
 PC 19-5704-17    a    b    c  
                                  43mm    53mm    130mm



**TUFFIER**  
**S/S**  
 PC 19-5705-16    a    b    c  
                                  50mm    45mm    165mm



- Rib Spreaders ●— EN
- Rippensperrer ●— DE
- Separadores costales ●— ES



**HAIGHT**  
S/S  
PC 19-5706-14    a    b    c  
                         30mm 30mm 90mm

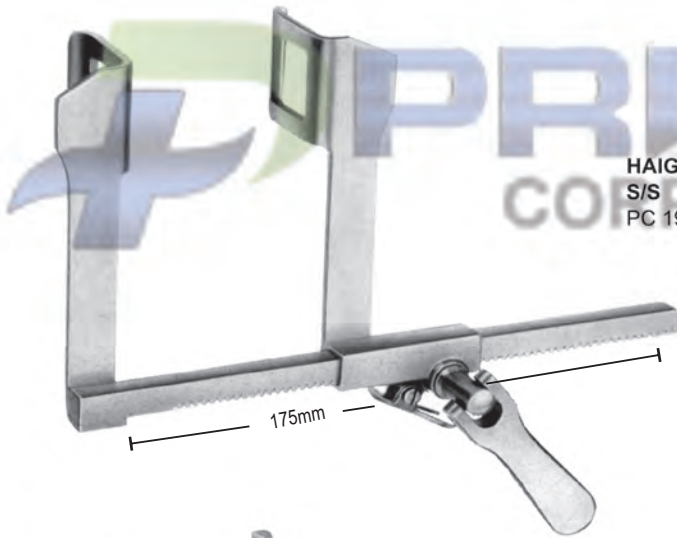

**HAIGHT**  
S/S  
PC 19-5707-15    a    b    c  
                         30mm 30mm 115mm



**HERTZLER**  
S/S  
PC 19-5708-15    a    b    c  
                         20mm 25mm 105mm



- EN —● Rib Spreaders
- DE —● Rippensperrer
- ES —● Separadores costales



**CHEVALIER**  
**S/S**                    **a**            **b**            **c**  
 PC 19-5709-19    27mm    100mm    190mm

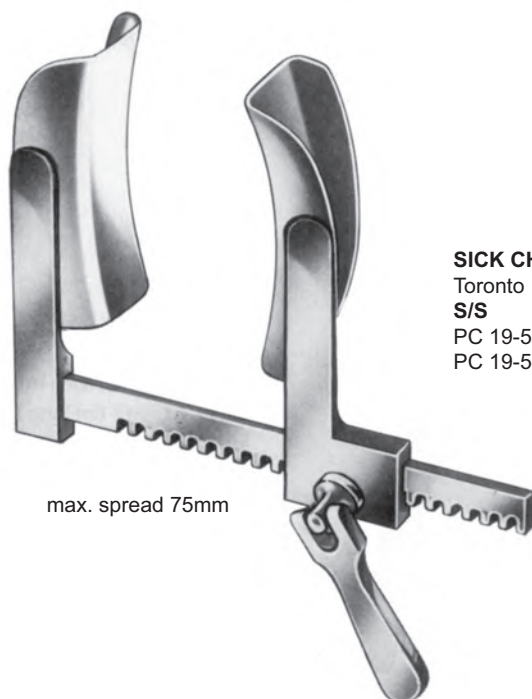

**SICK CHILDREN HOSPITAL**  
 Toronto  
**S/S**                    **a**            **b**            **c**  
 PC 19-5710-01 (child)    20mm    40mm    75mm  
 PC 19-5710-02 (adult)    20mm    60mm    75mm

max. spread 75mm

- Rib Spreaders ● EN
- Rippensperrer ● DE
- Separadores costales ● ES

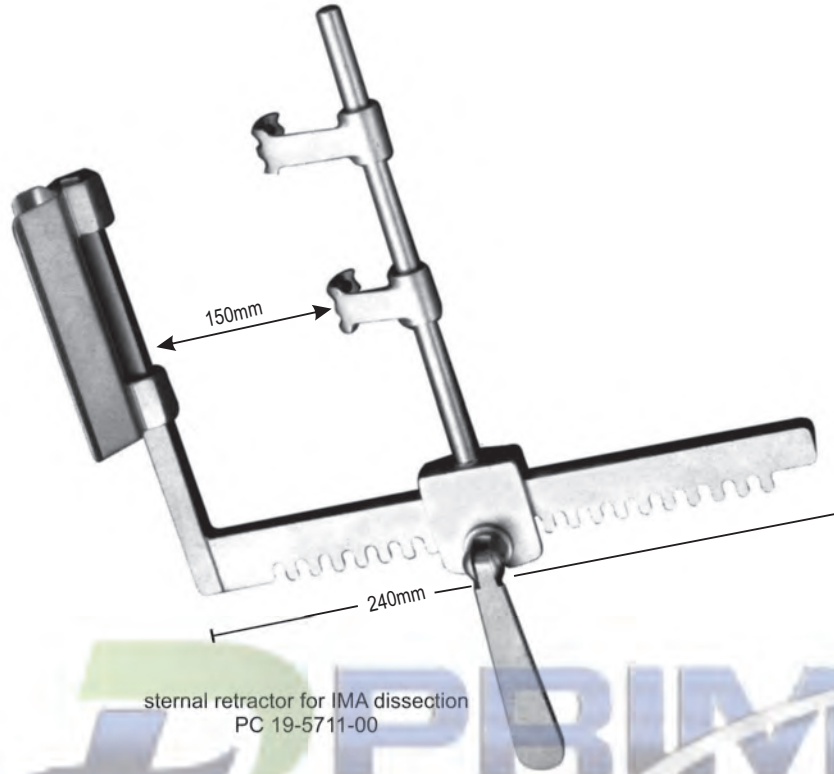

sternal retractor for IMA dissection  
PC 19-5711-00



Carpenter's thoracic retractor  
(adult)  
PC 19-5712-00 complete



- EN —● Rib Spreaders
- DE —● Rippensperrer
- ES —● Separadores costales

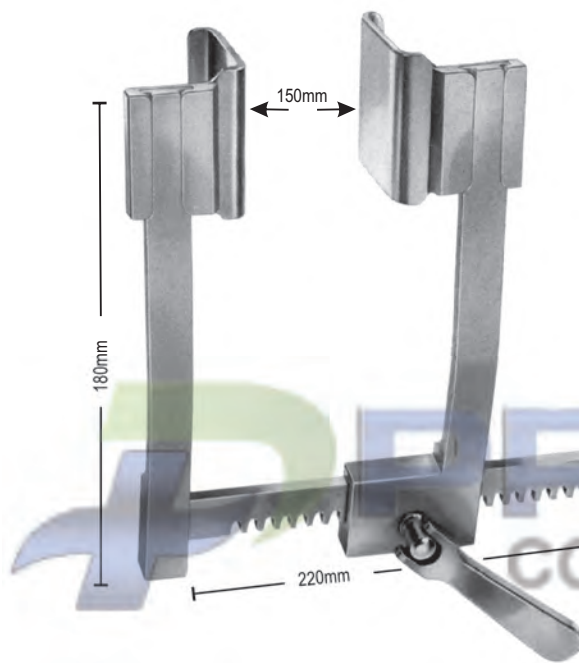

**DE BAKEY**  
 PC 19-5713-00  
 with 3 pairs of blades  
 PC 19-5713-01  
 PC 19-5713-22 spreader only



Blades  
 PC 19-5713-01  
 30 x 30 mm



Blades  
 PC 19-5713-02  
 40 x 40 mm



Blades  
 PC 19-5713-03  
 50 x 50 mm

- Rib Spreaders ● — EN
- Rippensperrer ● — DE
- Separadores costales ● — ES

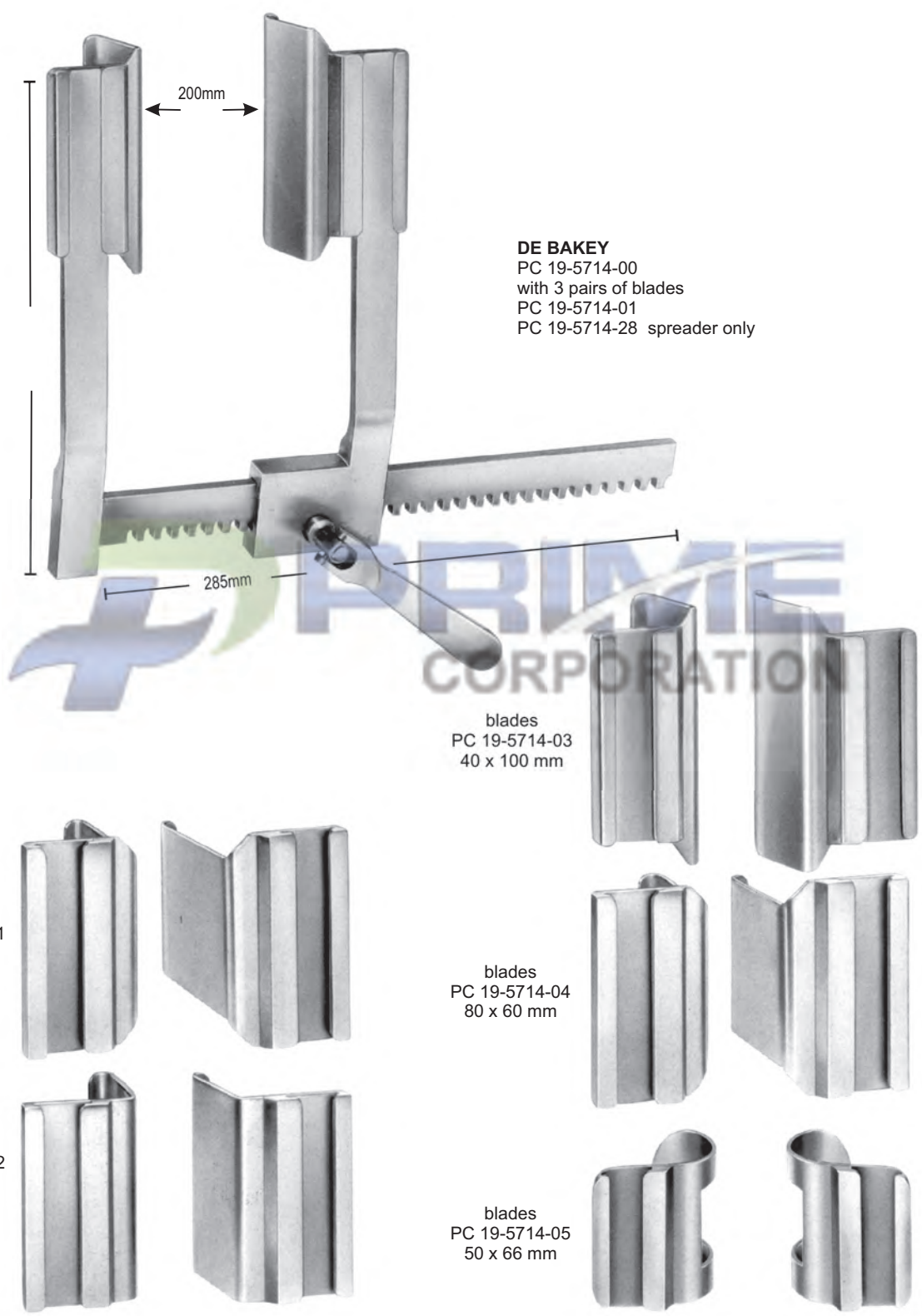

- EN —● Rib Spreaders
- DE —● Rippensperrer
- ES —● Separadores costales

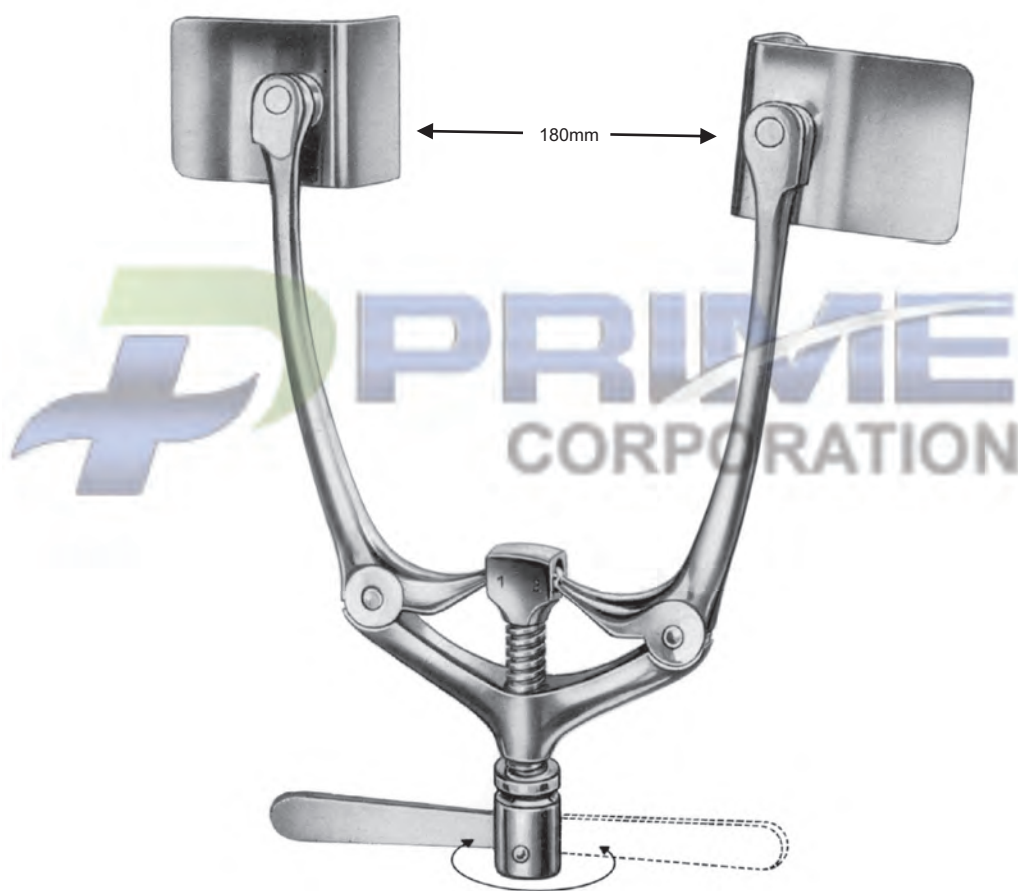

**QUERVAIN**  
PC 19-5715-00  
35 X 50 X 180 mm



Rib Spreaders ●— EN  
 Rippensperrer ●— DE  
 Separadores costales ●— ES

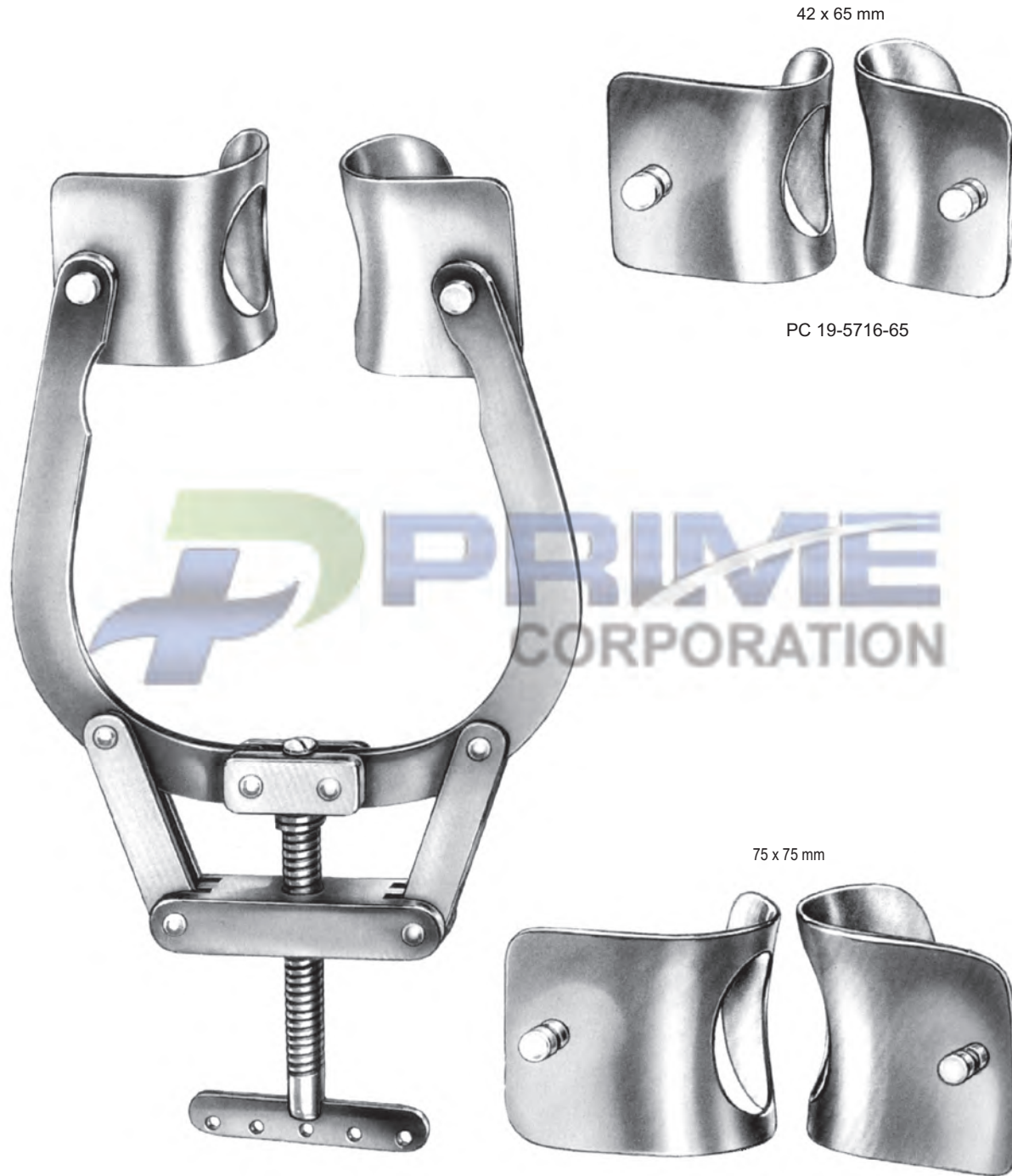

PC 19-5716-65

PC 19-5716-75

PC 19-5716-00 complete consisting of:  
 PC 19-5716-01 retractor only  
 PC 19-5716-65 1 pair blades 42x65mm  
 PC 19-5716-75 1 pair blades 75x75mm

- EN —● Rib Contractors, Lung Spatulas  
 DE —● Rippenkontraktoren, Lungenspatel  
 ES —● Aproximadores para costillas, Espátula pulmonar

**Lemmon**

PC 19-5744-18 18 cm/7"  
 PC 19-5744-14 14 cm/5½ "

**CRAFOORD**

PC 19-5744-28  
 28.0cm

- Rib Contractors, Lung Spatulas ●— EN
- Rippenkontraktoren, Lungenspatel ●— DE
- Aproximadores para costillas, Espátula pulmonar ●— ES



**Sellors**  
PC 19-5745-19  
19 cm/7½"

**Bailey-Baby**  
PC 19-5746-14  
14 cm/5½"

- EN —● Rib Contractors, Lung Spatulas
- DE —● Rippenkontraktoren, Lungenspatel
- ES —● Aproximadores para costillas, Espátula pulmonar

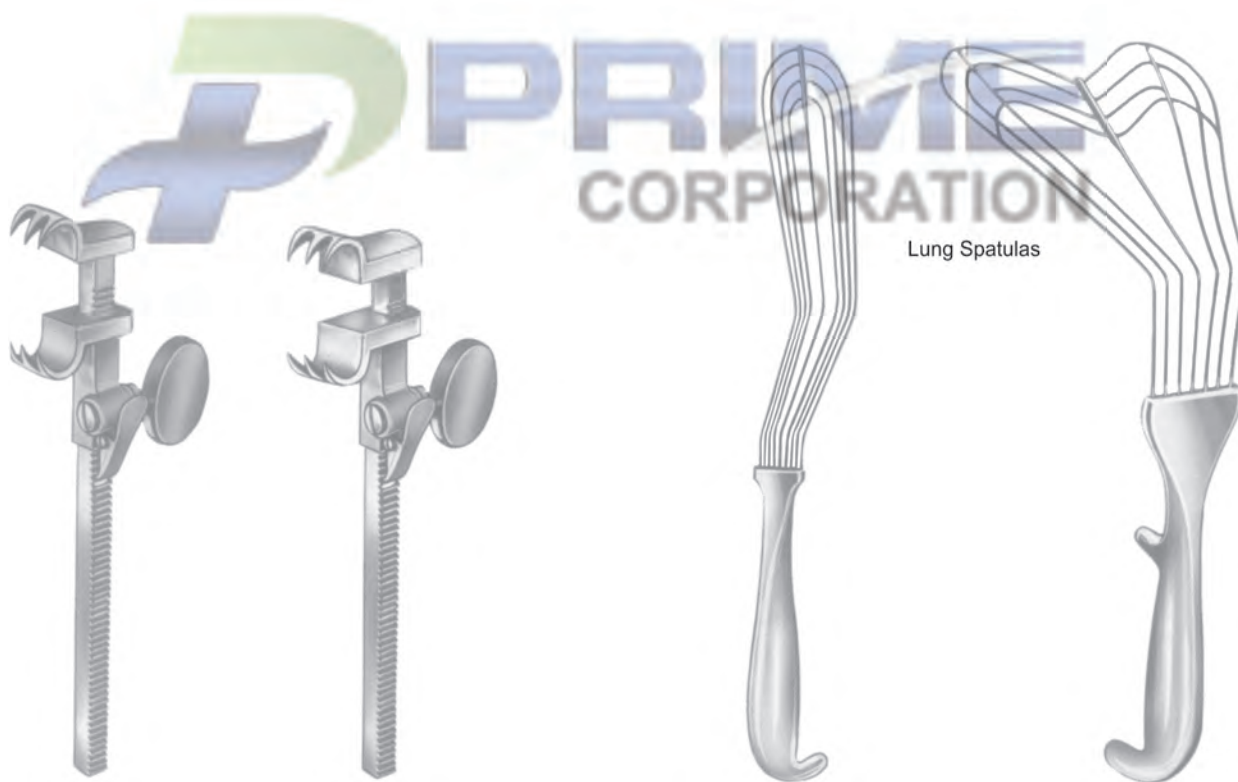

**Bailey**  
 PC 19-5747-16 16 cm/6 1/4"    PC 19-5748-16 16 cm/6 1/4"  
 PC 19-5747-20 20 cm/8"        PC 19-5748-20 20 cm/8"

**Allison**  
 PC 19-5749-25 25.5 cm/10"  
 PC 19-5749-30 30.0 cm/12"  
 PC 19-5749-32 32.0 cm/13"

PC 19-5750-30  
 30 cm/12"

Multi purpose Vascular Clamps ●— EN  
 Mehrzweck-Gefäßklemmen ●— DE  
 Pinzas vasculares de usos múltiples ●— ES

ATRAUMA

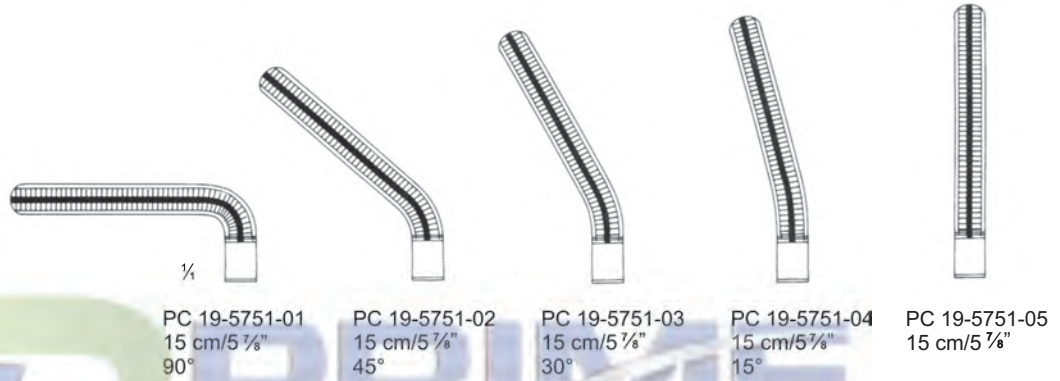

DARDIK

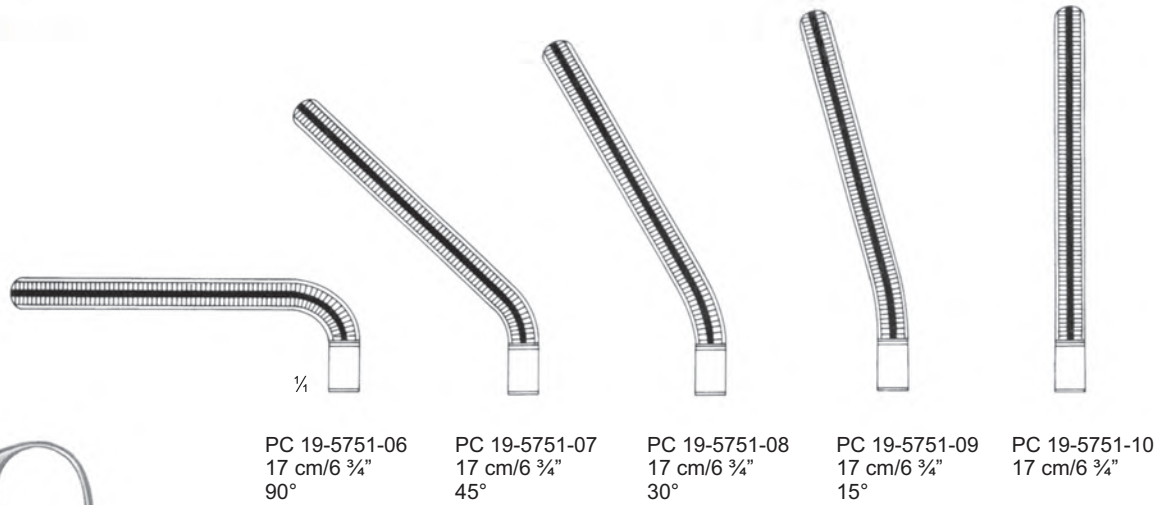



- EN —● Peripheral Vascular Clamps
- DE —● Peripheral-Gefäßklemmen
- ES —● Pinzas para vasos periféricos

ATRAUMA



DALE  
PC 19-5752-18  
18 cm/7 1/8"



1/4



DALE



PC 19-5753-17  
17.5 cm/6 7/8"



PC 19-5753-18  
18 cm/7 1/8"

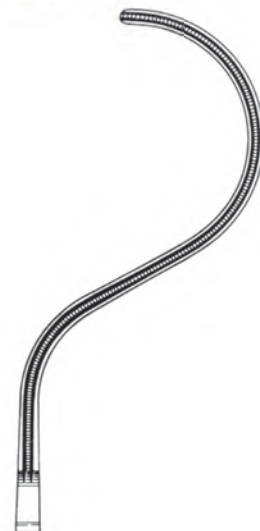

PC 19-5753-19  
19 cm/7 1/2"

- Profunda Clamps ●— EN
- Profundaklemmen ●— DE
- Pinzas para la profunda ●— ES

ATRAUMA

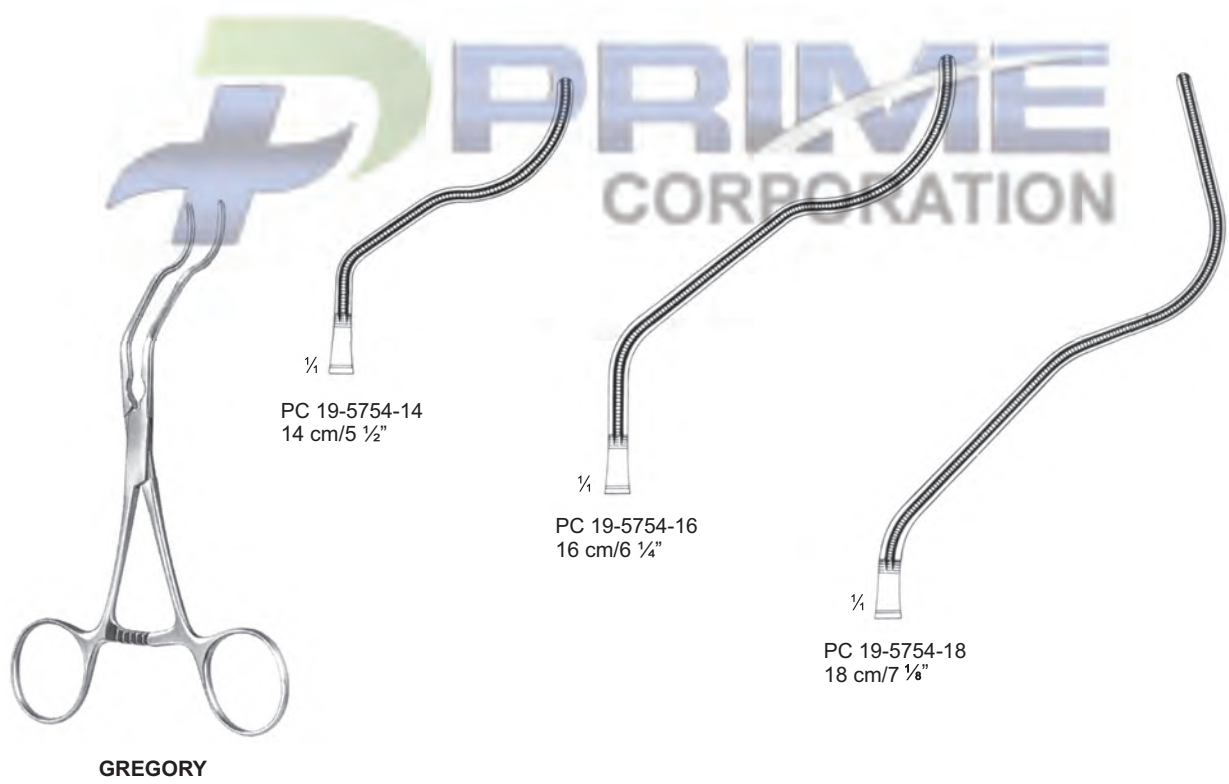

- EN —● Carotid Shunt Clamps  
 DE —● Carotis-Shuntklemmen  
 ES —● Pinzas para shunt carótido

**ATRAUMA**

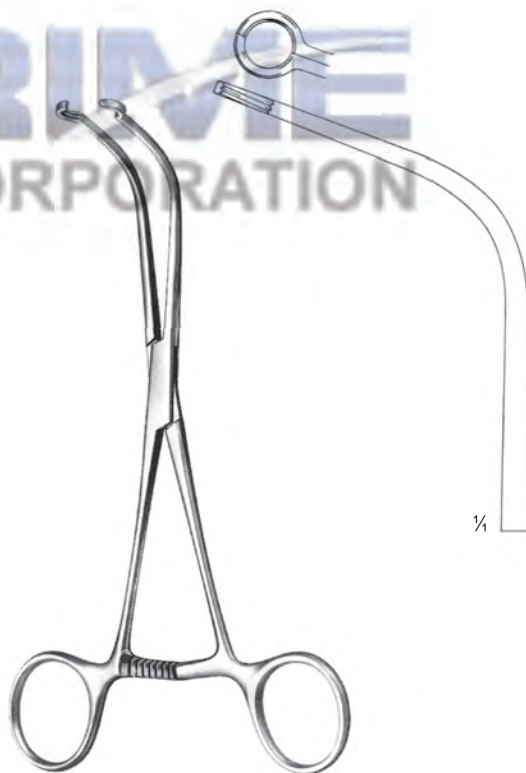

**JAVID**  
 PC 19-5755-18  
 18 cm/6 7/8"



**JAVID**  
 PC 19-5756-19  
 19 cm/7 1/4"

Peripheral Vascular Clamps ● EN  
 Peripheral-Gefäßklemmen ● DE  
 Pinzas para vasos periféricos ● ES

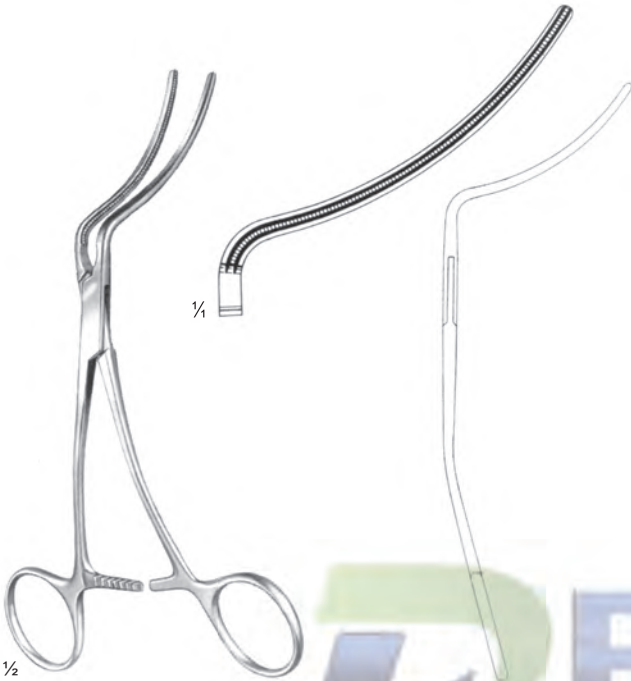
ATRAUMA



**Dardik**  
 PC 19-5757-16  
 16 cm/6 1/4"



**Dardik**  
 PC 19-5758-17  
 17 cm/6 3/4"

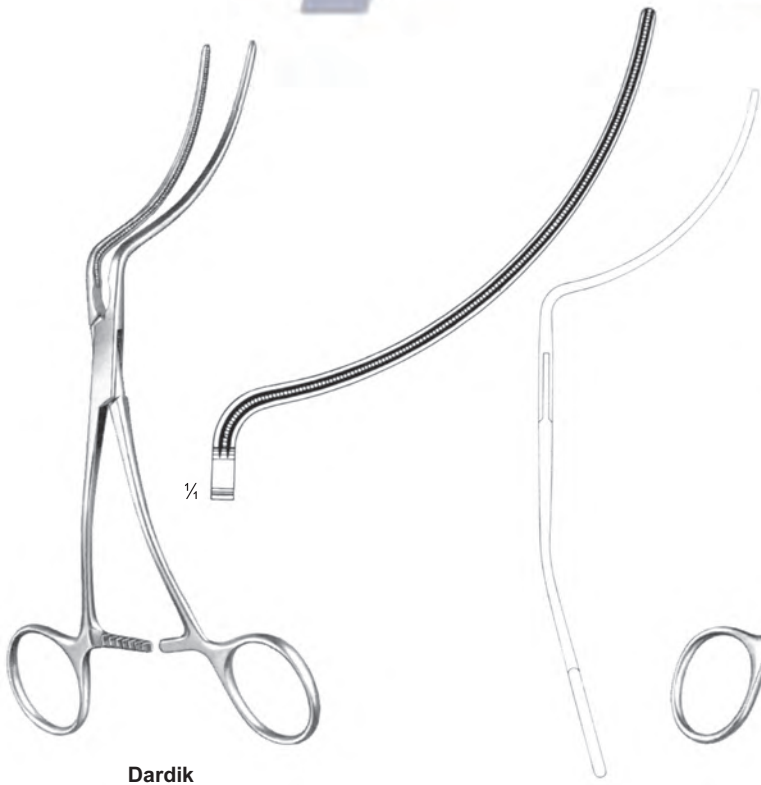

**Dardik**  
 PC 19-5759-18  
 18 cm/7 1/8"

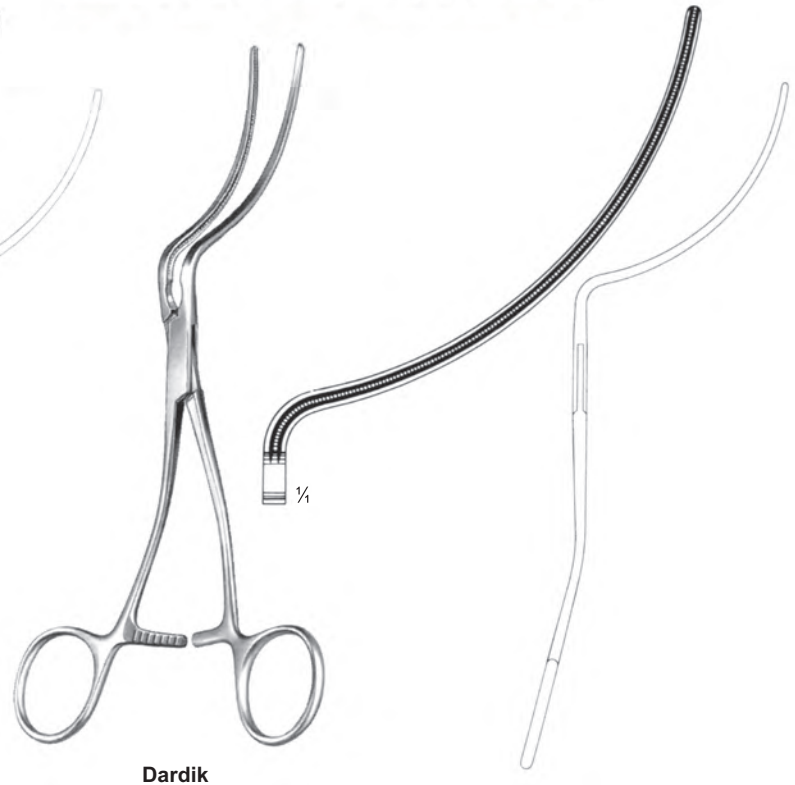

**Dardik**  
 PC 19-5760-19  
 19.5 cm/7 3/4"

- EN —● Peripheral Vascular Clamps  
 DE —● Peripheral-Gefäßklemmen  
 ES —● Pinzas para vasos periféricos

**ATRAUMA**

**HUSFELDT**  
 PC 19-5761-17  
 17.5 cm/6 7/8"

**HUSFELDT**  
 PC 19-5762-18  
 18 cm/7 1/8"

**HUSFELDT**  
 PC 19-5763-17  
 17 cm/6 3/4"



- Vascular Measuring Device ●— EN
- Gefäß-Messzirkel ●— DE
- Compas Para medir Vasos ●— ES



PC 19-5764-17  
17 cm/6 3/4"  
Vascular Measuring Device

- EN —● Catheter Clamps
- DE —● Katheterklemmen
- ES —● Pinzas para catéteres

**ATRAUMA**

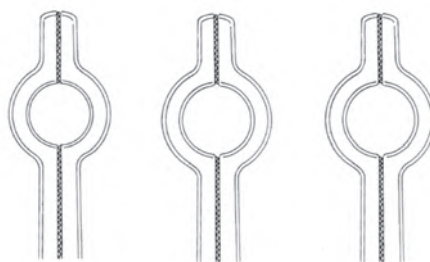

PC 19-5765-01 17 cm/6 3/4" 20 Charr.  
 PC 19-5765-02 17 cm/6 3/4" 24 Charr.  
 PC 19-5765-03 17 cm/6 3/4" 26 Charr.

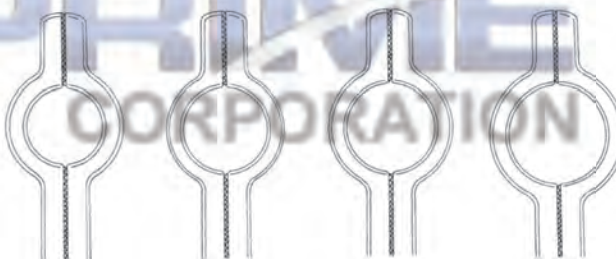

PC 19-5765-04 20 cm/7 7/8" 28 Charr.  
 PC 19-5765-05 20 cm/7 7/8" 30 Charr.  
 PC 19-5765-06 20 cm/7 7/8" 32 Charr.  
 PC 19-5765-07 20 cm/7 7/8" 36 Charr.

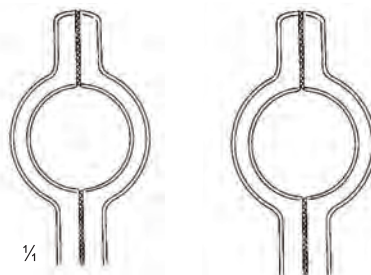

PC 19-5765-08 20 cm/7 7/8" 38 Charr.  
 PC 19-5765-09 20 cm/7 7/8" 40 Charr.



**COOLEY**

- Coarctation Clamps ●— EN
- Coarctationsklemmen ●— DE
- Pinzas para coarctación ●— ES

ATRAUMA



PC 19-5766-21  
21 cm/8 1/4"

PC 19-5766-22  
22.5 cm/8 3/4"

PC 19-5767-20  
20.5 cm/8 1/8"

PC 19-5767-22  
22 cm/8 3/4"

POTTS

POTTS



PC 19-5768-20  
20.5 cm/8 1/8"

PC 19-5768-22  
22 cm/8 3/4"

POTTS

- EN —● Anastomosis Clamps, Ligature Forceps
- DE —● Anastomosenklemmen, Ligaturklemmen
- ES —● Pinzas para anastomosis, Pinzas para ligaduras

**ATRAUMA**



**POTTS-GLOVER**  
PC 19-5769-21  
21.5 cm/8 1/2"



**POTTS**  
PC 19-5770-22  
22 cm/8 3/4"



**DEBAKEY**  
Dissecting and Ligature Forceps

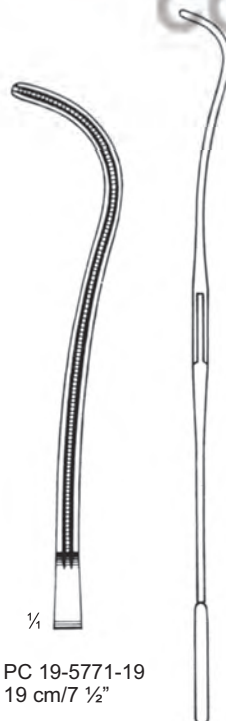

PC 19-5771-19  
19 cm/7 1/2"



PC 19-5771-24  
24 cm/9 1/2"



Peripheral Vascular Clamps ●— EN  
 Peripheral-Gefäßklemmen ●— DE  
 Pinzas para vasos periféricos ●— ES

ATRAUMA



**DEBAKEY**  
 PC 19-5772-16  
 16 cm/6 1/4"

**DEBAKEY**  
 PC 19-5773-19  
 19 cm/7 1/2"

**DEBAKEY**  
 PC 19-5774-20  
 20 cm/8"

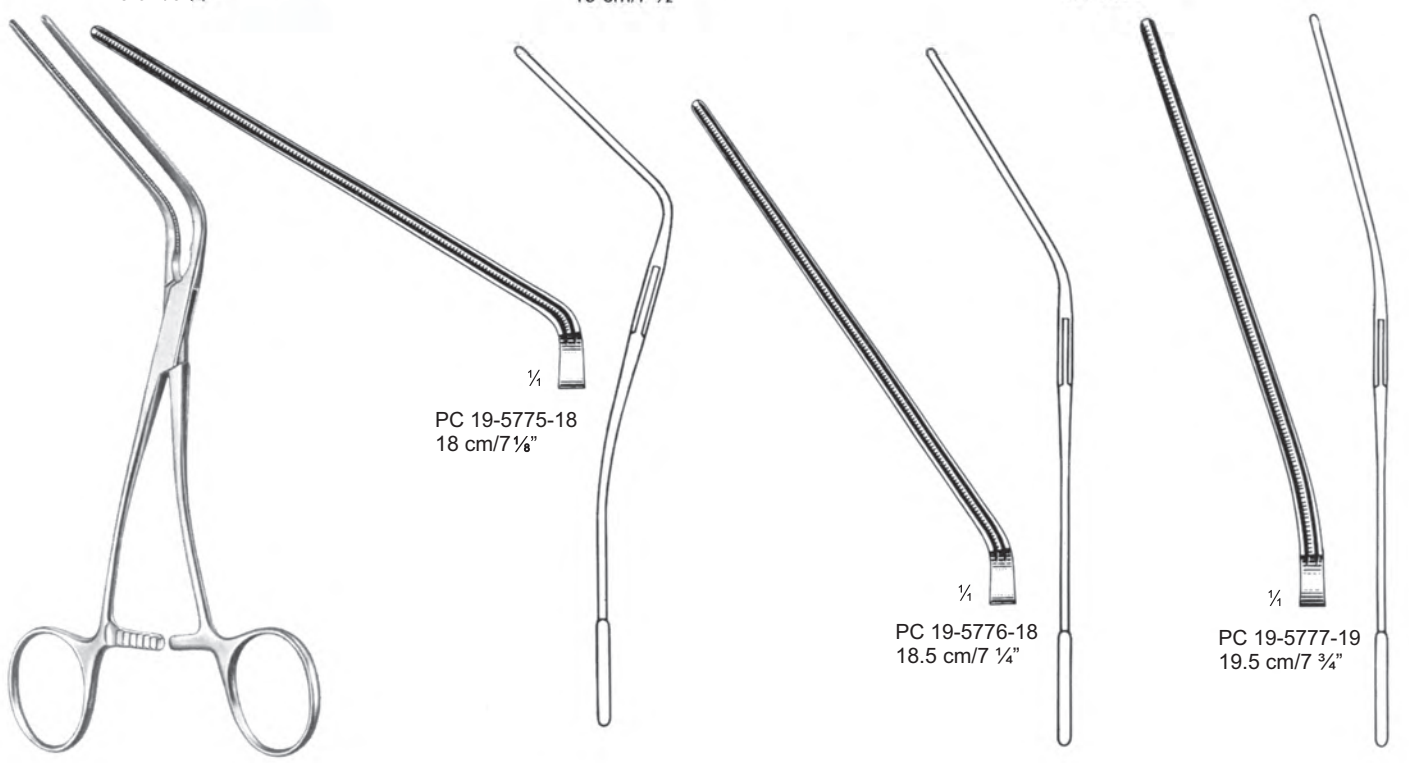

PC 19-5775-18  
 18 cm/7 1/8"

PC 19-5776-18  
 18.5 cm/7 1/4"

PC 19-5777-19  
 19.5 cm/7 3/4"

**LELAND-JONES**



- EN —● Multipurpose Vascular Clamps
- DE —● Mehrzweck-Gefäßklemmen
- ES —● Pinzas vasculares de usos múltiples

**ATRAUMA**

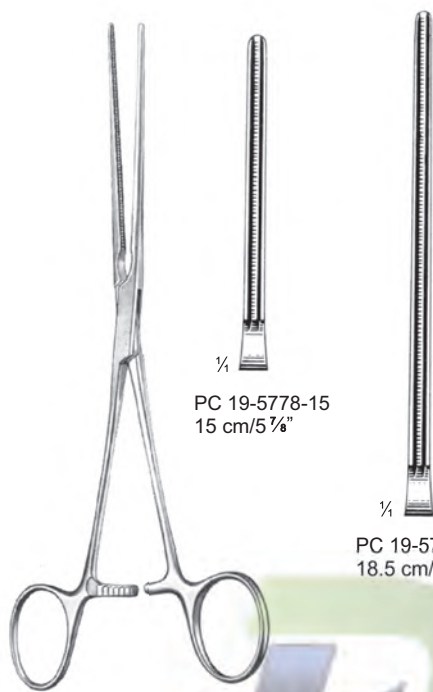

PC 19-5778-15  
15 cm/5 7/8"

PC 19-5778-18  
18.5 cm/7 1/4"

BAINBRIDGE



PC 19-5779-15  
15 cm/5 7/8"

PC 19-5779-18  
18.5 cm/7 1/4"

BAINBRIDGE

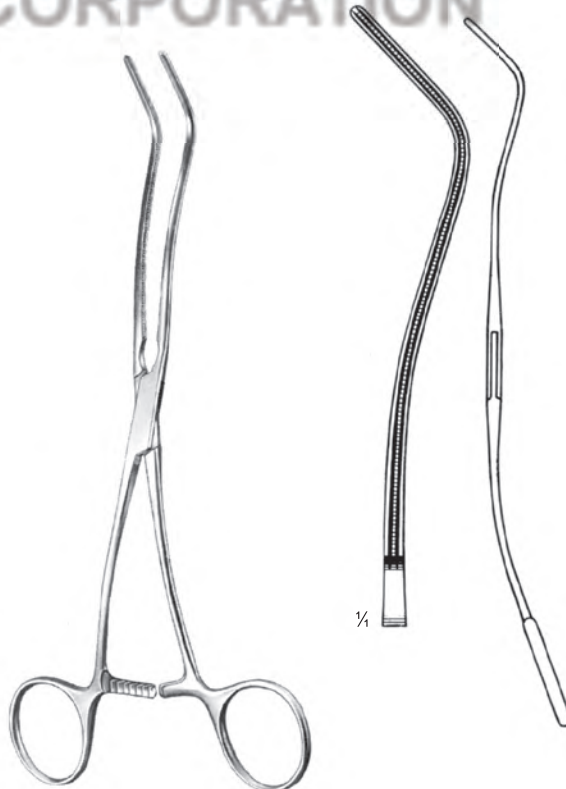

DEBAKEY  
PC 19-5780-20  
20 cm/7 7/8"

- Aortic Aneurysm Clamps ● EN
- Aorta-Aneurysmaklemmen ● DE
- Pinzas para aneurisma de aórtica ● ES

ATRAUMA



DEBAKEY

- EN —● Aortic Aneurysm Clamps
- DE —● Aorta-Aneurysmaklemmen
- ES —● Pinzas para aneurisma de aórtica

**ATRAUMA**

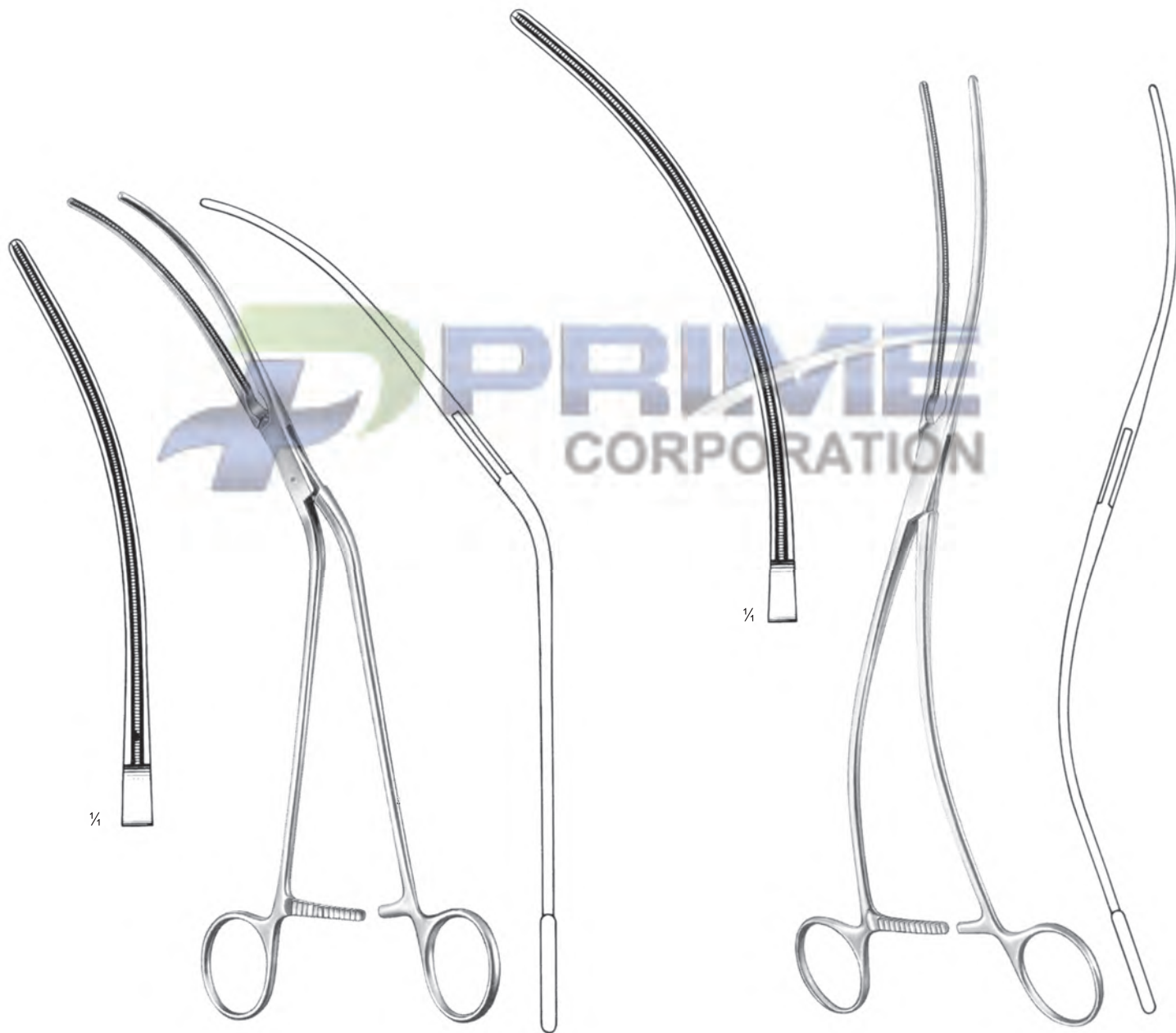

**DEBAKEY**  
PC 19-5785-28  
28 cm/11"

**DEBAKEY**  
PC 19-5786-30  
30 cm/11 3/4"

- Aortic Clamps, Ligature Forceps ●— EN
- Aortaklemmen, Ligaturklemmen ●— DE
- Pinzas aórticas, Pinzas para ligaduras ●— ES

ATRAUMA

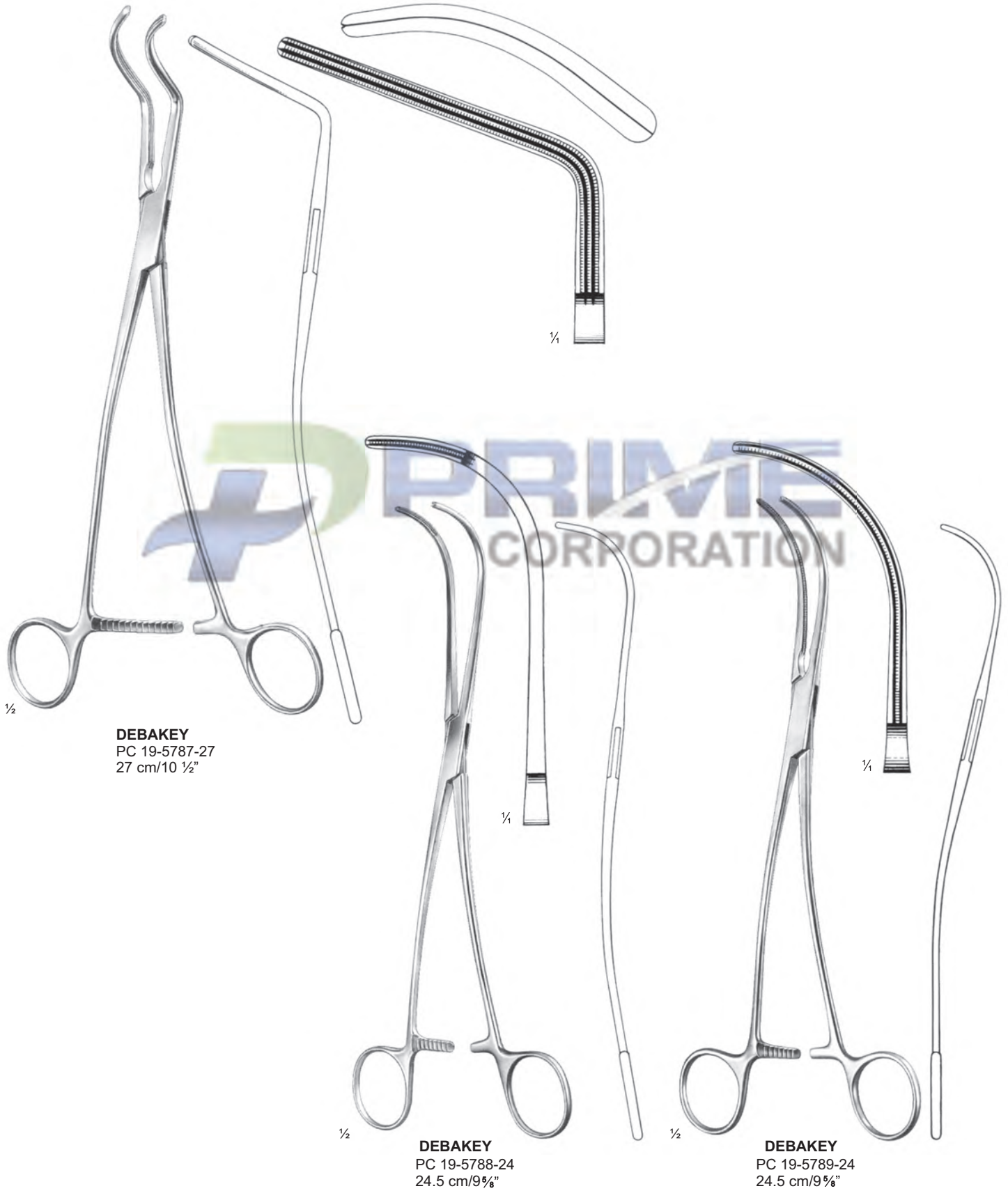

- EN —● Aortic Clamps, Ligature Forceps
- DE —● Aortaklemmen, Ligaturklemmen
- ES —● Pinzas aórticas, Pinzas para ligaduras

**ATRAUMA**



**DEBAKEY**  
PC 19-5790-27  
27 cm/10 1/2"



**DEBAKEY**  
PC 19-5791-27  
27 cm/10 1/2"



- Aortic Clamps ●— EN
- Aortaklemmen ●— DE
- Pinzas aórticas ●— ES

**ATRAUMA**

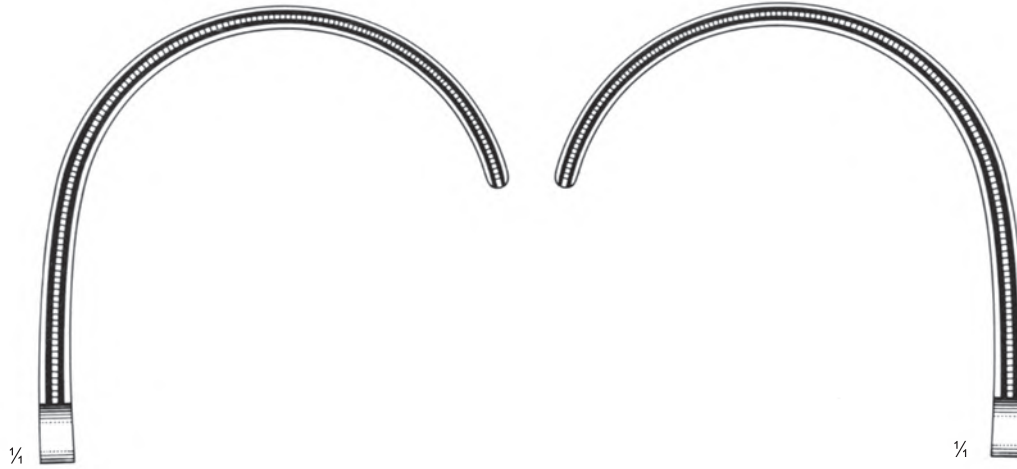

**WEBER**  
PC 19-5792-24  
24 cm/9 1/2"

**WEBER**  
PC 19-5793-24  
24 cm/9 1/2"

- EN —● Tangential Occlusion Clamps
- DE —● Tangentialklemmen
- ES —● Pinzas para oclusión tangencial

**ATRAUMA**

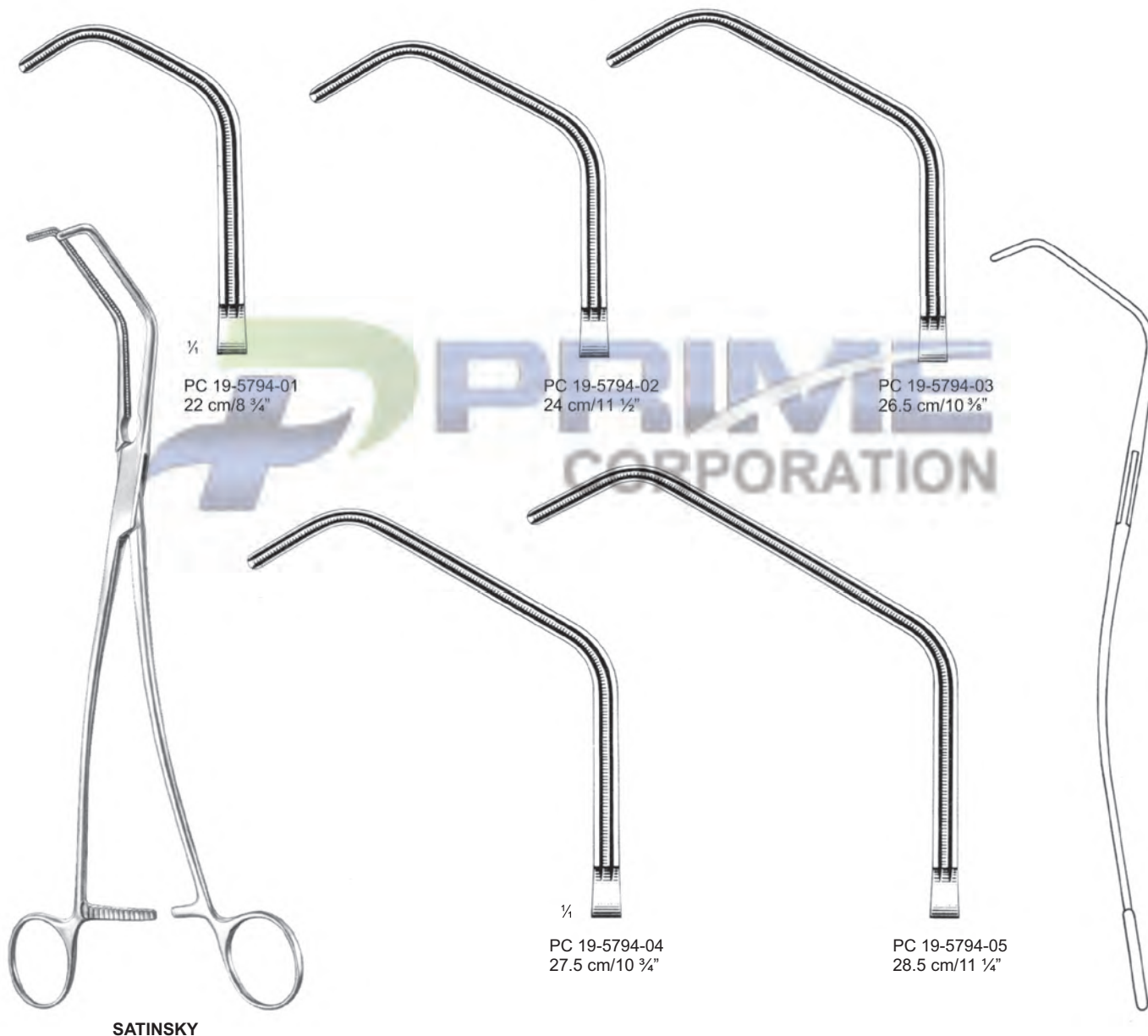

- Aortic Clamps ● EN
- Aortaklemmen ● DE
- Pinzas aórticas ● ES

**ATRAUMA**



PC 19-5795-01  
24.5 cm/9 5/8"

PC 19-5795-02  
24 cm/9 1/2"

**HARKEN**

PC 19-5795-03  
23 cm/9"

PC 19-5795-04  
23.5 cm/9 1/4"

- EN —● Tangential Occlusion Clamps  
 DE —● Tangentialklemmen  
 ES —● Pinzas para oclusión tangencial

**ATRAUMA**

- Bronchus Clamps ● EN
- Bronchusklemmen ● DE
- Pinzas bronquiales ● ES

ATRAUMA



**LEES**  
PC 19-5798-25  
25 cm/9 7/8"



- EN —● Anastomosis Clamps
- DE —● Anastomosenklemmen
- ES —● Pinzas para anastomosis

**ATRAUMA**



**LAMBERT-KAY**

PC 19-5799-01  
22.5 cm/8 3/4"

PC 19-5799-02  
22.5 cm/8 3/4"

**DEBAKEY**  
PC 19-5800-16  
16.5 cm/6 1/2"

- Aortic Clamps ●— EN
- Aortaklemmen ●— DE
- Pinzas aórticas ●— ES

ATRAUMA

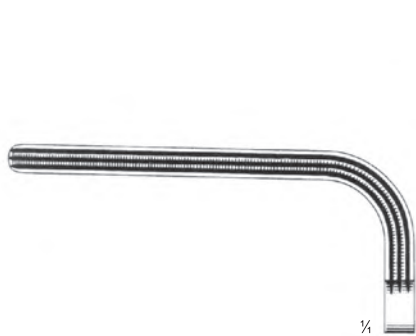

PC 19-5801-18  
18.5 cm/7 1/4"

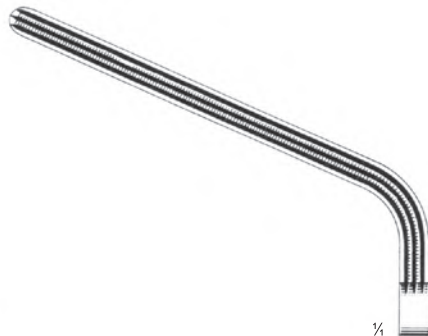

PC 19-5801-20  
20 cm/7 7/8"



MORRIS-DEBAKEY



PC 19-5801-26  
26 cm/10 1/4"

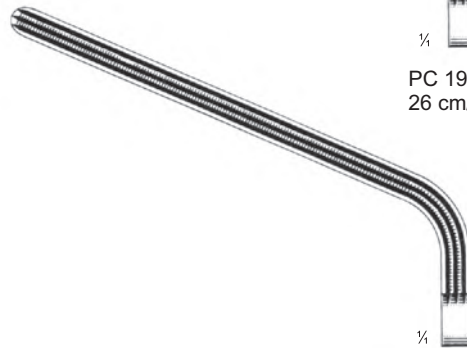

PC 19-5801-27  
27.5 cm/10 3/4"

- EN —● Anastomosis Clamps
- DE —● Anastomosenklemmen
- ES —● Pinzas para anastomosis

**ATRAUMA**



**DEBAKEY-BAHNSON**

¼  
PC 19-5802-23  
23.5 cm/9 ¼"



¼  
PC 19-5802-24  
24.5 cm/9 ⅝"

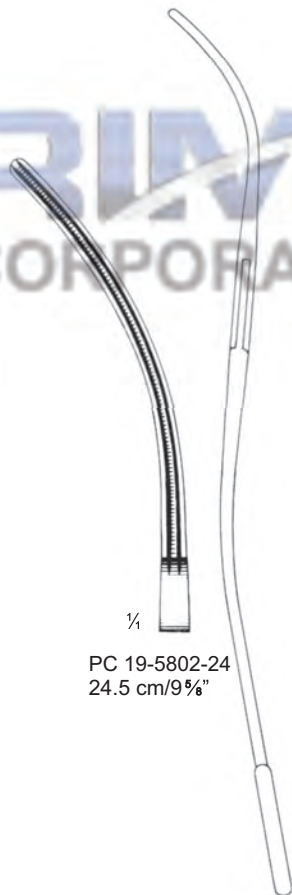

¼  
PC 19-5802-25  
25.5 cm/10"



Multi purpose Vascular Clamps ● EN  
 Mehrzweck-Gefäßklemmen ● DE  
 Pinzas vasculares de usos múltiples ● ES

**ATRAUMA**



**POTTS**



PC 19-5803-21  
21.5 cm/8 1/2"



PC 19-5803-23  
23.5 cm/9 1/4"



PC 19-5803-27  
27 cm/10 1/2"



PC 19-5803-31  
31.5 cm/12 3/8"



**POTTS**



PC 19-5804-21  
21 cm/8 1/4"



PC 19-5804-23  
23 cm/9"



PC 19-5804-26  
26 cm/10 1/4"



PC 19-5804-31  
31 cm/12 1/4"

- EN —● Multi purpose Vascular Clamps
- DE —● Mehrzweck-Gefäßklemmen
- ES —● Pinzas vasculares de usos múltiples

**ATRAUMA**

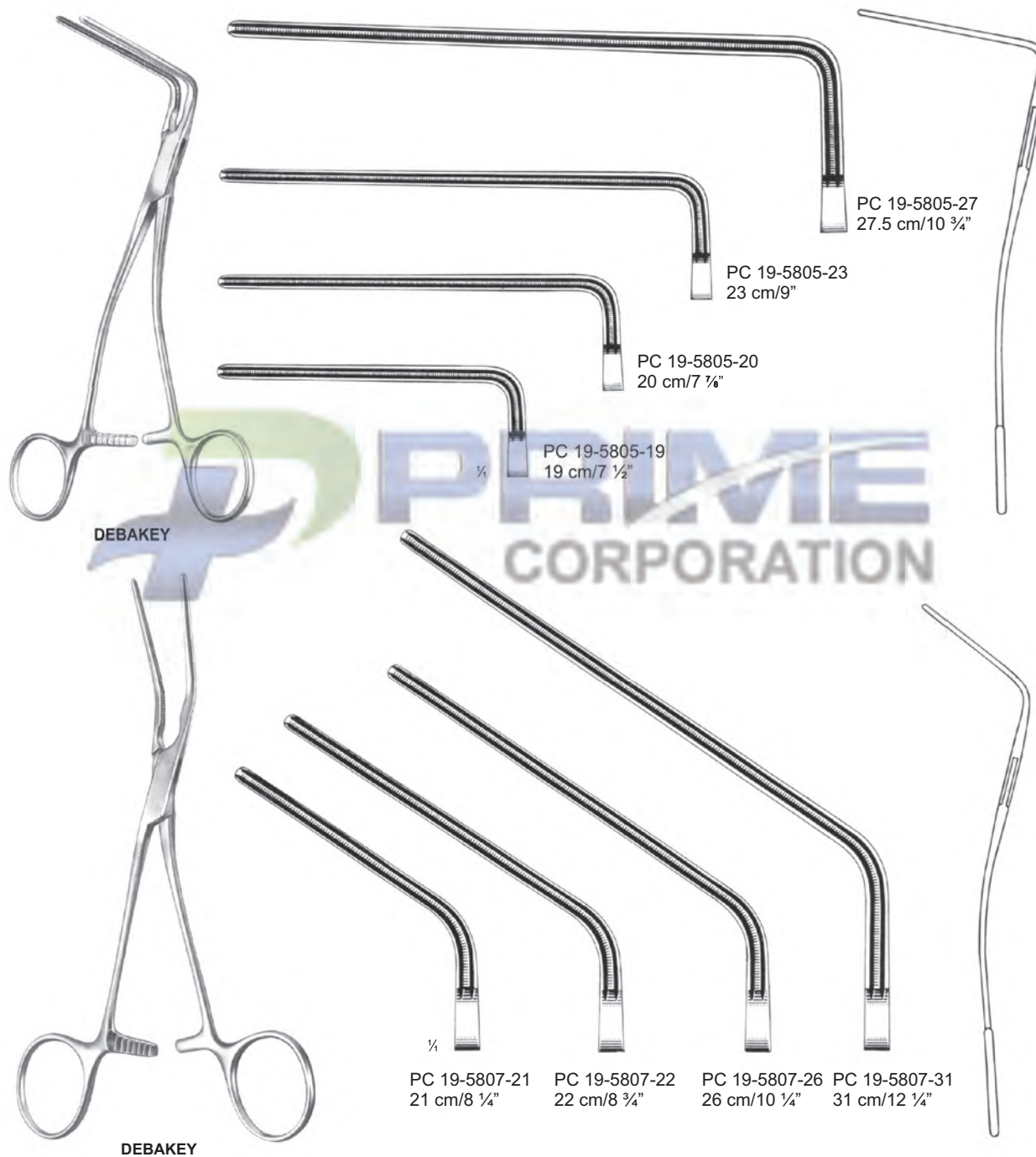



Multi purpose Vascular Clamps ● EN  
 Mehrzweck-Gefäßklemmen ● DE  
 Pinzas vasculares de usos múltiples ● ES

**ATRAUMA**



**DEBAKEY**  
PC 19-5808-17  
17 cm/6 3/4"

**DEBAKEY**  
PC 19-5809-16  
16.5 cm/6 1/2"

**DEBAKEY**  
PC 19-5810-16  
16 cm/6 1/4"



**DEBAKEY**  
PC 19-5811-14  
14.5 cm/5 3/4"



**DEBAKEY**  
PC 19-5812-16  
16.5 cm/6 1/2"

- EN — Pediatric Vascular Clamps
- DE — Kinder-Gefäßklemmen
- ES — Pinzas vasculares pediátricas

**ATRAUMA**



**DEBAKEY**  
PC 19-5813-10  
10 cm/3 7/8"

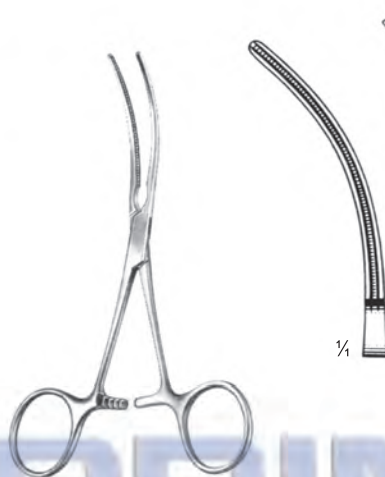

**DEBAKEY**  
PC 19-5814-12  
12.5 cm/4 7/8"

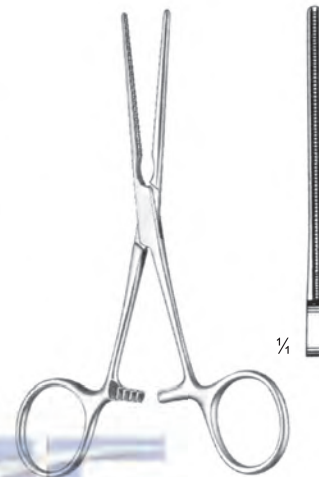

**DEBAKEY**  
PC 19-5815-13  
13 cm/5 1/8"



**DEBAKEY**  
PC 19-5816-12  
12.5 cm/4 7/8"



**DEBAKEY**  
PC 19-5817-12  
12.5 cm/4 7/8"

Multi purpose Vascular Clamps ●— EN  
 Mehrzweck-Gefäßklemmen ●— DE  
 Pinzas vasculares de usos múltiples ●— ES

ATRAUMA

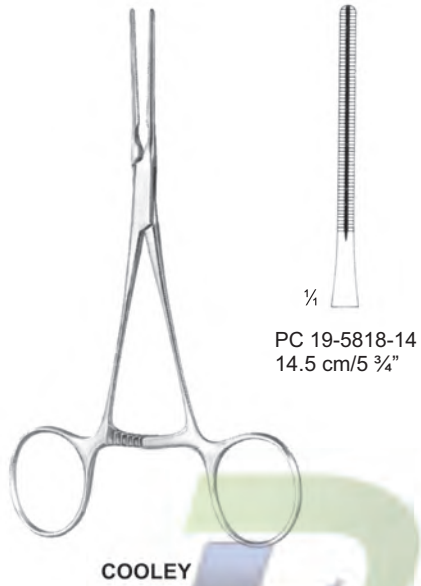

PC 19-5818-14  
14.5 cm/5 3/4"



PC 19-5819-14  
14.5 cm/5 3/4"



COOLEY  
PC 19-5820-14  
14 cm/5 1/2"



COOLEY  
PC 19-5821-14  
14 cm/5 1/2"

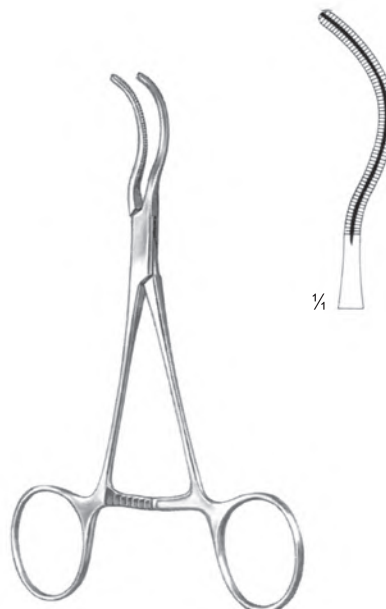

COOLEY  
PC 19-5822-14  
14.5 cm/5 3/4"

- EN —● Anastomosis Clamps
- DE —● Anastomosenklemmen
- ES —● Pinzas para anastomosis

**ATRAUMA**

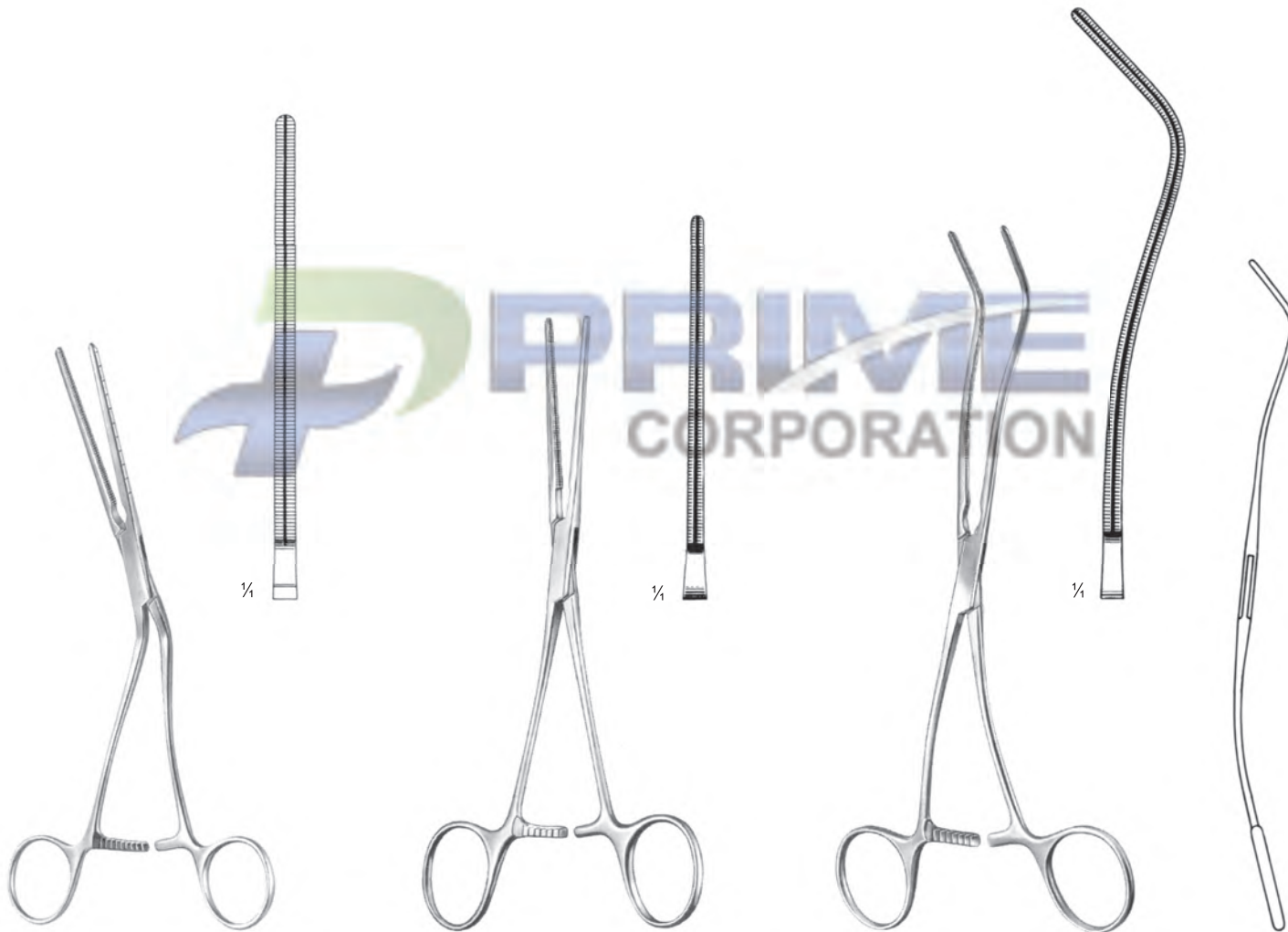

**COOLEY**  
 PC 19-5823-22 22 cm/8 ¾"  
 PC 19-5823-25 25 cm/12"  
 Liliac Clamp

**COOLEY**  
 PC 19-5824-17  
 17 cm/6 ¾"

**COOLEY**  
 PC 19-5825-20  
 20 cm/7 ¾"  
 Carotid Clamps



Anastomosis Clamps, Multi purpose Vascular Clamps — EN  
 Anastomosenklemmen, Mehrzweck-Gefäßklemmen — DE  
 Pinzas para anastomosis, Pinzas vasculares de usos múltiples — ES

ATRAUMA

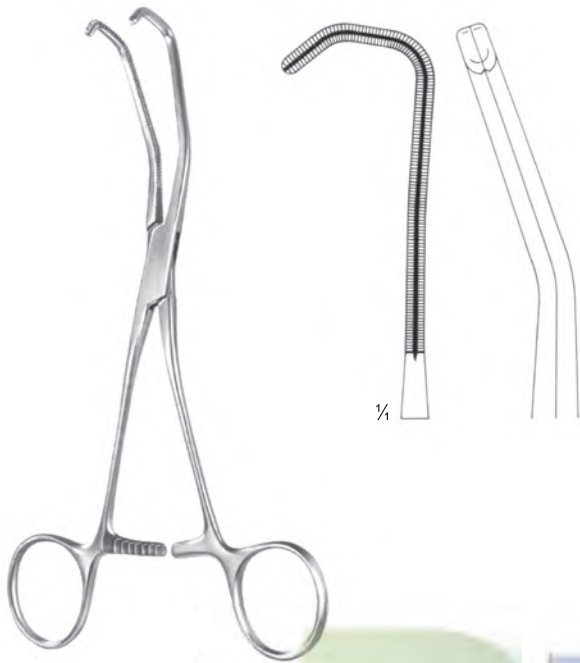

**COOLEY**  
 PC 19-5826-17  
 17 cm/6 3/4"



**COOLEY**  
 PC 19-5827-16  
 16 cm/6 1/4"



**COOLEY**  
 PC 19-5828-14  
 14 cm/5 1/2"



**COOLEY**  
 PC 19-5829-16  
 16 cm/6 1/4"



**COOLEY**  
 PC 19-5830-16  
 16.5 cm/6 1/2"



EN —● Multi purpose Vascular Clamps  
 DE —● Mehrzweck-Gefäßklemmen  
 ES —● Pinzas vasculares de usos múltiples

**ATRAUMA**



**COOLEY**  
PC 19-5831-17  
17 cm/6 3/4"



**COOLEY**  
PC 19-5832-17  
17 cm/6 3/4"



**COOLEY**  
PC 19-5833-17  
17.5 cm/6 7/8"

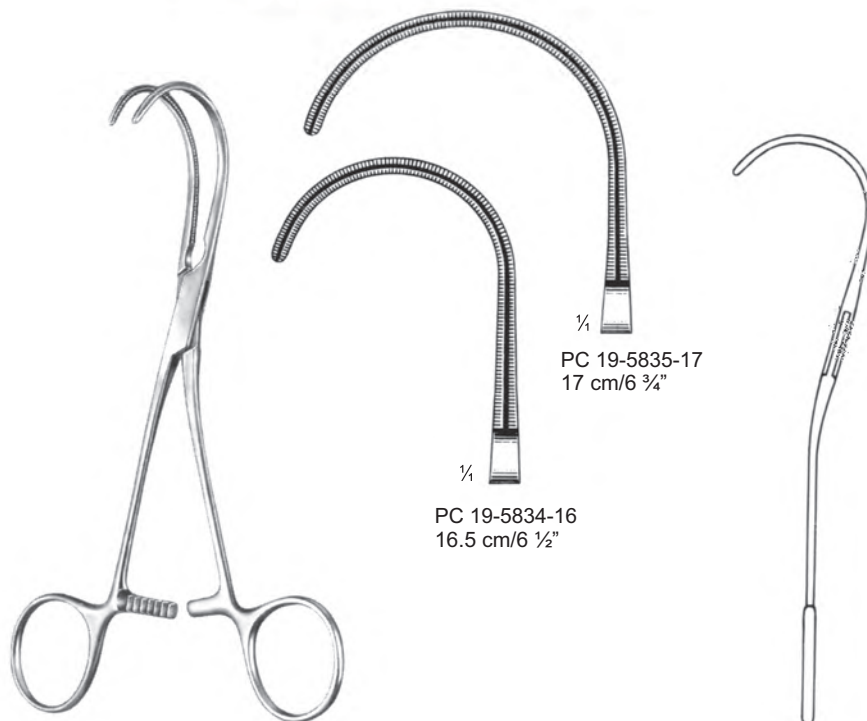

**COOLEY**  
PC 19-5834-16  
16.5 cm/6 1/2"

**PC 19-5835-17**  
17 cm/6 3/4"

- Anastomosis Clamps ●— EN
- Anastomosenklemme ●— DE
- Pinzas para anastomosis ●— ES

**ATRAUMA**



- EN —● Aortic Clamps
- DE —● Aortaklemmen
- ES —● Pinzas aórticas

**ATRAUMA**

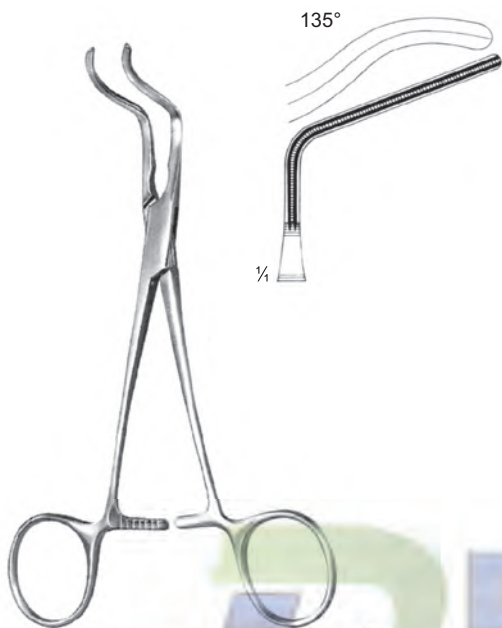

**SUBRAMANIAN-MINIATURE**  
PC 19-5840-15  
15.5 cm/6 1/8"

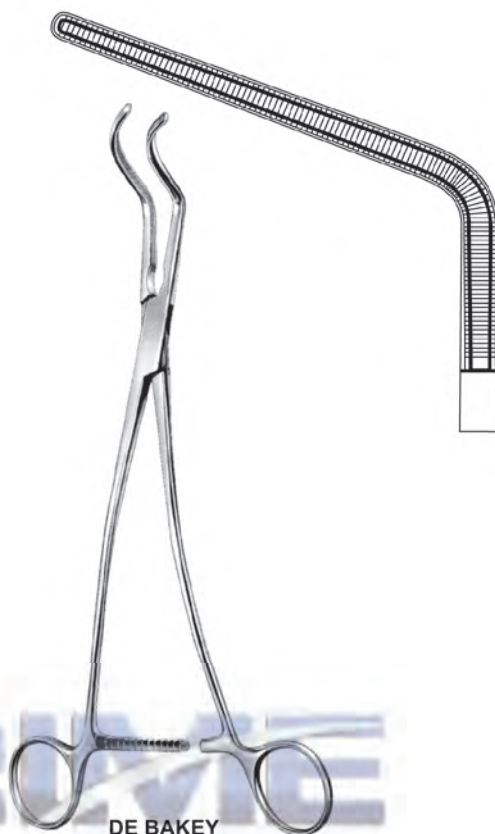

**DE BAKEY**  
PC 19-5840-27  
27.0cm



**SUBRAMANIAN**  
PC 19-5841-16  
16 cm/6 1/4"

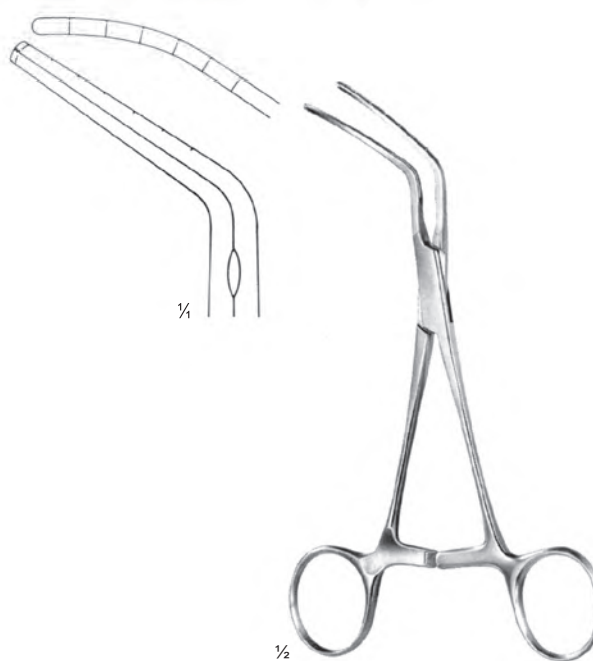

**SUBRAMANIAN**  
PC 19-5842-16  
16 cm/6 1/4"

Pediatric Vascular Clamps ●— EN  
 Kinder-Gefäßklemmen ●— DE  
 Pinzas vasculares pediátricas ●— ES

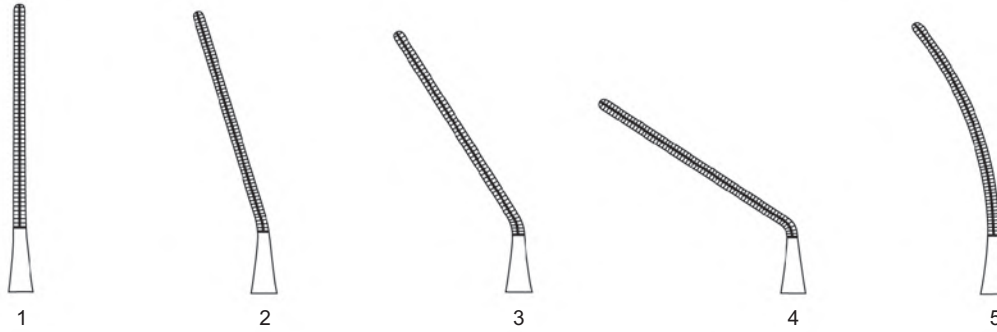

- 1 PC 19-5843-01 14.5cm
- 2 PC 19-5843-02 14.5cm
- 3 PC 19-5843-03 14.5cm
- 4 PC 19-5843-04 13.5cm
- 5 PC 19-5843-05 14.0cm
- 6 PC 19-5843-06 13.5cm
- 7 PC 19-5843-07 13.5cm
- 8 PC 19-5843-08 14.0cm
- 9 PC 19-5843-09 13.5cm

- 1 PC 19-5843-11 14.5cm
- 2 PC 19-5843-12 14.5cm
- 3 PC 19-5843-13 14.5cm
- 4 PC 19-5843-14 13.5cm
- 5 PC 19-5843-15 14.0cm
- 6 PC 19-5843-16 13.5cm
- 7 PC 19-5843-17 13.5cm
- 8 PC 19-5843-18 14.0cm
- 9 PC 19-5843-19 13.5cm

- 1 PC 19-5843-21 14.5cm
- 2 PC 19-5843-22 14.5cm
- 3 PC 19-5843-23 14.5cm
- 4 PC 19-5843-24 13.5cm
- 5 PC 19-5843-25 14.0cm
- 6 PC 19-5843-26 13.5cm
- 7 PC 19-5843-27 13.5cm
- 8 PC 19-5843-28 14.0cm
- 9 PC 19-5843-29 13.5cm

- EN — Pediatric Vascular Clamps
- DE — Kinder-Gefäßklemmen
- ES — Pinzas vasculares pediátricas

**ATRAUMA**

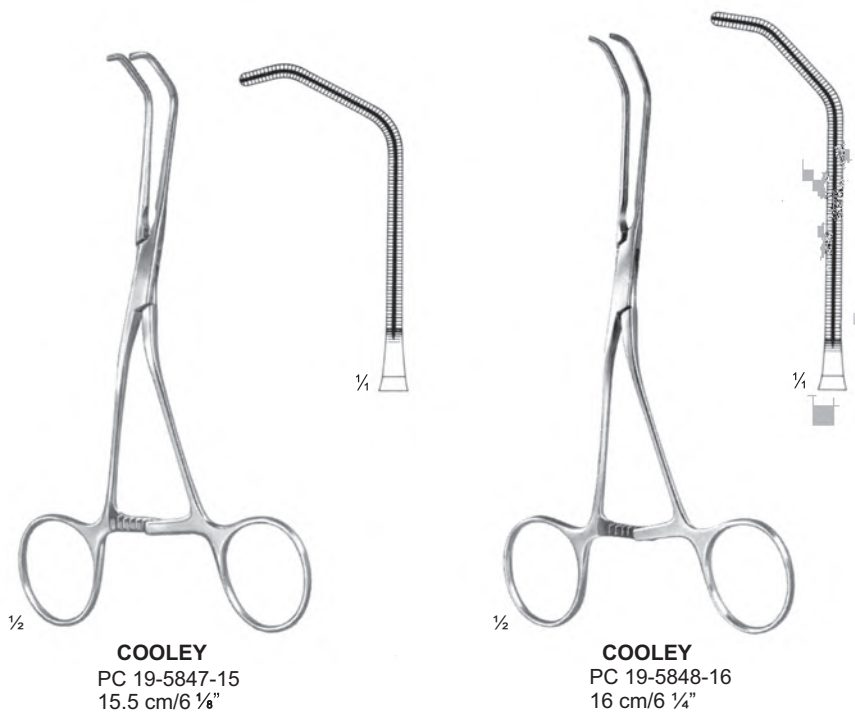



- Neonatal Vascular Clamps ● EN
- Neonatal-Gefäßklemmen ● DE
- Pinzas vasculares para recién nacidos ● ES

ATRAUMA



PC 19-5849-01  
12.5 cm/4 7/8"



PC 19-5849-02  
11.5 cm/4 1/2"



PC 19-5849-03  
11 cm/4 3/8"



CASTANEDA



PC 19-5849-04  
11.5 cm/4 1/2"

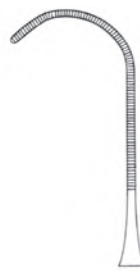

PC 19-5849-05  
12 cm/4 3/4"



PC 19-5849-06  
12 cm/4 3/4"



PC 19-5849-07  
12 cm/4 3/4"

EN —● Intestinal and Tissue Grasping Forceps

DE —● Darm- und Gewebefasszangen

ES —● Pinzas para intestinos y tejidos

**ATRAUMA**

- Intestinal and Tissue Grasping Forceps ●— EN
- Darm- und Gewebefasszangen ●— DE
- Pinzas para intestinos y tejidos ●— ES

ATRAUMA

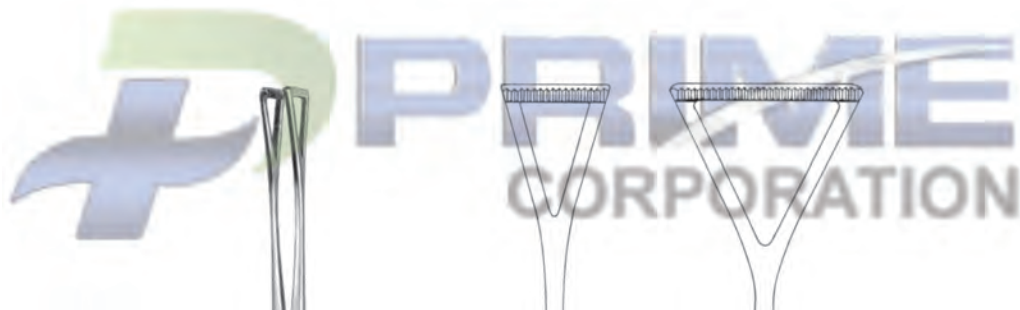

DUVAL

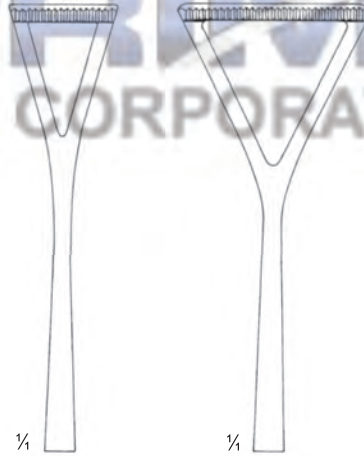

13 mm		25 mm
PC 19-5851-18	18 cm	PC 19-5852-18
PC 19-5851-20	20 cm	PC 19-5852-20
PC 19-5851-23	23 cm	PC 19-5852-23

- EN —● Organ Grasping Forceps
- DE —● Organfasszangen
- ES —● Pinzas para coger órganos

**ATRAUMA**



PC 19-5853-25  
25 cm/9 7/8"



PC 19-5853-26  
26 cm/10 1/4"



**SCHEIBE**



PC 19-5854-18  
18 cm/7 1/8"  
narrow



PC 19-5854-20  
20.5 cm/8 1/8"  
medium



PC 19-5854-23  
23 cm/9"  
wide

Intestinal Clamps ●— EN  
 Darmklemmen ●— DE  
 Pinzas intestinales ●— ES

**ATRAUMA**



**DOYEN-ATRAUMA**

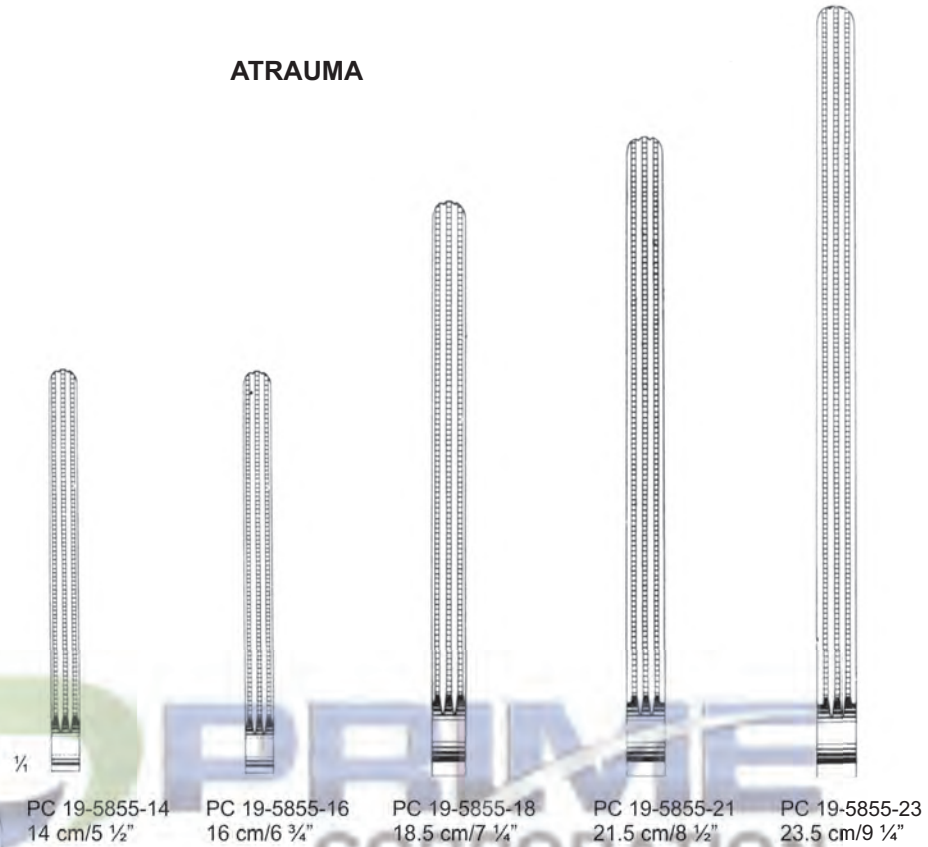

PC 19-5855-14 14 cm/5 1/2"  
 PC 19-5855-16 16 cm/6 3/4"  
 PC 19-5855-18 18.5 cm/7 1/4"  
 PC 19-5855-21 21.5 cm/8 1/2"  
 PC 19-5855-23 23.5 cm/9 1/4"



**DOYEN-ATRAUMA**

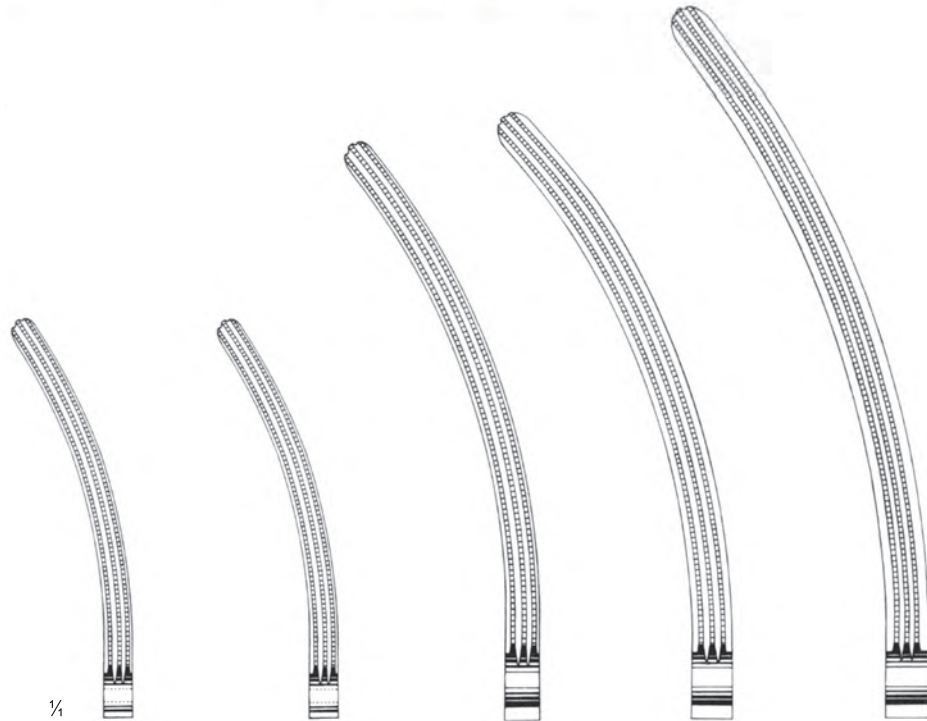

PC 19-5856-13 13.5 cm/5 3/8"  
 PC 19-5856-16 16 cm/6 3/4"  
 PC 19-5856-18 18 cm/7 1/8"  
 PC 19-5856-21 21 cm/8 1/4"  
 PC 19-5856-23 23 cm/9"



- EN —● Sigmoid Anastomosis Forceps
- DE —● Rektum-Anastomosenklemmen
- ES —● Pinzas para anastomosis rectales

**ATRAUMA**

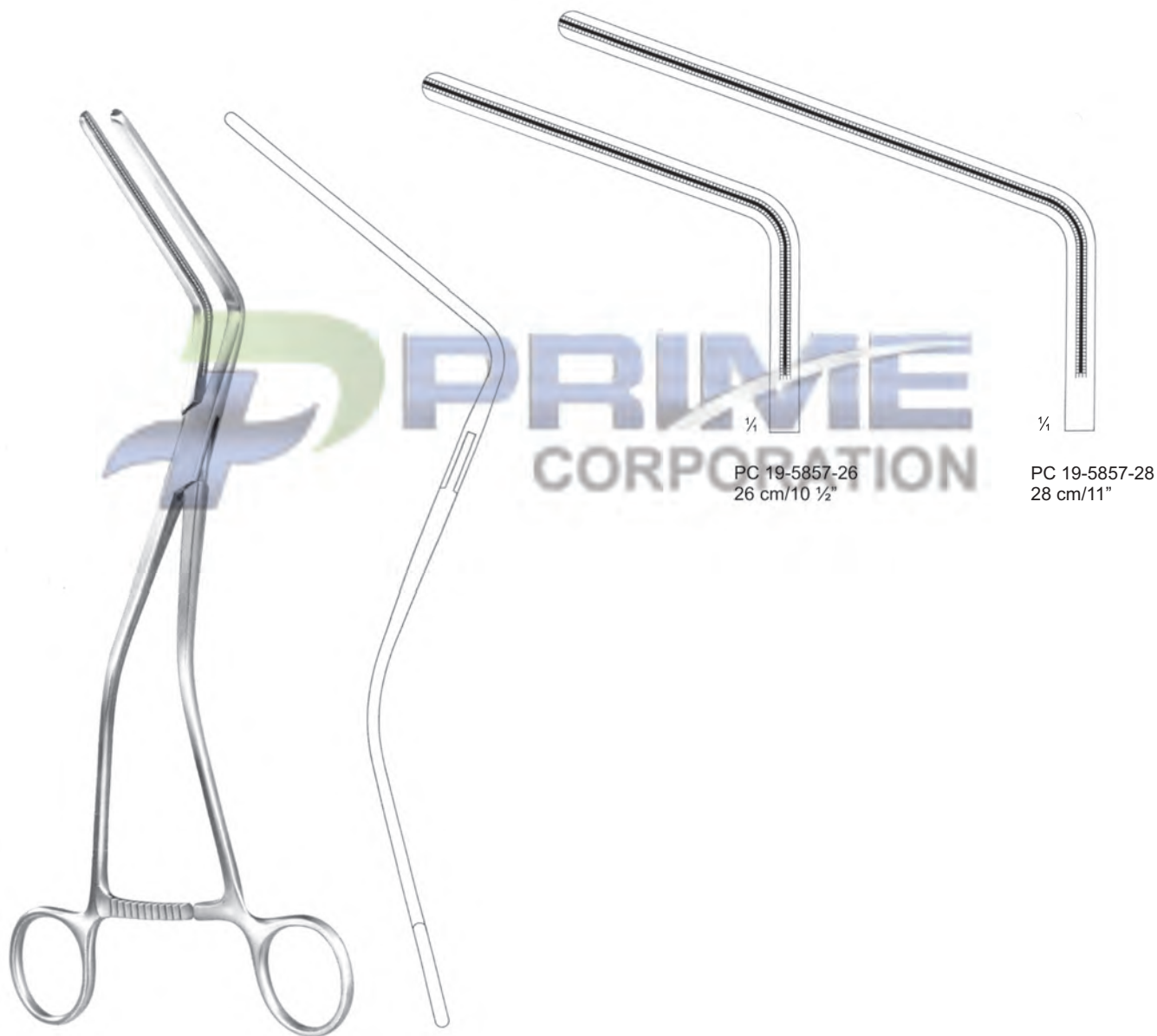

**HAYES**

- Sigmoid Anastomosis Forceps ● EN
- Rektum-Anastomosenklemmen ● DE
- Pinzas para anastomosis rectales ● ES

ATRAUMA



**VEIDENHEIMER**  
PC 19-5858-25  
25 cm/9 7/8"



**FEHLAND**  
PC 19-5859-24  
24 cm/9 1/2"

- EN —● Sigmoid Anastomosis Forceps  
 DE —● Rektum-Anastomosenklemmen  
 ES —● Pinzas para anastomosis rectales

**ATRAUMA**

**RESANO**  
 PC 19-5860-30  
 30 cm/12"



## **Pakistan Address**

**Mundeke-Berian, Pasrur  
Sialkot, Pakistan**

**Contact Person: Asif Munir Bajwa  
(Chief Executive)**

**Cell: +92 300 4201777**

**Telephone: +92 333 4201777**

**info@primesialkot.com**

**www.primesialkot.com**

## **Italy Address**

**Italy Office Via Cadorna, 2A  
39100-Bolzano (BZ)**

**Tel: +39 (0) 471 1818343**

**Cell: + 39 327 6243255**

**Email: info@primesialkot.com**

- EN** Tonsil  
**DE** Mandel  
**ES** Amígdala

Page 499 to 511





**TONSIL**

- EN —● Tonsil Needles and Ligature Carriers
- DE —● Tonsillennadeln, Ligature carrier
- ES —● Agujas para suturas de amígdalas, portalgaduras



Cleft Palate knives and tonsil knives ●— EN  
 Nadeln zur gaumennaht, Tonsillennadeln ●— DE  
 Agujas para suturas del paladar ●— ES



**ROTTER** PC 20-6160-01 26.0cm PC 20-6160-02  
**Fischer** PC 20-6161-22 22.5 cm/8<sup>7</sup>/<sub>8</sub>"  
**Douglas** PC 20-6162-21 21 cm/8<sup>1</sup>/<sub>4</sub>"  
**Abraham** PC 20-6163-21 21 cm/8<sup>1</sup>/<sub>4</sub>"  
**Bruenings** PC 20-6164-23 23 cm/9"  
**Tydins** PC 20-6165-21 21 cm

**Canfield** PC 20-6166-21 21 cm/8<sup>1</sup>/<sub>4</sub>"  
**Colver** PC 20-6167-22 22.5cm  
**Dupy-Weiss** PC 20-6168-01 22.0cm PC 20-6168-02PC 20-6169-20  
**Lynch** PC 20-6169-20 20.0cm  
**Carpenter** PC 20-6170-25 25.0cm  
**Carpenter** PC 20-6171-24 24.0cm  
**Marschik** PC 20-6172-22 22.0cm

- EN —● Tonsil Elevators and Retractors
- DE —● Tonsil Aufzüge und Retraktoren
- ES —● Elevadores de las amígdalas y retractores



**Negus Knot Tier and Pusher**  
PC 20-6173-20  
20cm/8"

**Molison Pillar**  
double ended  
PC 20-6174-21  
21cm/8 1/4"

**Gwynee Evans Dissector**  
double ended  
PC 20-6175-06  
6mm, 20cm/8"  
PC 20-6175-08  
8mm, 20cm/8"

**Hurd**  
PC 20-6176-22  
22.5 cm/8 7/8"

**Yankauer**  
PC 20-6177-21  
21 cm/8 1/4"

PC 20-6178-01

**Henke**  
23 cm/9"

PC 20-6178-02



**Nager**  
PC 20-6179-23  
23 cm/9"



Wide  
PC 20-6180-18 18 mm  
PC 20-6180-20 20 mm  
PC 20-6180-22 22 mm

**Love**  
23 cm/9"



**Haslinger**  
PC 20-6181-16



**Hofer**  
PC 20-6182-24  
24 cm/9 1/2"

Tonsil Seizing Forceps ● EN  
 Tonsillenzangen ● DE  
 Pinzas para coger las amígdalas ● ES

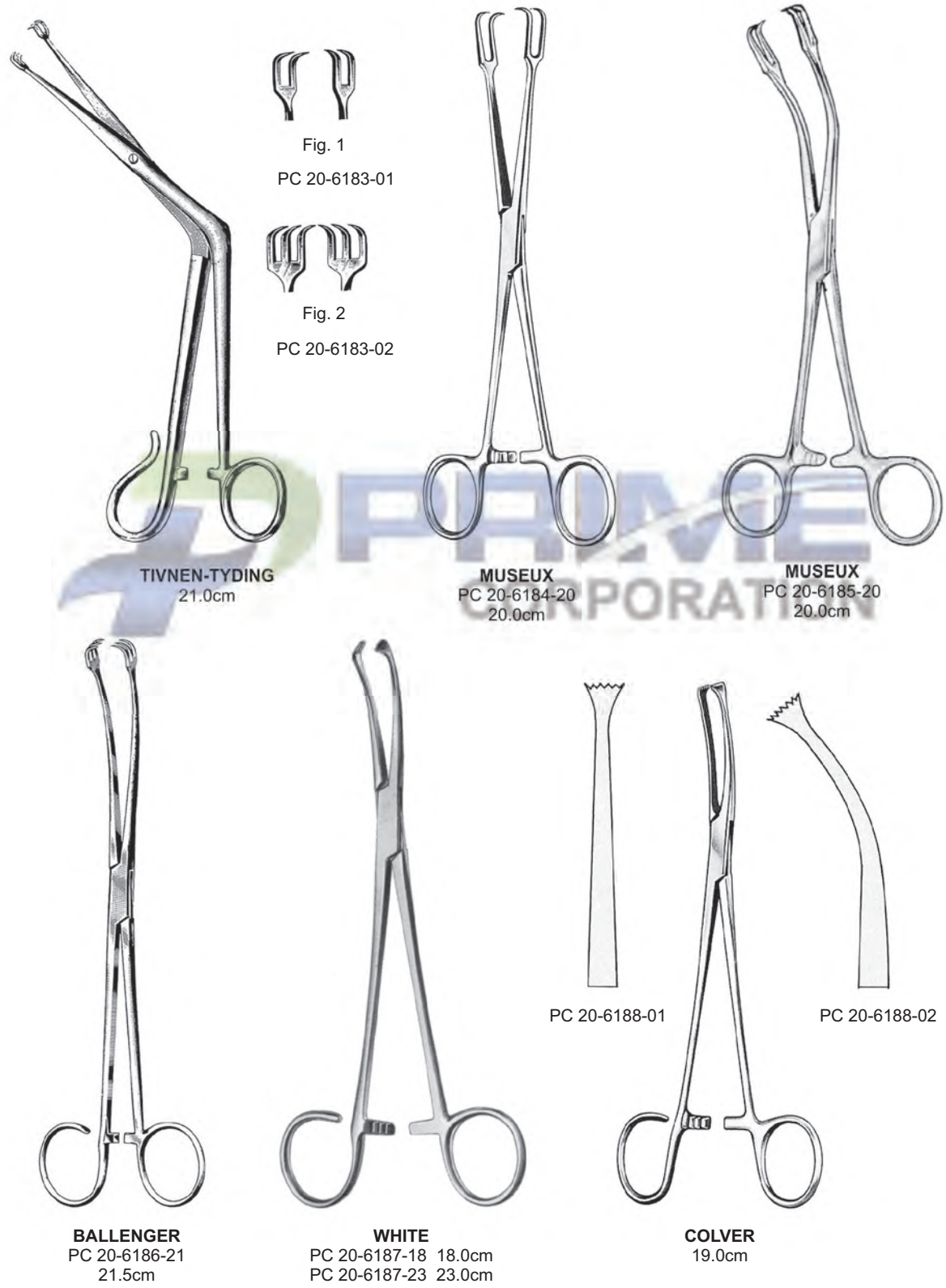



**TONSIL**

- EN —● Tonsil Haemostatic and Abscess Holding Forceps
- DE —● Tonsil Haemostatic und Abszessbesitzzange
- ES —● La amigdala haemostatic yel absceso que tienen fórceps

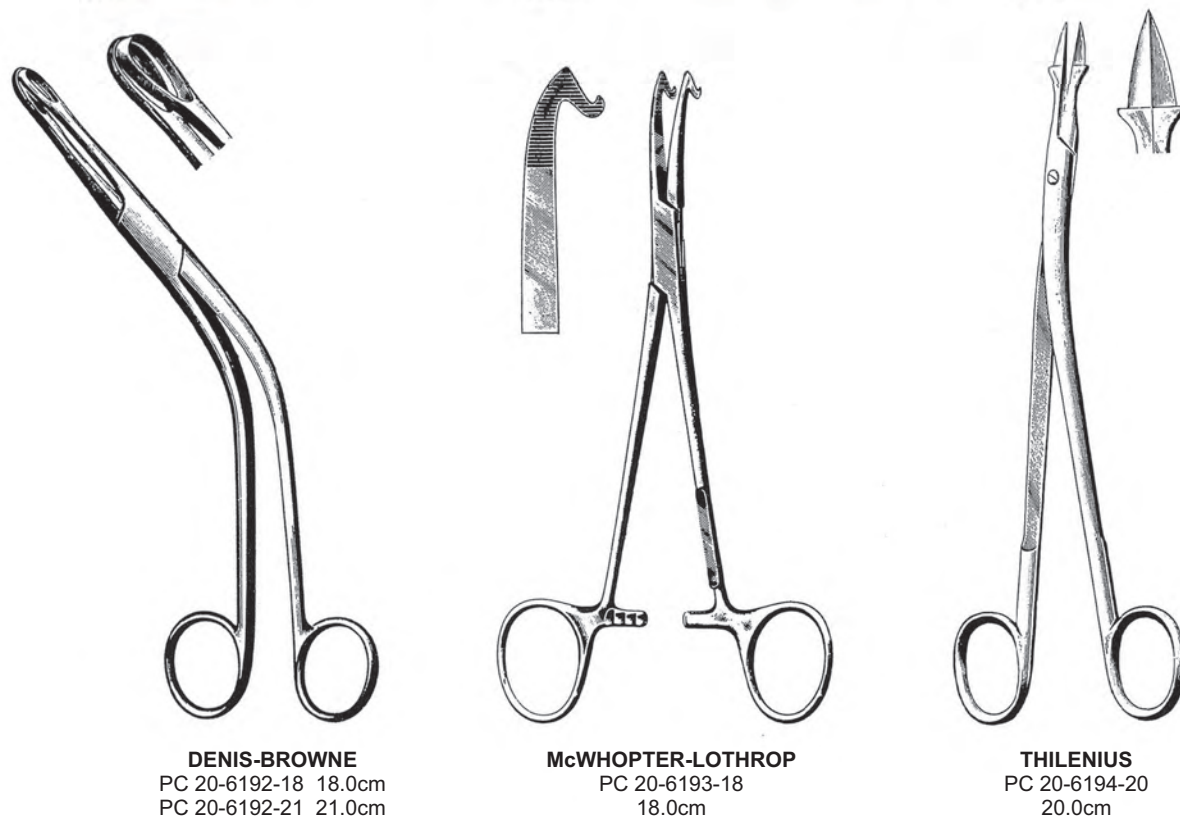



Tonsil Seizing Forceps ● EN  
 Tonsillenzangen ● DE  
 Pinzas para coger las amígdalas ● ES

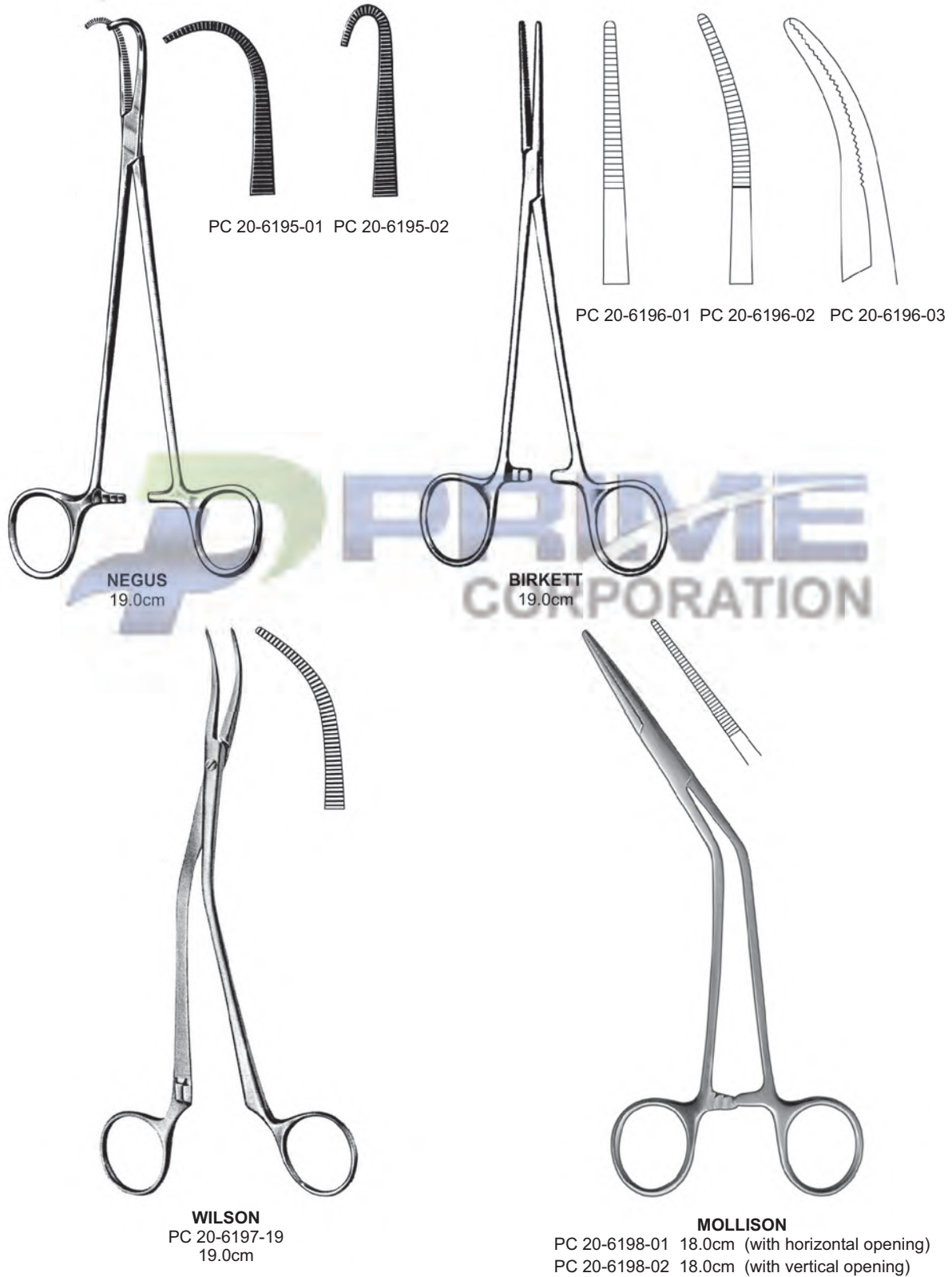

- EN —● Tonsil Snares
- DE —● Tonsillenschnürer
- ES —● Cierra-nudos para amígdalas

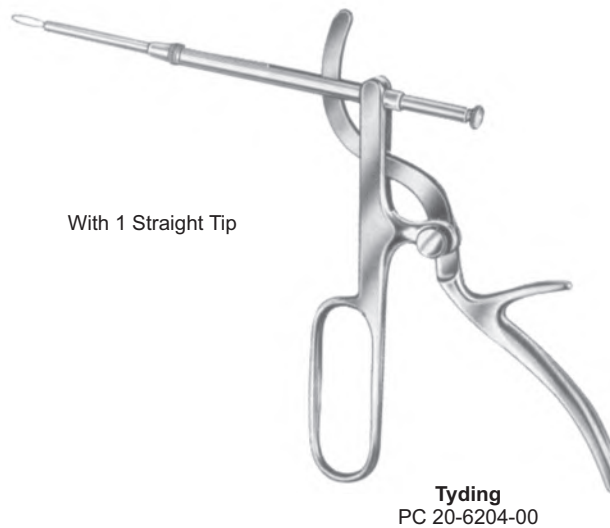
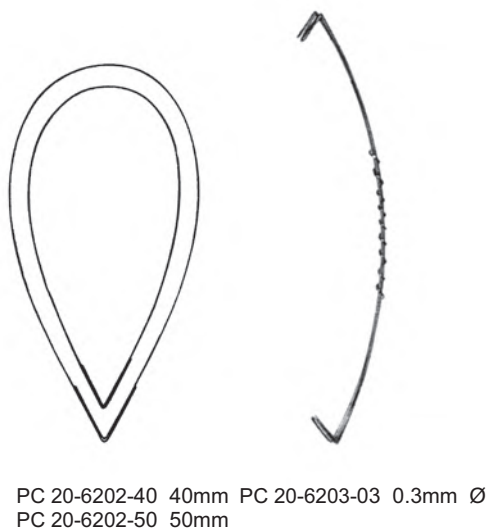
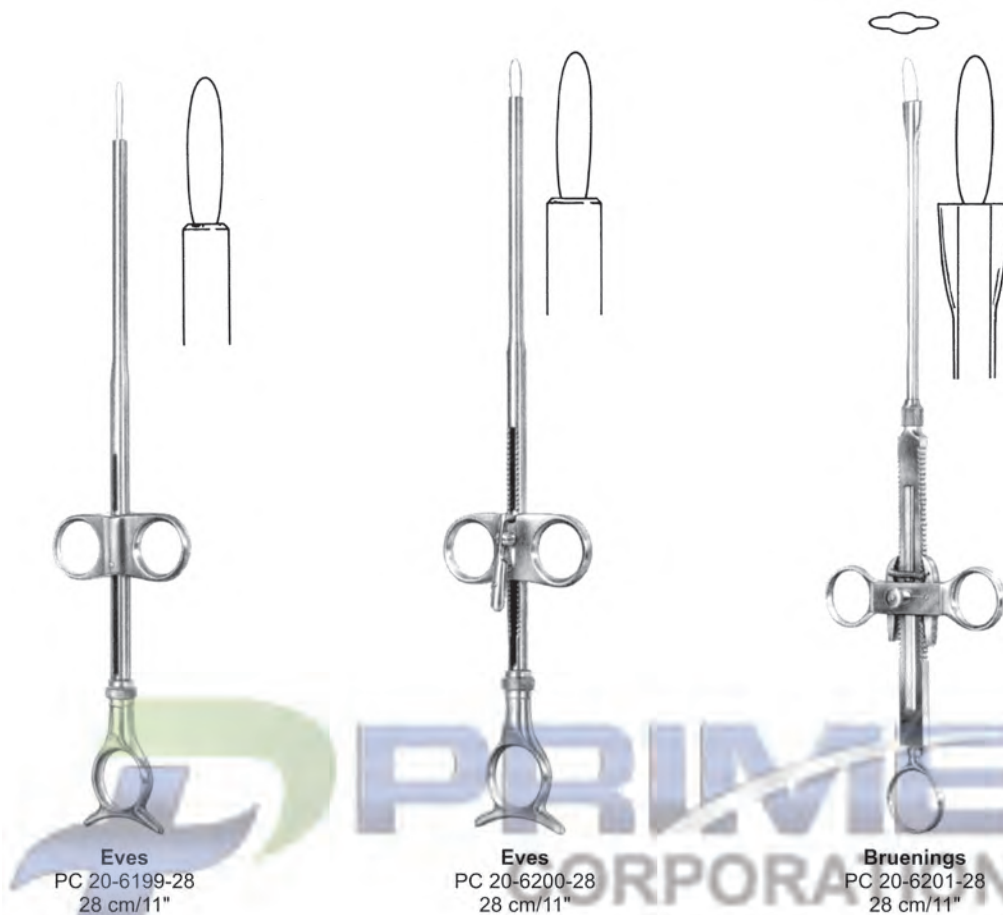

Tonsillectomes ● EN  
 Tonsillotome ● DE  
 Amigdalótomos ● ES

Tonsil Haemostats



PC 20-6205-01    PC 20-6205-02    PC 20-6205-03



**Sluder-Ballenger**  
 Complete, With 3 Tips  
 PC 20-6205-00



**Corwin**  
 PC 20-6206-14  
 14 cm/5½"



Tonsil Punch Forceps



PC 20-6207-13 13 mm/O  
 PC 20-6207-15 15 mm/O  
 PC 20-6207-17 17 mm/O

**Hartmann**



**Luc Forceps**  
 PC 20-6208-01 Small  
 PC 20-6208-02 Medium  
 PC 20-6208-03 Large  
 20cm/8"

- EN —● Mirror Handle, Forceps, Scissors  
 DE —● Spiegel Griff, Pinzetten, Scheren  
 ES —● Mango de espejo, pinzas, tijeras



**Waugh Dissecting Forcep**  
 PC 20-6209-20  
 1 x 2 teeth  
 20cm/8"



**Waugh Dissecting Forcep**  
 PC 20-6210-20  
 serrated  
 20cm/8"



**Metzenbaum Scissor Cvd.**  
 PC 20-6211-18  
 18cm/7"

- Broncho-Esophagoscopy Forceps ● EN
- Broncho-Oesophagoskopiezangen ● DE
- pinzas para bronco-esofagoscopia ● ES

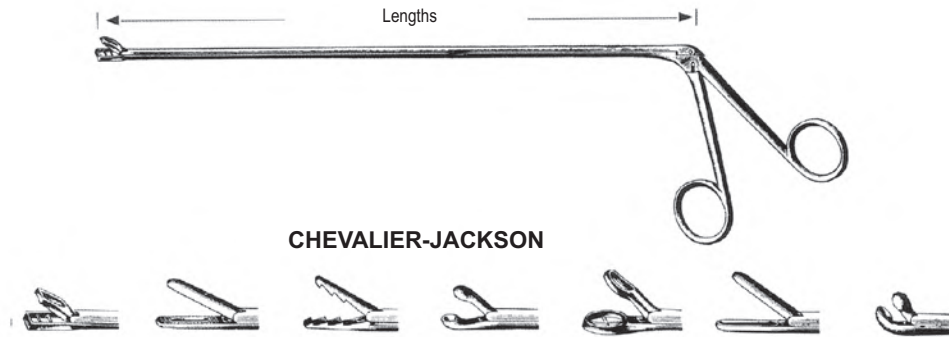

30.0cm	PC 20-6212-30	PC 20-6213-30	PC 20-6214-30	PC 20-6215-30	PC 20-6216-30	PC 20-6217-30	PC 20-6218-30
40.0cm	PC 20-6212-40	PC 20-6213-40	PC 20-6214-40	PC 20-6215-40	PC 20-6216-40	PC 20-6217-40	PC 20-6218-40
50.0cm	PC 20-6212-50	PC 20-6213-50	PC 20-6214-50	PC 20-6215-50	PC 20-6216-50	PC 20-6217-50	PC 20-6218-50
60.0cm	PC 20-6212-60	PC 20-6213-60	PC 20-6214-60	PC 20-6215-60	PC 20-6216-60	PC 20-6217-60	PC 20-6218-60



**BRUENINGS (straight)**  
 PC 20-6219-20 20.0cm  
 PC 20-6219-30 30.0cm  
 PC 20-6219-40 40.0cm  
 PC 20-6219-50 50.0cm  
 PC 20-6219-60 60.0cm





- EN —● Cutting and Grasping Forceps Tips
- DE —● Auswechselbare Zangenaufsätze
- ES —● Pinzas intercambiables



**FRAENKEL**  
PC 20-6222-00



**BARACANI**  
PC 20-6223-00



**SEIFFERT**  
PC 20-6224-00



**FRAENKEL**  
PC 20-6225-00



**BRUENINGS**  
PC 20-6226-01  
PC 20-6226-02



**BRUENINGS**  
PC 20-6227-01  
PC 20-6227-02



**LANGE**  
PC 20-6228-00



**KRAUSE**  
PC 20-6229-01  
PC 20-6229-02



**SCHUMACHER**  
PC 20-6230-00



**CORDES**  
PC 20-6231-01  
PC 20-6231-02



**CORDES**  
PC 20-6232-00



**ROSENBERG**  
PC 20-6233-00



**KRAUSE**  
PC 20-6234-00



**CORDES**  
PC 20-6235-01  
PC 20-6235-02  
PC 20-6235-03  
PC 20-6235-04



**SCHEINMANN**  
PC 20-6236-00



**SCHEINMANN**  
PC 20-6237-00

Laryngeal Handles and Mirrors ● EN  
 Laryngeal Behandelt und Spiegelt wider ● DE  
 Los maneja y espejos laríngeos ● ES



PC 20-6238-11



PC 20-6239-10



PC 20-6240-11



PC 20-6241-12



PC 20-6242-00



**MICHEL**  
25.0cm



PC 20-6243-12 PC 20-6243-14 PC 20-6243-16 PC 20-6243-18



PC 20-6244-08	fig.00, 8mm Ø	PC 20-6245-08
PC 20-6244-10	fig.0, 10mm Ø	PC 20-6245-10
PC 20-6244-12	fig.1, 12mm Ø	PC 20-6245-12
PC 20-6244-14	fig.2, 14mm Ø	PC 20-6245-14
PC 20-6244-16	fig.3, 16mm Ø	PC 20-6245-16
PC 20-6244-18	fig.4, 18mm Ø	PC 20-6245-18
PC 20-6244-20	fig.5, 20mm Ø	PC 20-6245-20
PC 20-6244-22	fig.6, 22mm Ø	PC 20-6245-22
PC 20-6244-24	fig.7, 24mm Ø	PC 20-6245-24
PC 20-6244-26	fig.8, 26mm Ø	PC 20-6245-26
PC 20-6244-28	fig.9, 28mm Ø	PC 20-6245-28
PC 20-6244-30	fig.10, 30mm Ø	PC 20-6245-30

**TONSIL**

- EN —● Laryngeal Polypus Forceps
- DE —● Kehlkopfpolypenzangen
- ES —● Pinzas para polipos laringeos



PC 20-6246-01



PC 20-6246-02



PC 20-6246-03



PC 20-6246-04



**JURASZ**  
23.0cm

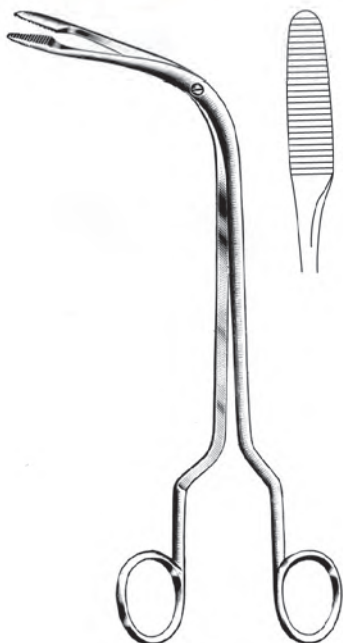

**FRAENKEL**  
PC 20-6247-19  
19.0cm



**JACKSON**  
22.0cm



PC 20-6248-22 PC 20-6248-22



**REICHERT**  
PC 20-6249-24  
24.0cm

**EN** Otology

**DE** Otologie

**ES** Otología

**Page 512 to 540**



EN —● Ear Speculas  
 DE —● Ohrspekula  
 ES —● Espéculos auriculares



**TROELTSCH**  
 PC 21-6301-00 set/3  
 PC 21-6301-01 6mm Ø, Fig. 1  
 PC 21-6301-02 7mm Ø, Fig. 2  
 PC 21-6301-03 8mm Ø, Fig. 3



**HARTMANN (for children)**  
 PC 21-6302-00 set/3  
 PC 21-6302-01 4mm Ø, Fig. 1  
 PC 21-6302-02 5mm Ø, Fig. 2



**HARTMANN (for adults)**  
 PC 21-6303-00 set/4  
 PC 21-6303-01 4.0mm Ø, Fig. 1  
 PC 21-6303-02 5.0mm Ø, Fig. 2  
 PC 21-6303-03 6.0mm Ø, Fig. 3  
 PC 21-6303-04 7.5mm Ø, Fig. 4



**TOYNBEE (for adults)**  
 PC 21-6304-00 set/4  
 PC 21-6304-01 4mm Ø, Fig. 1  
 PC 21-6304-02 5mm Ø, Fig. 2  
 PC 21-6304-03 6mm Ø, Fig. 3  
 PC 21-6304-04 7mm Ø, Fig. 4



**GRUBER (for adults)**  
 PC 21-6305-00 set/4  
 PC 21-6305-01 4.5mm Ø, Fig. 1  
 PC 21-6305-02 5.5mm Ø, Fig. 2  
 PC 21-6305-03 6.5mm Ø, Fig. 3  
 PC 21-6305-04 7.5mm Ø, Fig. 4



**GRUBER**  
 PC 21-6306-00 set/4  
 PC 21-6306-01 4.5mm Ø, Fig. 1  
 PC 21-6306-02 5.5mm Ø, Fig. 2  
 PC 21-6306-03 6.5mm Ø, Fig. 3  
 PC 21-6306-04 7.5mm Ø, Fig. 4



**GRUBER**  
 PC 21-6307-00 set/4  
 PC 21-6307-01 4.5mm Ø, Fig. 1  
 PC 21-6307-02 5.5mm Ø, Fig. 2  
 PC 21-6307-03 6.5mm Ø, Fig. 3  
 PC 21-6307-04 7.5mm Ø, Fig. 4

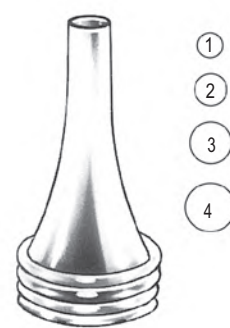

**POLITZER**  
 PC 21-6308-00 set/4  
 PC 21-6308-01 3.0mm Ø, Fig. 1  
 PC 21-6308-02 4.5mm Ø, Fig. 2  
 PC 21-6308-03 5.5mm Ø, Fig. 3  
 PC 21-6308-04 6.5mm Ø, Fig. 4



Ear Speculas ●— EN  
 Ohrspekula ●— DE  
 Espéculos auriculares ●— ES



**ERHARDT**

PC 21-6309-00 set/3  
 PC 21-6309-01 4.5mm Ø, Fig. 1  
 PC 21-6309-02 5.5mm Ø, Fig. 2  
 PC 21-6309-03 6.5mm Ø, Fig. 3

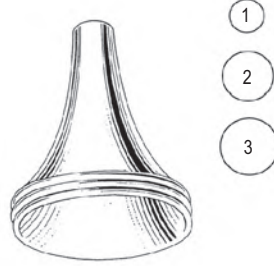

**PRITCHARD**

PC 21-6310-00 set/3  
 PC 21-6310-01 4.5mm Ø, Fig. 1  
 PC 21-6310-02 6.5mm Ø, Fig. 2  
 PC 21-6310-03 7.5mm Ø, Fig. 3



**BOUCHERON**

PC 21-6311-00 set/5  
 PC 21-6311-01 4.0mm Ø, Fig. 1  
 PC 21-6311-02 5.0mm Ø, Fig. 2  
 PC 21-6311-03 6.0mm Ø, Fig. 3  
 PC 21-6311-04 7.0mm Ø, Fig. 4  
 PC 21-6311-05 8.0mm Ø, Fig. 5



**ZÖLLNER**

PC 21-6312-00 set/6  
 PC 21-6312-01 5.5x6.5mm Ø, Fig. 1  
 PC 21-6312-02 6.5x7.5mm Ø, Fig. 2  
 PC 21-6312-03 7.5x8.5mm Ø, Fig. 3  
 PC 21-6312-04 8.5x9.5mm Ø, Fig. 4  
 PC 21-6312-05 9.5x10.5mm Ø, Fig. 5  
 PC 21-6312-06 10.5x11.5mm Ø, Fig. 6

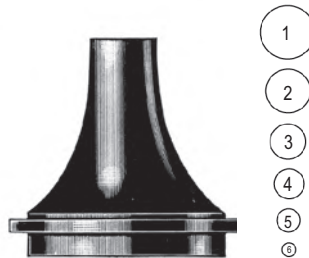

**RICHAU HOLMGREN**

PC 21-6314-02 Ø 2mm  
 PC 21-6314-03 Ø 3mm  
 PC 21-6314-04 Ø 4mm  
 PC 21-6314-05 Ø 5mm  
 PC 21-6314-06 Ø 6mm

- EN —● Ear Speculas
- DE —● Ohrspekula
- ES —● Espéculos auriculares

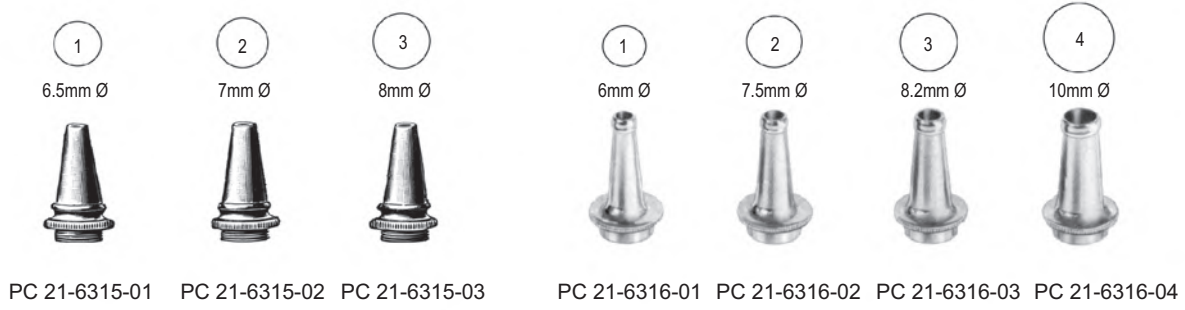

**SIEGLE**  
 PC 21-6315-00 set  
 PC 21-6315-04 otoscope  
 PC 21-6315-05 rubber bulb  
 PC 21-6315-01,02,03 speculas



PC 21-6316-00 Compl.



**BRUENINGS**  
 PC 21-6316-05 set of 4 speculas  
 PC 21-6316-06 rubber bulb  
 PC 21-6316-07 wooden case only  
 PC 21-6316-10 otoscope

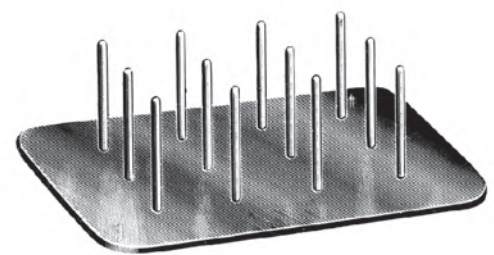

PC 21-6317-01  
 support for specula

Ear Speculas ●— EN  
 Ohrspekula ●— DE  
 Espéculos auriculares ●— ES

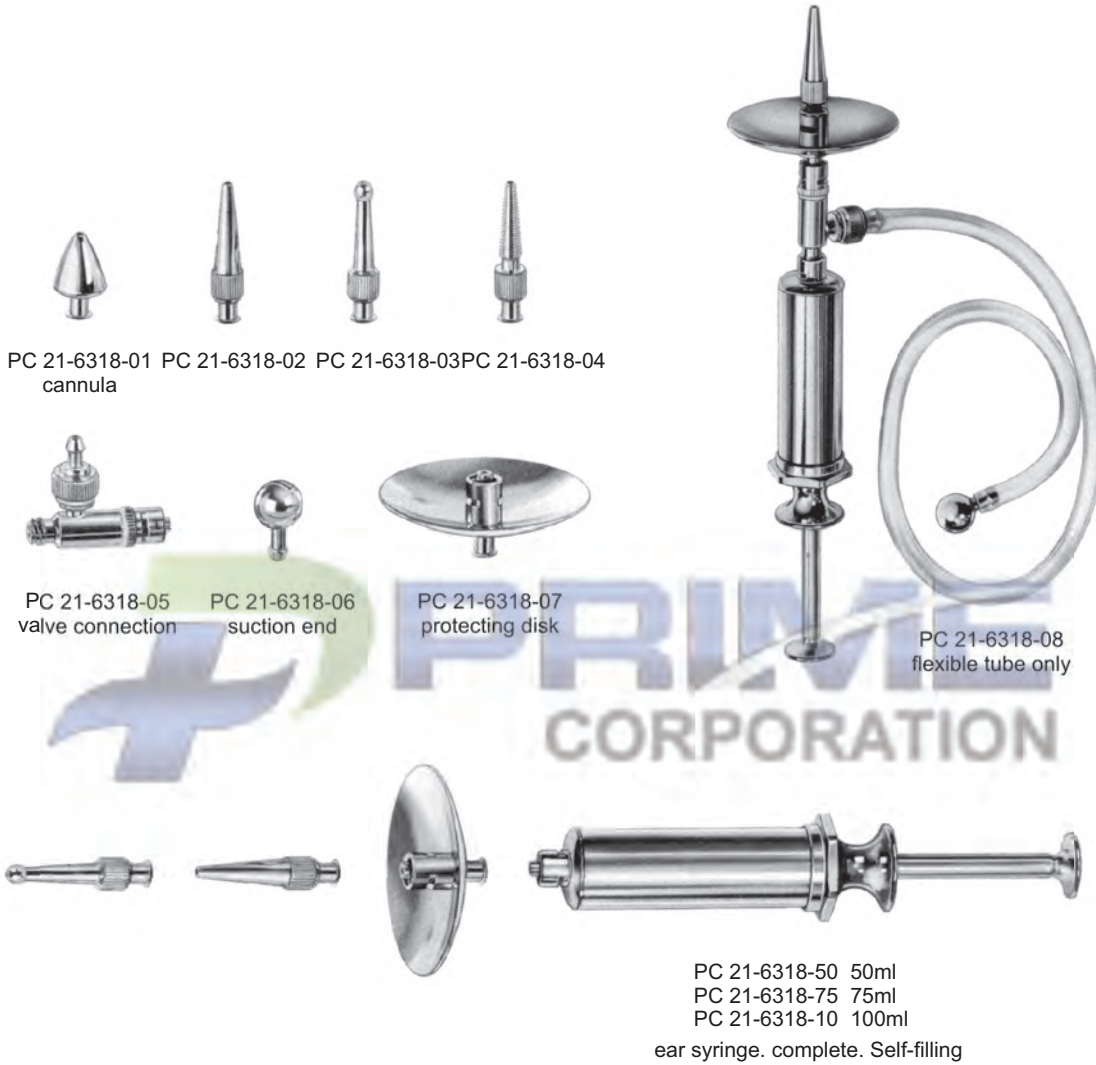

PC 21-6318-01 PC 21-6318-02 PC 21-6318-03 PC 21-6318-04  
 cannula

PC 21-6318-05  
 valve connection

PC 21-6318-06  
 suction end

PC 21-6318-07  
 protecting disk

PC 21-6318-08  
 flexible tube only

PC 21-6318-50 50ml  
 PC 21-6318-75 75ml  
 PC 21-6318-10 100ml  
 ear syringe. complete. Self-filling

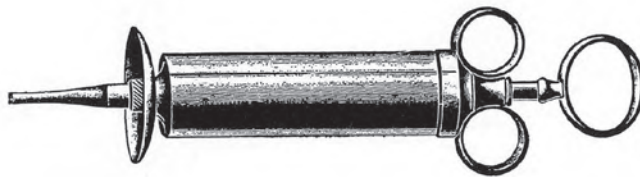

PC 21-6319-01 bulb tip  
 PC 21-6319-02 conical tip  
 PC 21-6319-03 shield

**LUER**  
 PC 21-6319-04  
 PC 21-6319-05  
 PC 21-6319-06

**PIMERROY**  
 PC 21-6319-50 50cc  
 PC 21-6319-75 75cc  
 PC 21-6319-10 100cc  
 PC 21-6319-15 150cc  
 PC 21-6319-20 200cc

**LUER**  
 PC 21-6319-50A  
 PC 21-6319-75A  
 PC 21-6319-10A  
 PC 21-6319-15A  
 PC 21-6319-20A

EN —●— Tuning Forks  
 DE —●— Stimmgabeln  
 ES —●— Diapasones

Tuning Forks

16						
32						
64						
128	PC 21-6320-00	PC 21-6321-00	PC 21-6322-16	PC 21-6323-00	PC 21-6324-00	PC 21-6325-00
256	PC 21-6320-01	PC 21-6321-01	PC 21-6322-32			C 64/C 128
512	PC 21-6320-02	PC 21-6321-02	PC 21-6322-01			
1024	PC 21-6320-03	PC 21-6321-03	PC 21-6322-02			
2048	PC 21-6320-04	PC 21-6321-04	PC 21-6322-03			
4096	PC 21-6320-05	PC 21-6321-05				

PC 21-6327-01	PC 21-6327-02	PC 21-6327-03	PC 21-6327-04	PC 21-6327-05	PC 21-6327-06	PC 21-6327-07
C 64	C 128	C 256	C 512 aluminum	C 1024 aluminum	C 2048 aluminum	C 4096 aluminum

With Clamps = C 64  
 Without Clamps = C 128

Tuning Fork for neurological examination, with percussion hammer, pin wheel, brush and needle  
 PC 21-6326-00



Eustachian Catheters and Suction Instruments — EN  
 Eustachian Katheter und Sauginstrumente — DE  
 catéteres e instrumentos de succión Eustachin — ES

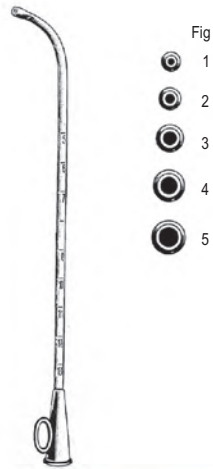

**TROELTSCH**  
 PC 21-6328-01 Fig. 1  
 PC 21-6328-02 Fig. 2  
 PC 21-6328-03 Fig. 3  
 PC 21-6328-04 Fig. 4  
 PC 21-6328-05 Fig. 5

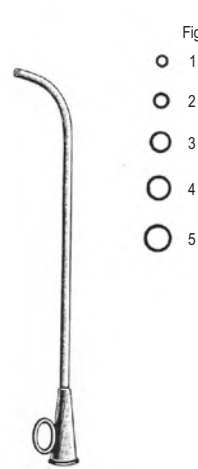

**LUCAE**  
 PC 21-6329-01 Fig. 1  
 PC 21-6329-02 Fig. 2  
 PC 21-6329-03 Fig. 3  
 PC 21-6329-04 Fig. 4  
 PC 21-6329-05 Fig. 5



**WOKES**  
 PC 21-6330-01

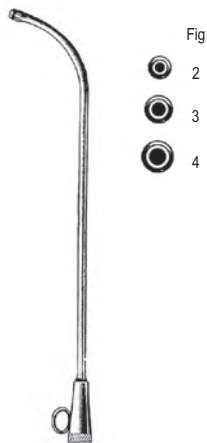

**HARTMANN**  
 PC 21-6331-02 Fig. 2  
 PC 21-6331-03 Fig. 3  
 PC 21-6331-04 Fig. 4

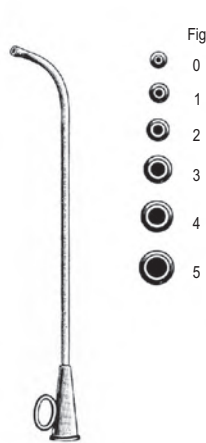

**HARTMANN**  
 PC 21-6332-00 Fig. 0  
 PC 21-6332-01 Fig. 1  
 PC 21-6332-02 Fig. 2  
 PC 21-6332-03 Fig. 3  
 PC 21-6332-04 Fig. 4  
 PC 21-6332-05 Fig. 5

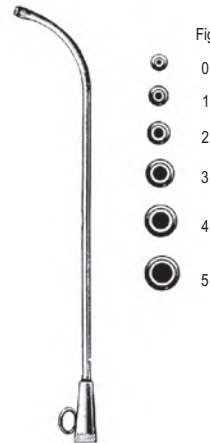

**HARTMANN**  
 PC 21-6333-00 Fig. 0  
 PC 21-6333-01 Fig. 1  
 PC 21-6333-02 Fig. 2  
 PC 21-6333-03 Fig. 3  
 PC 21-6333-04 Fig. 4  
 PC 21-6333-05 Fig. 5

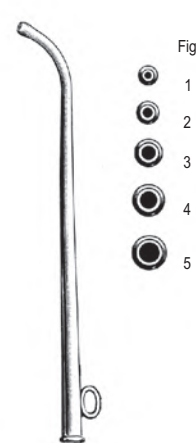

**ITARD**  
 PC 21-6334-01 Fig. 1  
 PC 21-6334-02 Fig. 2  
 PC 21-6334-03 Fig. 3  
 PC 21-6334-04 Fig. 4  
 PC 21-6334-05 Fig. 5



- EN —● Ear Polypus Snares and Ear Dressing Forceps
- DE —● Polypenschnürer, Ohrpinzetten
- ES —● Polipótomos, Pinzas auriculares



**Krause**  
PC 21-6335-16  
16 cm/6 1/4"



**Krause-Voss**  
PC 21-6336-16  
16 cm/6 1/4"



**Lange-Wilde**  
PC 21-6337-16  
16 cm/6 1/4"



Package of 1 dozen each  
mm Ø  
PC 21-6338-02 0.2  
PC 21-6338-03 0.3



PC 21-6338-03 0.3mm Ø  
PC 21-6338-04 0.4mm Ø



**TROELTSCH (WILDE)**  
PC 21-6339-13 13.0cm

Ear Dressing Forceps



**Troeltsch (Wilde)**  
PC 21-6340-11  
PC 21-6340-12  
PC 21-6340-14  
PC 21-6340-15

**Troeltsch**  
1 x 2 teeth  
PC 21-6343-11  
PC 21-6343-12



**Lucae**  
PC 21-6344-14



**Lucae**  
1 x 2 teeth  
PC 21-6345-14



**Jansen**  
PC 21-6346-16  
PC 21-6346-18  
PC 21-6346-20

Cm	In
11.0	4 1/4"
12.0	4 3/4"
14.0	5 1/2"
15.0	6"
16.0	6 1/4"
18.0	7"
20.0	8"

Eustachin Catheters and Suction Instruments ●— EN  
 Eustachin Katheter und Sauginstrumente ●— DE  
 catéteres e instrumentos de succión Eustachin ●— ES



**Okonogto**  
 PC 21-6347-16  
 16 cm/6 1/4"

**Littauer**  
 PC 21-6348-12  
 12 cm/4 3/4"

**Hartmann**  
 PC 21-6349-12  
 12 cm/4 3/4"

**Hartmann**  
 PC 21-6350-14  
 14 cm/5 1/2"

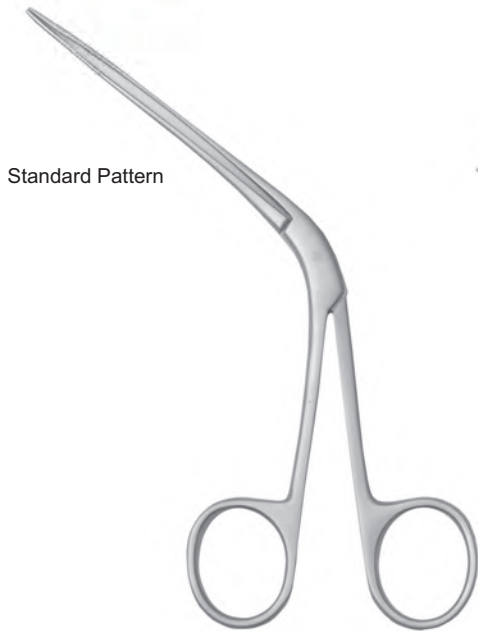

Standard Pattern

**Tilley Aural Forcep**  
 PC 21-6351-14 14cm/5 1/2"  
 PC 21-6351-16 16cm/6 1/4"  
 PC 21-6351-18 18cm/7"



**Buck**  
 PC 21-6352-09  
 9 cm/3 1/2"



**Quire**  
 PC 21-6353-08  
 8 cm/3 1/4"

- EN —● Ear Polypus Forceps
- DE —● Ohr-Polypenzangen
- ES —● Pinzas para pólipos auriculares



**Hartmann-Noyes**  
PC 21-6354-09  
8.5 cm/3¼"



**Hartmann-Noy<sup>es</sup>**  
PC 21-6355-09  
8.5 cm/3¼"



**Hartmann**  
PC 21-6356-09 8.5 cm/3¼"  
PC 21-6356-14 14 cm/5½"  
PC 21-6356-16 16 cm/6¼"

1 : 2



**Hartmann**  
PC 21-6357-09 8.5 cm/3¼"  
PC 21-6357-14 14.0 cm/5½"



**Hartmann**  
PC 21-6358-20 8.5 cm/3¼" ○ 2.0 mm  
PC 21-6358-25 8.5 cm/3¼" ○ 2.5 mm  
PC 21-6358-30 8.5 cm/3¼" ○ 3.0 mm



**Hartmann-Citelli**  
PC 21-6359-02 ○ 2 mm 8.5 cm/3¼"  
PC 21-6359-03 ○ 3 mm 8.5 cm/3¼"



**Strumpel**  
PC 21-6360-09  
8.5 cm/3¼"



**Hartamm-Weingartner**  
PC 21-6361-09  
8.5 cm/3¼"



**HARTMANN**  
PC 21-6361-10 8.5cm



**Hartamm**  
PC 21-6362-09  
8.5 cm/3¼"



**Hartamm-Wullstein**  
PC 21-6363-06 8.5 cm/3¼" 08 x 6 mm  
PC 21-6363-08 8.5 cm/3¼" 1.8 x 8 mm



**HARTMANN**  
PC 21-6363-09 8.5cm



**Hartamm-Hoffmann**  
PC 21-6364-01 ○ 1 mm 8.5 cm/3¼"  
PC 21-6364-02 ○ 2 mm 8.5 cm/3¼"

Micro Ear Polypus Forceps ● EN  
 Ohr-Polypenzangen ● DE  
 Pinzas para pólipos auriculares ● ES

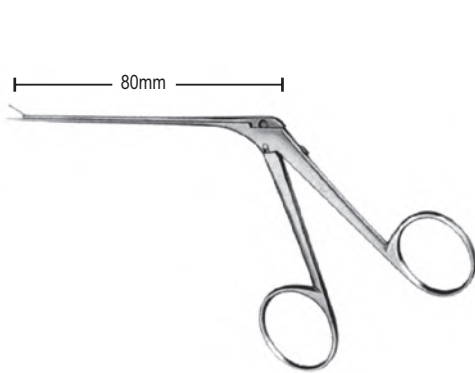

**MINI McGEE ALLIGATOR**



PC 21-6365-01  
4.0 x 0.8mm  
straight, smooth



PC 21-6365-02  
4.0 x 0.8mm  
straight, serrated



PC 21-6365-03  
4.0 x 0.8mm  
curved up



PC 21-6365-04  
4.0 x 0.8mm  
right



PC 21-6365-05  
4.0 x 0.8mm  
left



PC 21-6365-06  
3.5 x 0.6mm  
straight, smooth



PC 21-6365-07  
3.5 x 0.6mm  
straight, serrated



PC 21-6365-08  
4.0 x 0.6mm  
straight, smooth



PC 21-6365-09  
4.0 x 0.6mm  
straight, serrated



PC 21-6365-10  
3.0 x 0.6mm  
curved up, serrated

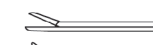

PC 21-6365-11  
3.0 x 0.6mm  
right, serrated



PC 21-6365-12  
3.0 x 0.6mm  
left, serrated



0.6mm



PC 21-6366-01  
3.5 x 0.5mm  
straight



PC 21-6366-C2  
3.5 x 0.5mm  
curved up



PC 21-6366-03  
3.5 x 0.5mm  
right



PC 21-6366-04  
3.5 x 0.5mm  
left

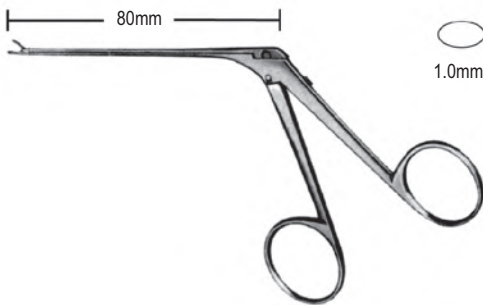

1.0mm



PC 21-6367-01  
4.0 x 0.9mm  
straight



PC 21-6367-02  
4.0 x 0.9mm  
curved up



PC 21-6367-03  
4.0 x 0.9mm  
right



PC 21-6367-04  
4.0 x 0.9mm  
left

- EN —● Micro Ear Scissors
- DE —● Mikro-Ohrscheren
- ES —● Micro-tijeras auriculares

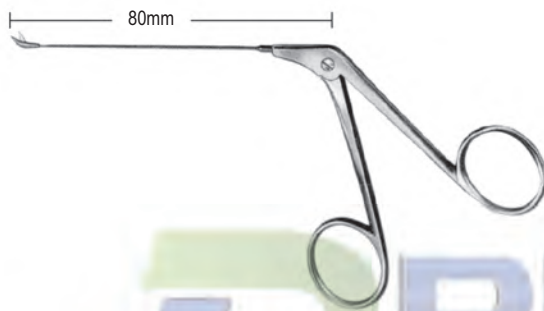

**WULLSTEIN**



PC 21-6378-01  
4.0 x 0.8mm  
straight



PC 21-6378-02  
4.0 x 0.8mm  
curved up



PC 21-6378-03  
4.0 x 0.8mm  
right

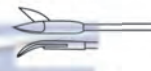

PC 21-6378-04  
4.0 x 0.8mm  
left

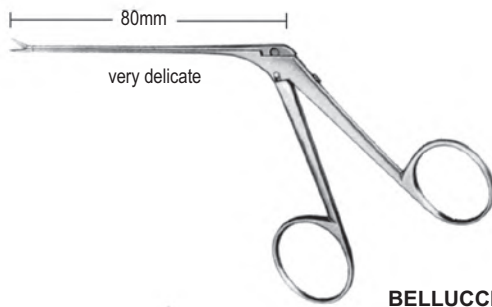

**BELLUCCI**

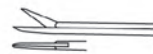

PC 21-6379-01  
4.0 x 1.5mm  
straight



PC 21-6379-02  
4.0 x 1.5mm  
curved up

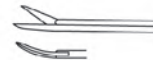

PC 21-6379-03  
4.0 x 1.5mm  
right



PC 21-6379-04  
4.0 x 1.5mm  
left



Micro Ear and Wire Closure Forceps ●— EN  
 Micro Ear and Wire Closure Zange ●— DE  
 Micro del oído y pinzas de alambre de cierre ●— ES



**Henckel**  
 crocodile, scoop blades  
 PC 21-6380-02

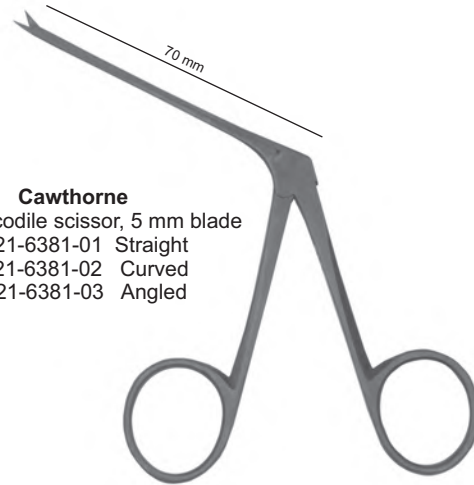

**Cawthorne**  
 micro crocodile scissor, 5 mm blade  
 PC 21-6381-01 Straight  
 PC 21-6381-02 Curved  
 PC 21-6381-03 Angled



**Hartmann**  
 crocodile, 7 mm serrated jaws  
 PC 21-6382-02



**Hartmann**  
 micro crocodile, 3 mm serrated jaws  
 PC 21-6383-02

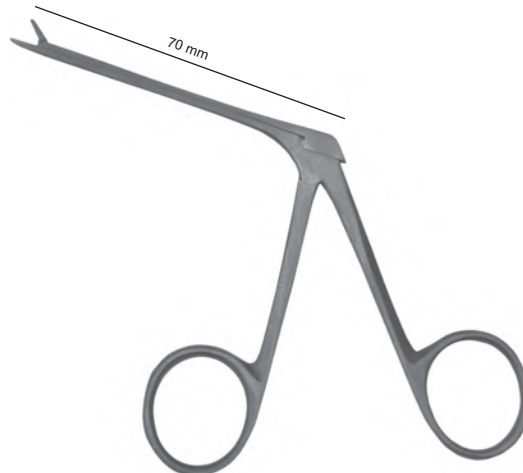

**Hough**  
 medium micro crocodile  
 5 mm serrated jaws  
 PC 21-6384-01 Straight  
 PC 21-6384-02 Angled

- EN —● Wire Closure Forceps
- DE —● Drahtbiegezaugchen
- ES —● Pinza para doblar alambre

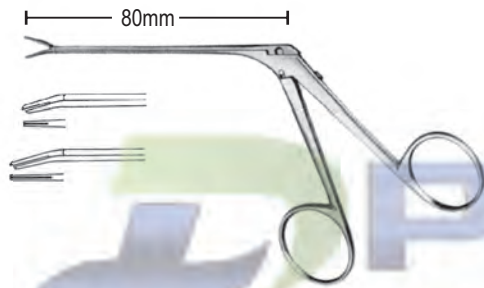

**McGEE**  
 PC 21-6385-01 0.8 X 3.5mm  
 PC 21-6385-02 0.8 X 6.0mm

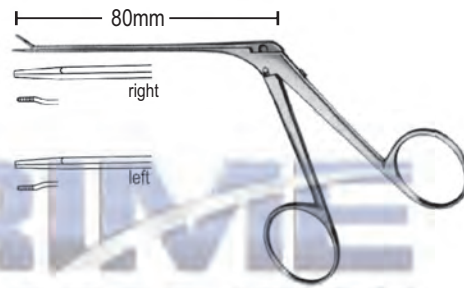

**JUERS**  
 PC 21-6386-01 right  
 PC 21-6386-02 left

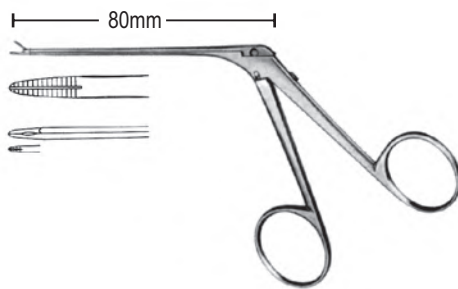

**GREVEN**  
 PC 21-6387-01

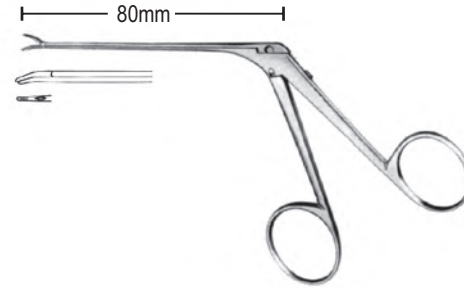

**SCHUKNECHT**  
 PC 21-6388-01

Introduction Instrument, Crura and Malleus Nippers ●— EN  
 Crurotomie-und Hammerkopfzangchen ●— DE  
 pinzas para la cruratomia y la cabeza del martillo ●— ES



**FULLER**  
PC 21-6389-01

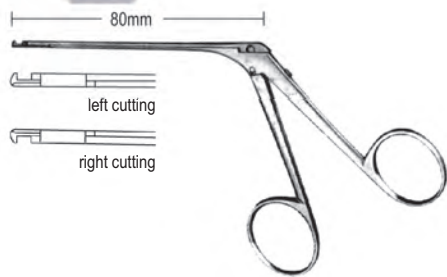

**HOUSE-DIETER**  
PC 21-6390-01 left cutting  
PC 21-6390-02 right cutting

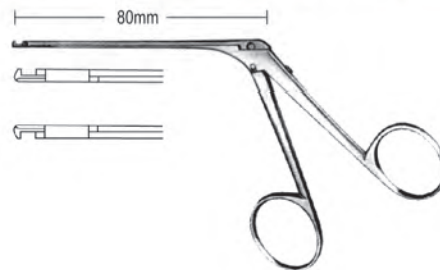

**HOUSE-DIETER**  
PC 21-6391-01 down cutting  
PC 21-6391-02 up cutting

EN —● Micro Surgery Instruments  
 DE —● Mikrochirurgische Instrumente für  
 ES —● Instrumentos Micro Cirugia



**Cawthorne Stape Hook (Black Finish)**  
 16.5cm / 6 1/2"  
 PC 21-6392-10 (set of 9)

Micro Surgery Instruments ●— EN  
 Mikrochirurgische Instrumente für ●— DE  
 Instrumentos Micro Cirugia ●— ES

Messer

Knives



**Schuknecht**  
PC 21-6393-01



**Schuknecht**  
PC 21-6394-02



**Schuknecht**  
PC 21-6395-01



**Wullstein**  
PC 21-6396-01



**Tabb**  
PC 21-6397-01



**Plester**  
PC 21-6398-01



**Plester**  
PC 21-6399-02



PC 21-6400-03



**Rosen**



PC 21-6401-10  
1.0 mm



PC 21-6402-14  
1.4 mm



PC 21-6403-16  
1.6 mm



PC 21-6404-20  
2.0 mm



PC 21-6405-26  
2.6 mm



PC 21-6406-28  
2.8 mm



PC 21-6407-30  
3.0 mm



- EN —● Micro Surgery Instruments
- DE —● Mikrochirurgische Instrumente für
- ES —● Instrumentos Micro Cirugia

Needles And Hooks

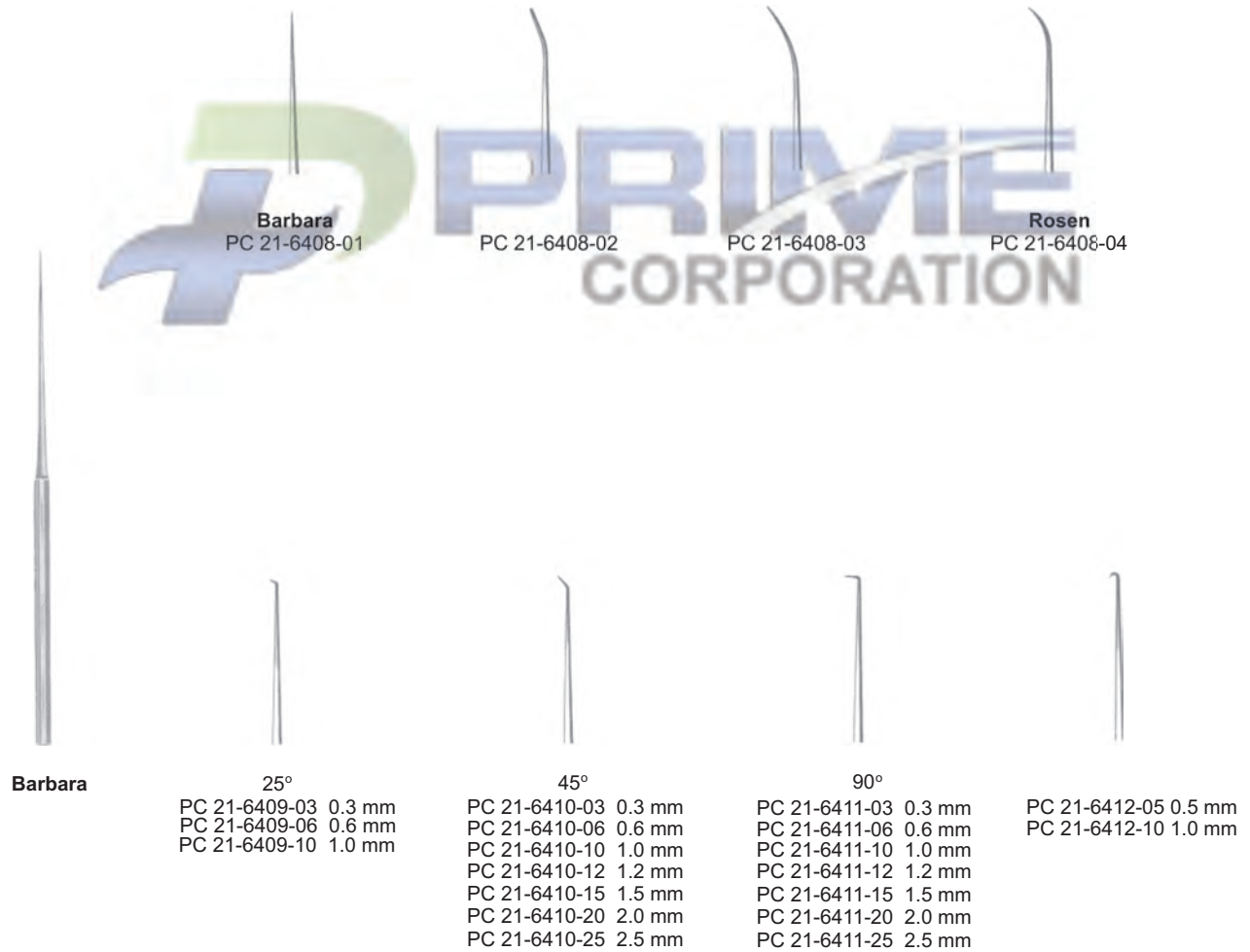

Micro Surgery Instruments ● EN  
 Mikrochirurgische Instrumente für ● DE  
 Instrumentos Micro Cirugia ● ES

Needles And Hooks

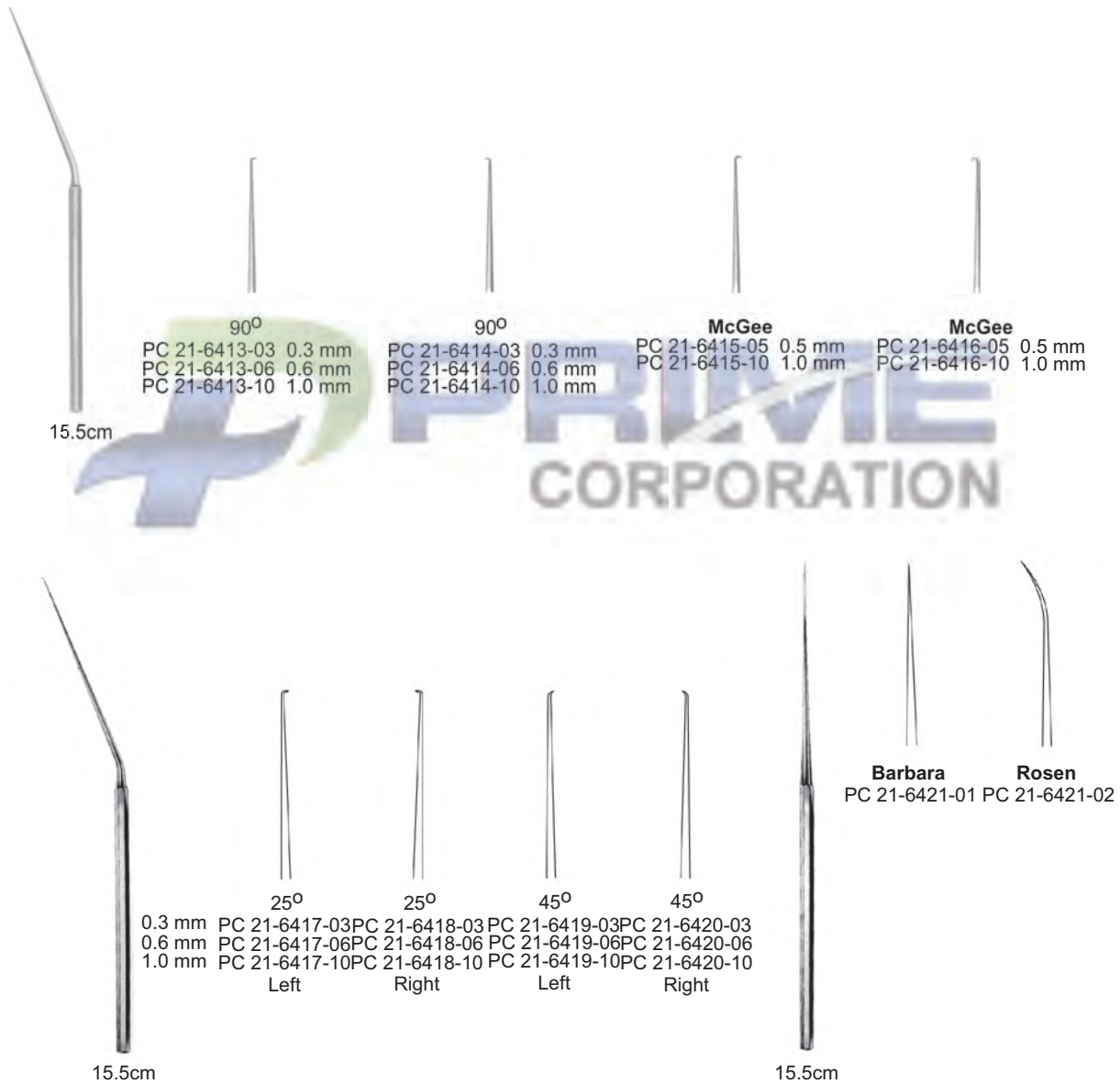

- EN —● Micro Surgery Instruments
- DE —● Mikrochirurgische Instrumente für
- ES —● Instrumentos Micro Cirugia

Dissectors, Measuring Road, Elevators, Curettes and Mobilizer

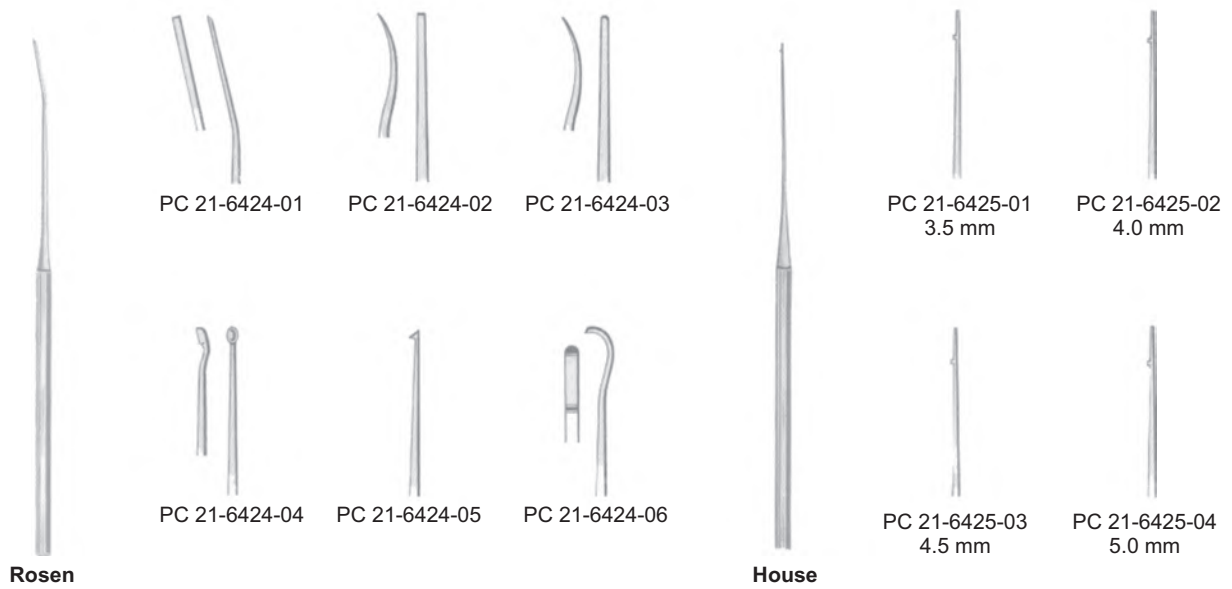

Micro Surgery Instruments ●— EN  
 Mikrochirurgische Instrumente für ●— DE  
 Instrumentos Micro Cirugia ●— ES

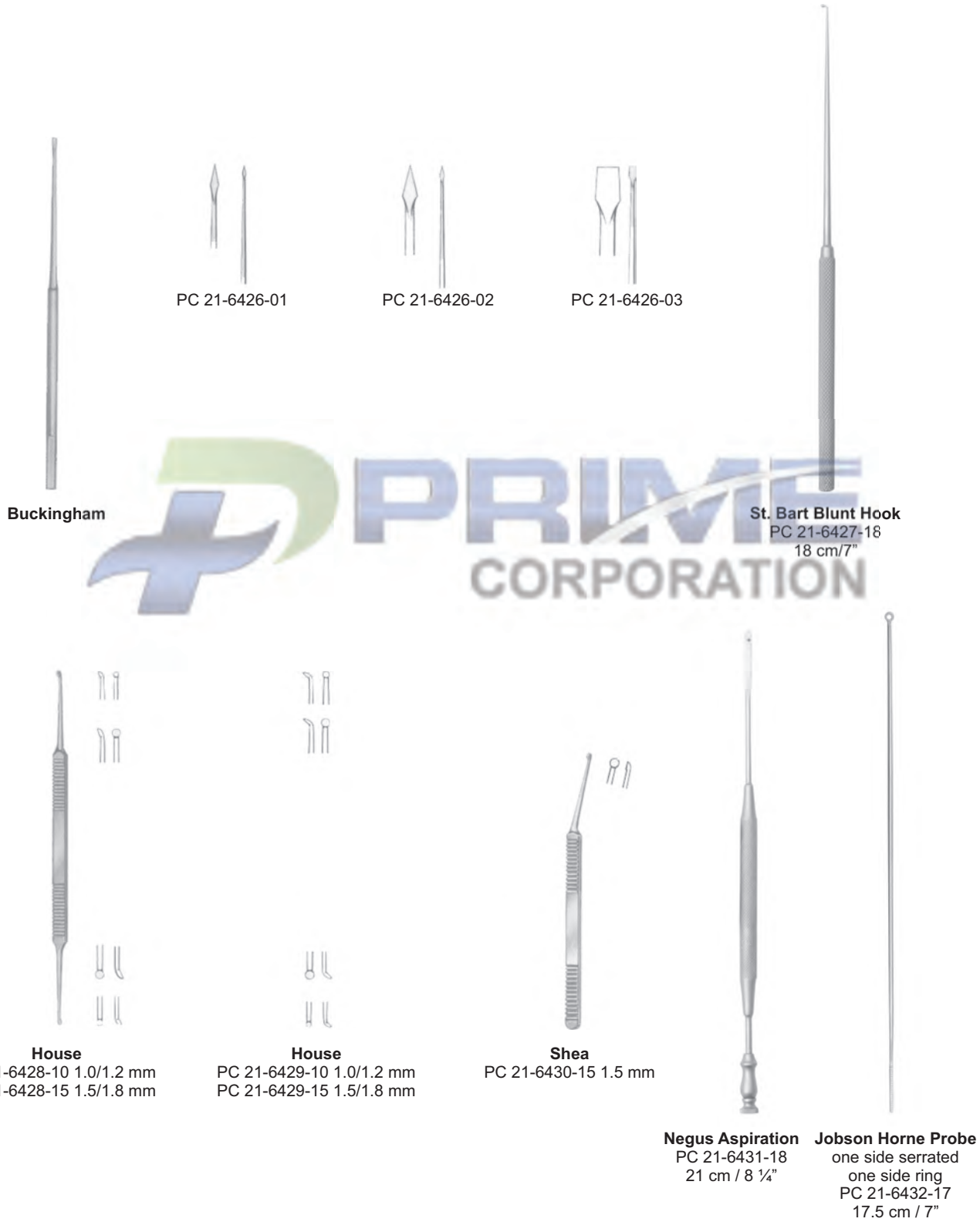

EN —● Currettes  
 DE —● Kurretten  
 ES —● Curetas

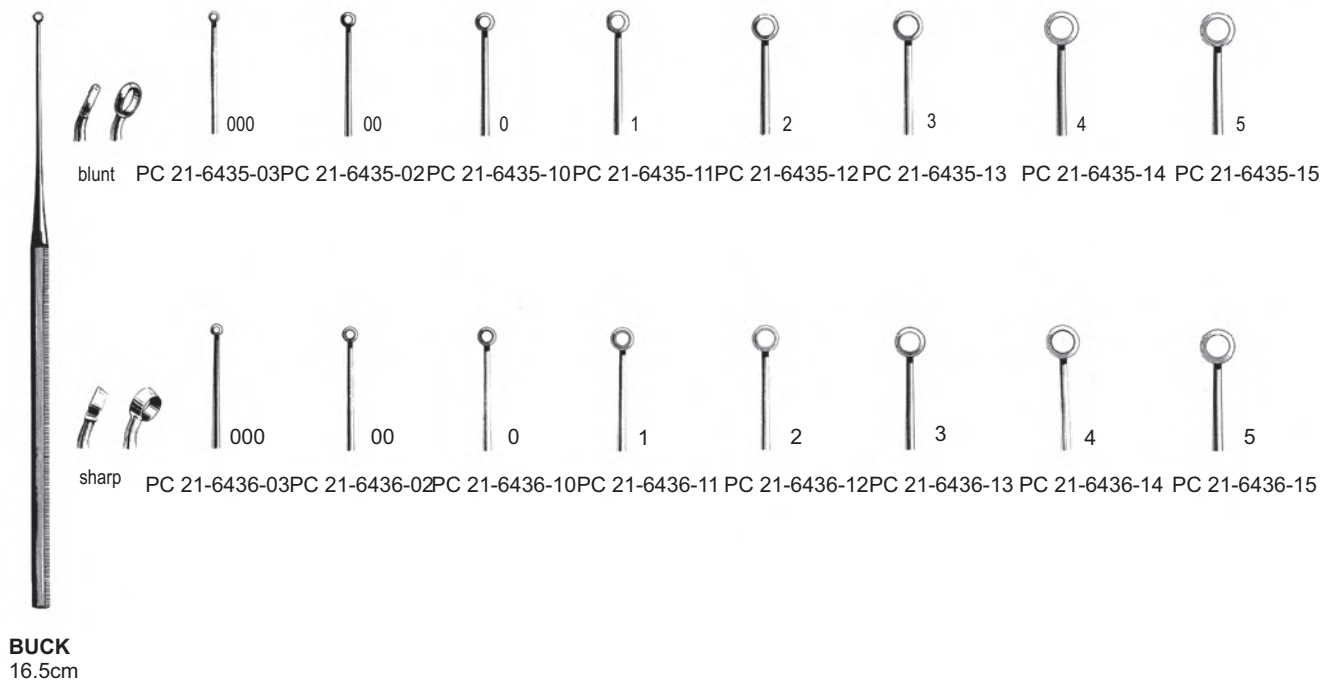
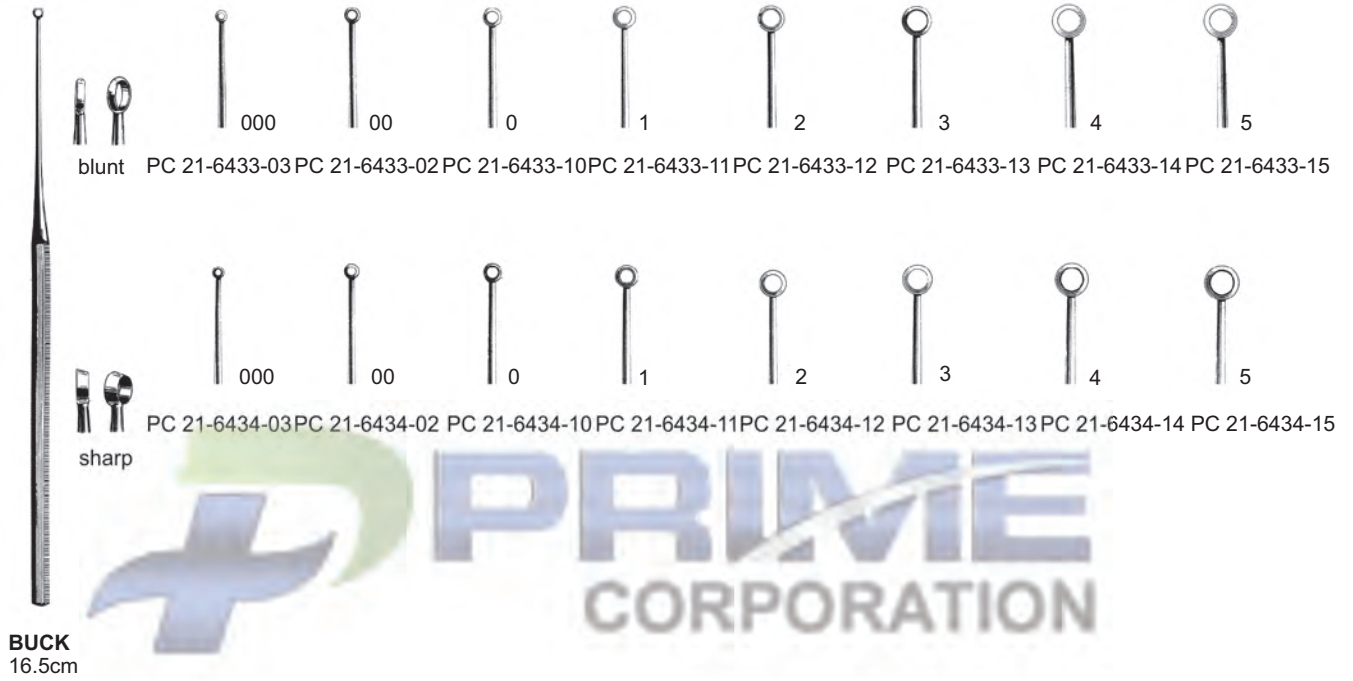



Micro Surgery Instruments ●— EN  
 Mikrochirurgische Instrumente für ●— DE  
 Instrumentos Micro Cirugia ●— ES



**Citelli**  
 Width of Bite PC 21-6437-20 2.0 mm  
 PC 21-6437-30 3.0 mm





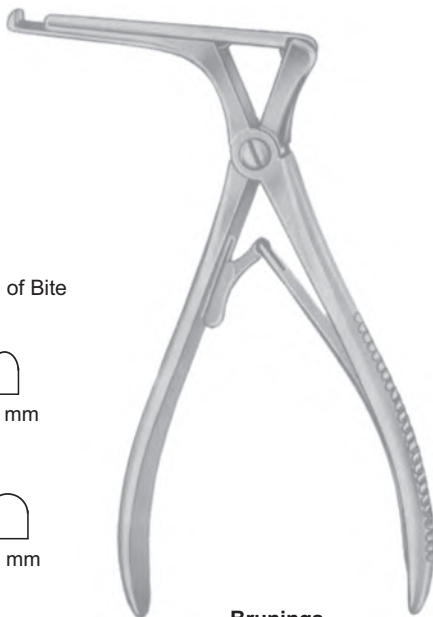

**Citelli-Beyer**  
 Width of Bite PC 21-6438-15 1.5 mm  
 PC 21-6438-20 2.0 mm



Width of Bite



**Brunings**  
 PC 21-6439-40  
 PC 21-6439-60

-  PC 21-6440-30 3.0 mm
-  PC 21-6440-40 4.0 mm
-  PC 21-6440-50 5.0 mm
-  PC 21-6440-60 6.0 mm



**Kerrison**  
 20 cm/8"

- EN —● Footplate Instruments acc. To Heermann
- DE —● Stapesplatten-Instrumente n. Heermann
- ES —● Instrumental estapediense de Heermann.



PC 21-6443-01 7.0cm    PC 21-6443-02 7.0cm    PC 21-6443-03 7.0cm    PC 21-6443-04 7.0cm    PC 21-6443-05 7.0cm    PC 21-6443-06 7.0cm    PC 21-6443-07 7.0cm

Elevators, Raspatories etc. ●— EN  
 Elevatorien, Raspatorien usw. ●— DE  
 Elevadores, periostotomos ●— ES



**LEMPERT**  
19.0cm



PC 21-6444-02  
2mm



PC 21-6445-02  
2mm



PC 21-6445-03  
3mm

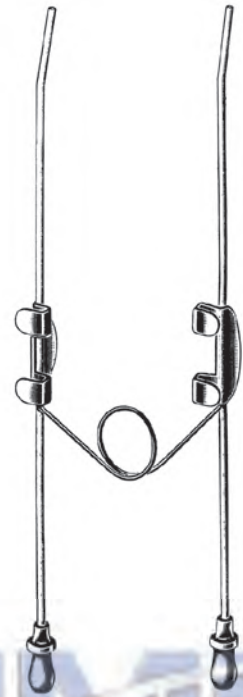

**SHAMBAUGH**

PC 21-6446-19 19.5cm left tube 2.0mm Ø  
 PC 21-6447-19 19.5cm right tube 2.0mm Ø  
 PC 21-6448-18 18.0cm left tube 2.5mm Ø  
 PC 21-6449-20 20.5cm right tube 2.5mm Ø



**LEMPERT**  
PC 21-6448-18  
18.0cm



**LEMPERT**  
PC 21-6449-20  
20.5cm

- EN —● Currettes and Spoons
- DE —● Kurretten, Loffel
- ES —● Curetas y cucharillas



**LANGENBECK**  
PC 21-6450-13  
13.0cm



**SHAPLEIGH**  
13.0cm



PC 21-6451-01



PC 21-6451-02



PC 21-6451-03



PC 21-6451-04



**COXETER**  
PC 21-6452-15  
15.0cm  
blunt



PC 21-6453-17 17.0cm blunt  
PC 21-6453-18 17.0cm sharp



**JANSEN**  
PC 21-6454-15  
15.0cm  
sharp



**BARTH**  
PC 21-6455-18  
18.0cm  
sharp

Loops, Foreign Body Instruments, Hooks ●— EN  
 Schlingen, Fremdkörperinstrumente, Haken ●— DE  
 Asas, instrumentos para cuerpos extraños, ganchos ●— ES

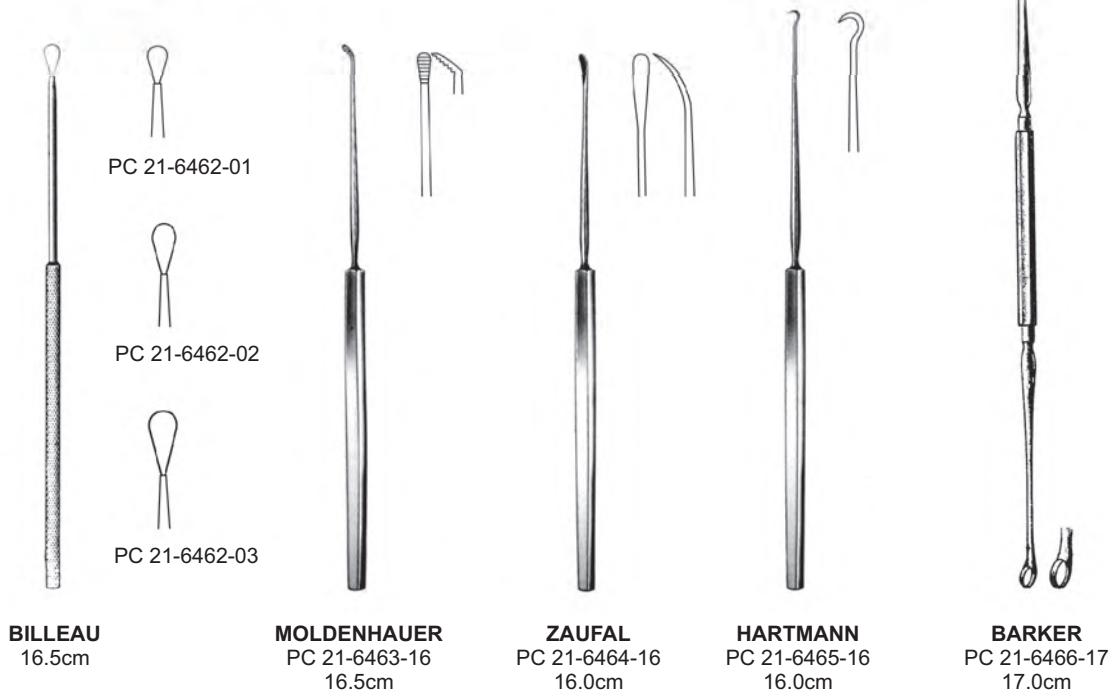



- EN —● Hooklets
- DE —● Hakchen
- ES —● Ganchitos

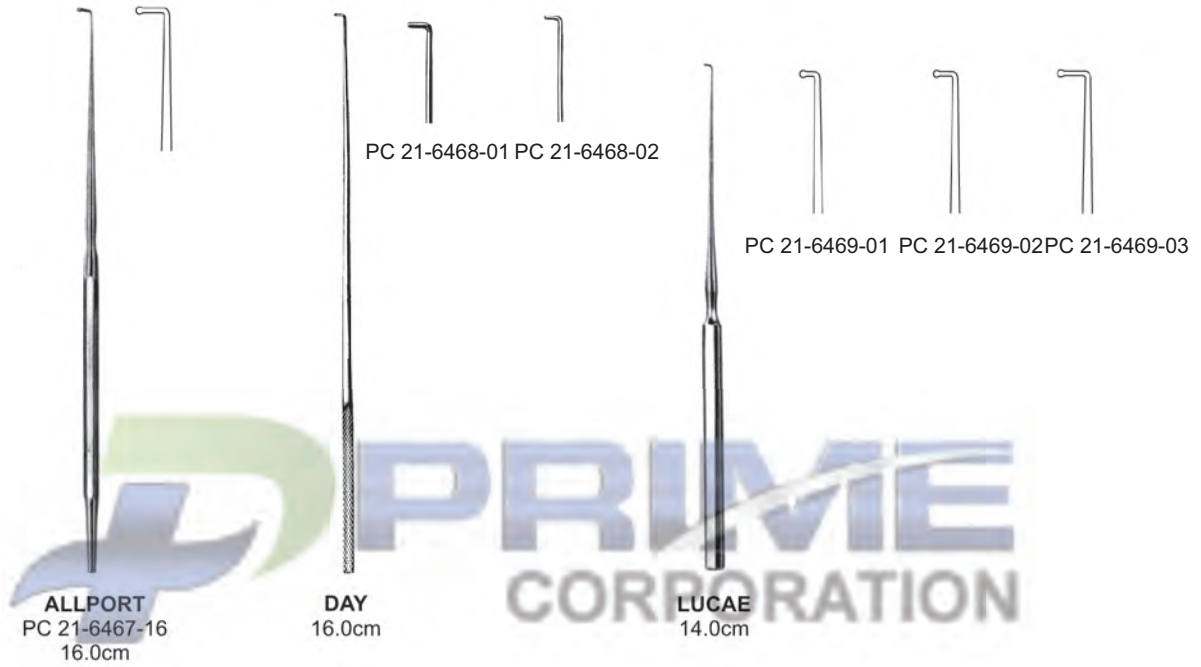

Paracentesis Needles ●— EN  
 Parazentesenadeln ●— DE  
 Aguja para paracentesis ●— ES

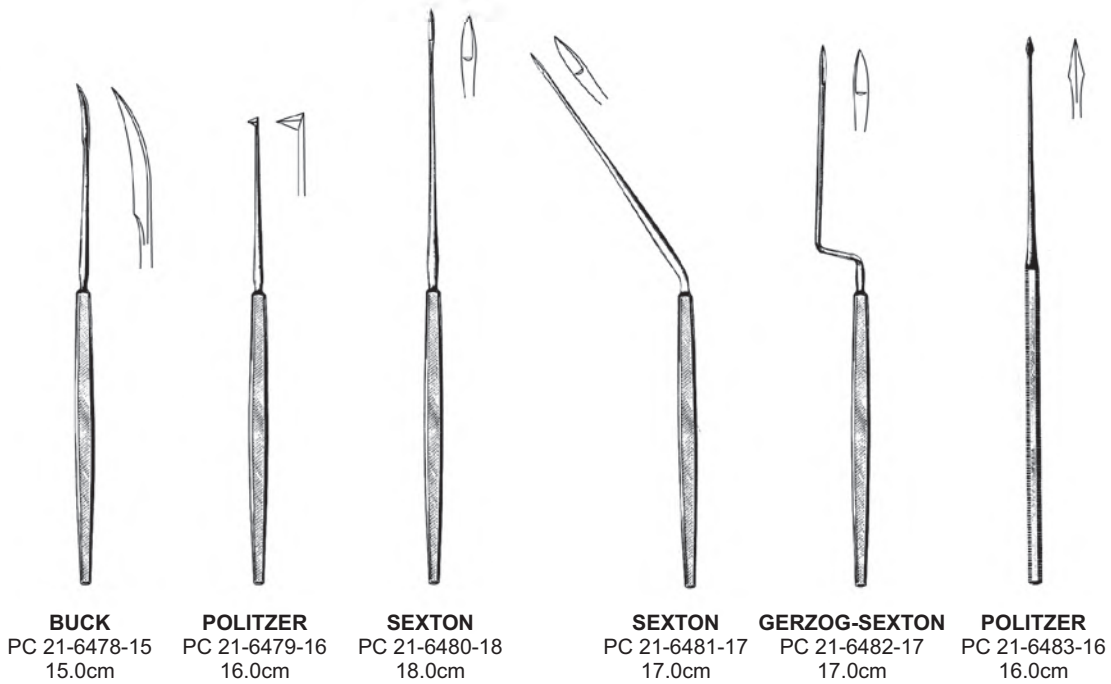
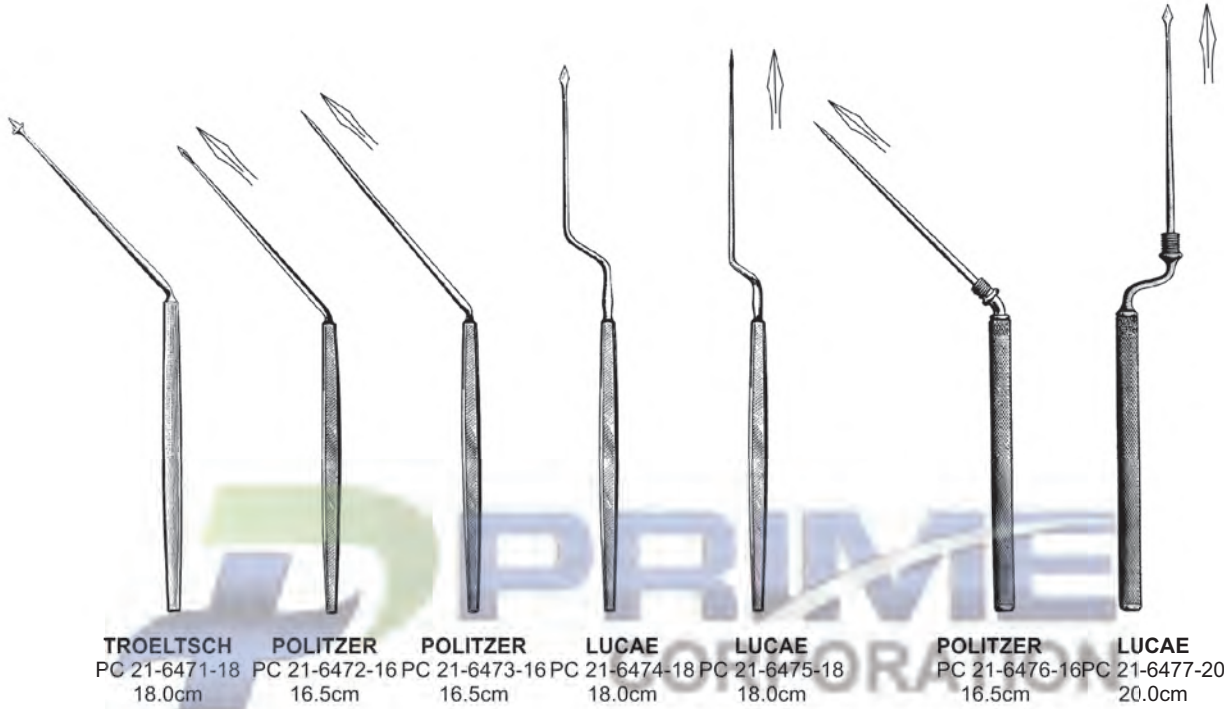

- EN —● Tuning Fork Sets
- DE —● Stimmgabelbestecke
- ES —● Juegos de diapasones



**HARTMANN-OSTMANN**  
PC 21-6484.00  
set of 8 tuning forks

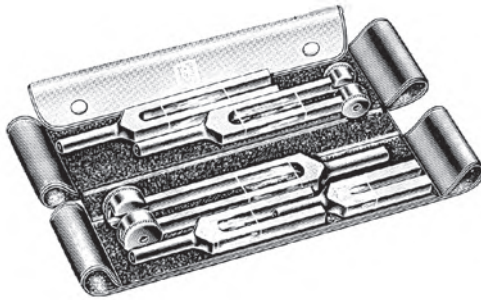

PC 21-6485-00  
set of 5 alloy tuning forks



**HARTMANN**  
PC 21-6486-00      PC 21-6487-00  
set of 5 tuning forks      set of 6 tuning forks

**EN** Rhinology

**DE** Rhinologie

**ES** Rinología

**Page 541 to 574**



- EN —● Nasal Speculas
- DE —● Nasenspekula
- ES —● Espéculos nasales

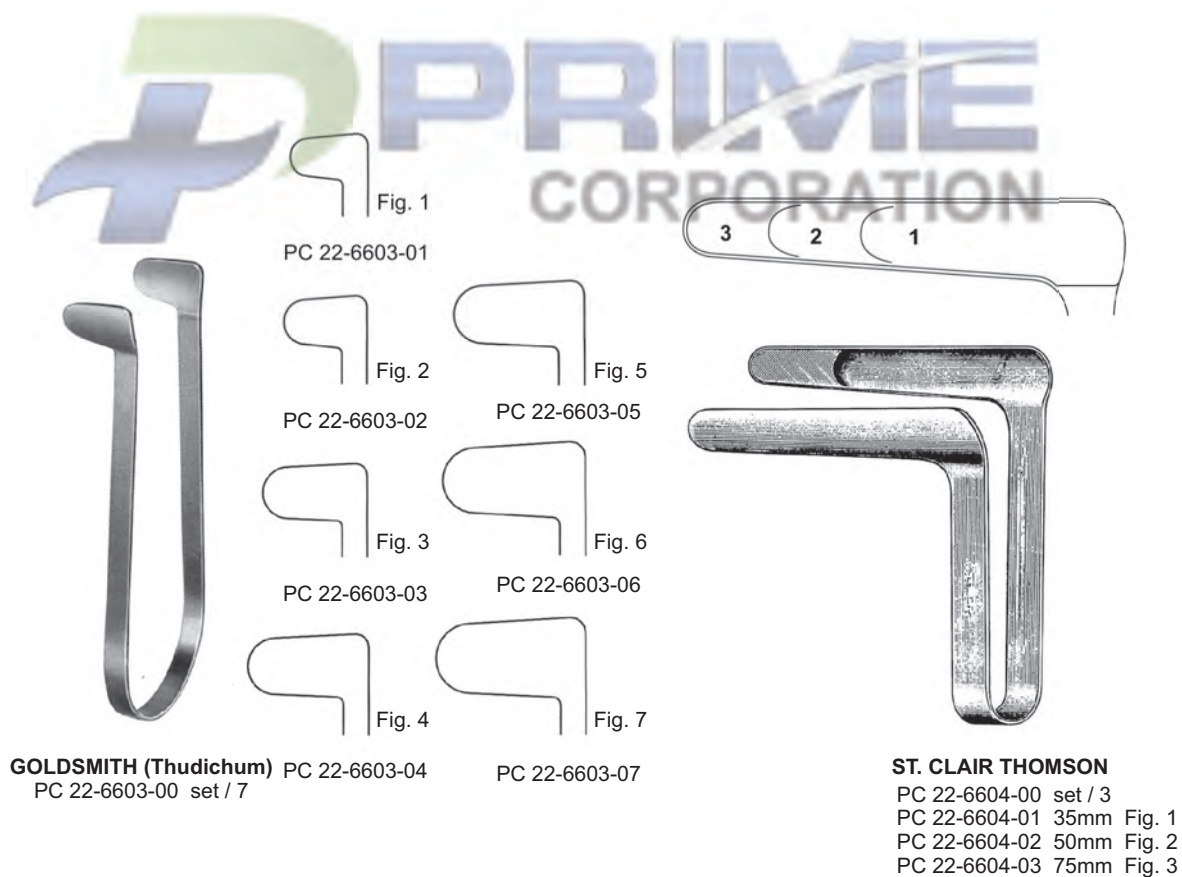
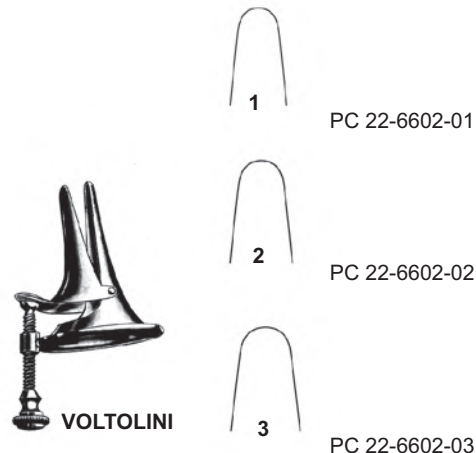



Nasal Speculas ●— EN  
 Nasenspekula ●— DE  
 Espéculos nasales ●— ES



**HARTMANN-HALLE**  
 15.0cm  
 PC 22-6605-01 Fig. 1  
 PC 22-6605-02 Fig. 2  
 PC 22-6605-03 Fig. 3

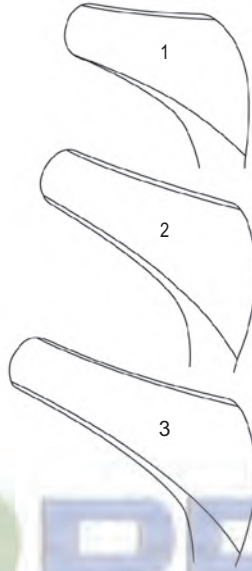

**SCHWARZ**  
 PC 22-6606-14  
 14.0cm



**VIENNA**  
 14.5cm  
 PC 22-6607-01 (infant)  
 PC 22-6607-02 (child)  
 PC 22-6607-03 (adult)  
 PC 22-6607-04 (sheet metal)



**MOD WIEN**  
 PC 22-6608-14  
 14.5cm

- EN —● Nasal Speculas
- DE —● Nasenspekula
- ES —● Espéculos nasales



PC 22-6609-13  
13.0cm

PC 22-6610-13  
13.0cm

**TIECK-HALLE**  
13.5cm  
PC 22-6611-01  
PC 22-6611-02

**TIECK-HALLE**  
PC 22-6612-13  
13.5cm

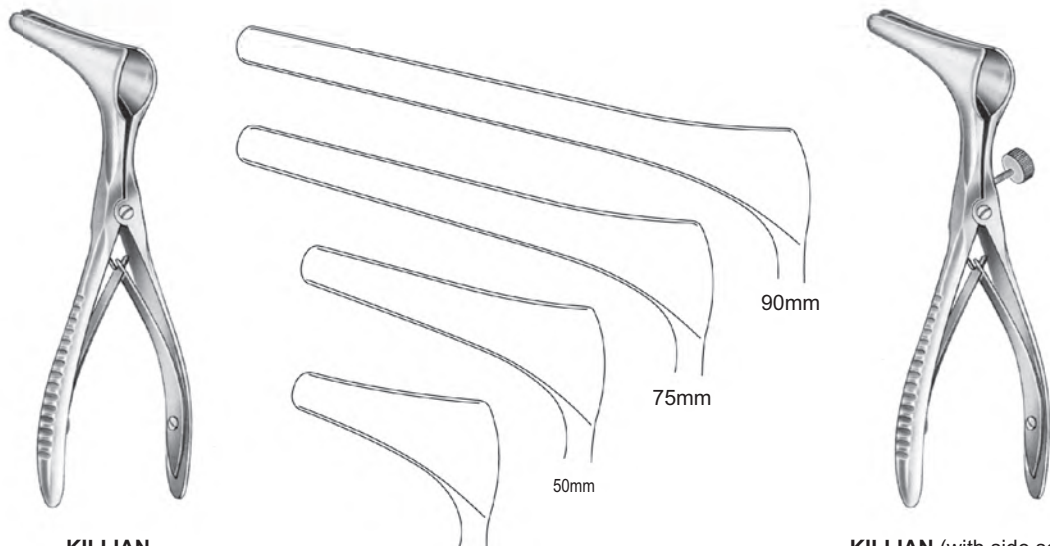

**KILLIAN**  
13.0cm  
PC 22-6613-35  
PC 22-6613-50  
PC 22-6613-75  
PC 22-6613-90

**KILLIAN (with side screw)**  
13.0cm  
PC 22-6614-35  
PC 22-6614-50  
PC 22-6614-75  
PC 22-6614-90

Nasal Speculas ●— EN  
 Nasenspekula ●— DE  
 Espéculos nasales ●— ES

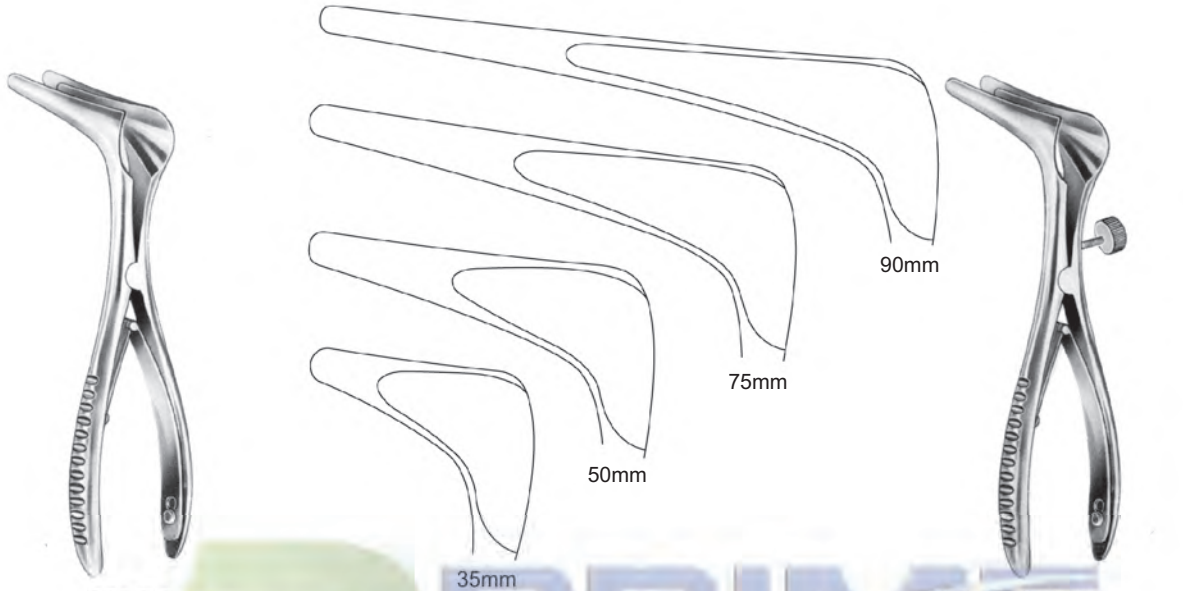

**COTTLE**  
 15.0cm  
 PC 22-6615-35  
 PC 22-6615-50  
 PC 22-6615-75  
 PC 22-6615-90

**COTTLE (with side screw)**  
 15.0cm  
 PC 22-6616-35  
 PC 22-6616-50  
 PC 22-6616-75  
 PC 22-6616-90

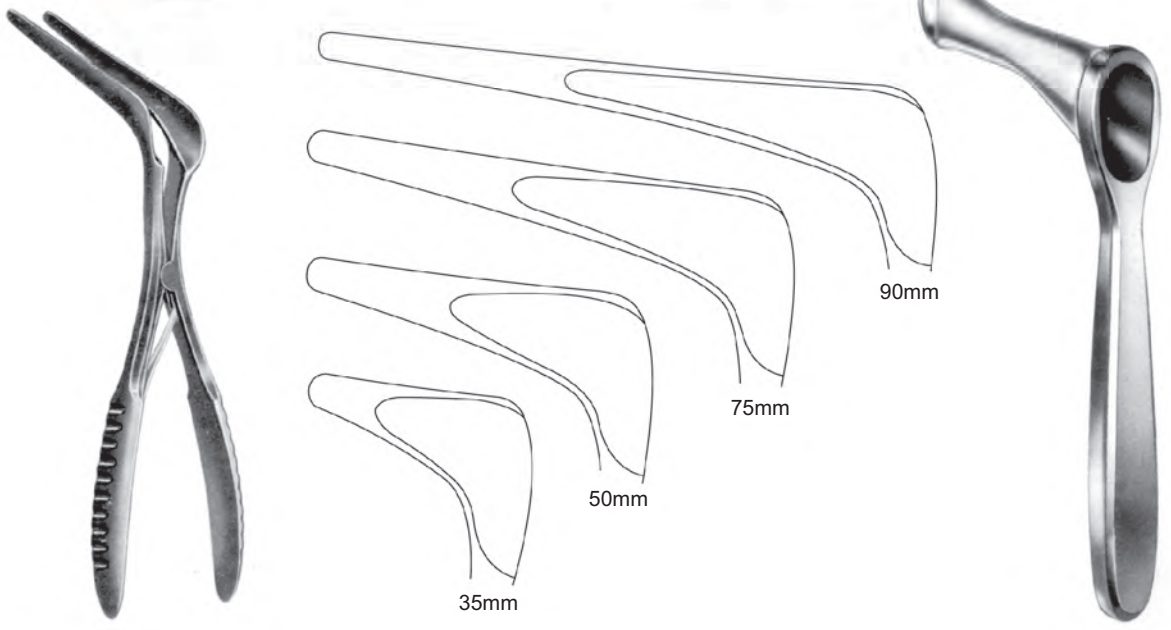

**COTTLE**  
 (dull black chromium plated)  
 14.0cm

PC 22-6617-35  
 PC 22-6617-50  
 PC 22-6617-75  
 PC 22-6617-90

**YANKAUER**  
 PC 22-6618-19  
 19.0cm

- EN —● Nasal Snares
- DE —● Polypenschnurer
- ES —● Polipotomos



PC 22-6619-03 0.3mm Ø  
PC 22-6619-04 0.4mm Ø



PC 22-6620-02 0.2mm Ø  
PC 22-6620-03 0.3mm Ø



**KRAUSE**  
PC 22-6621-26  
26.0cm

**KRAUSE-VOSS**  
PC 22-6622-26  
26.0cm

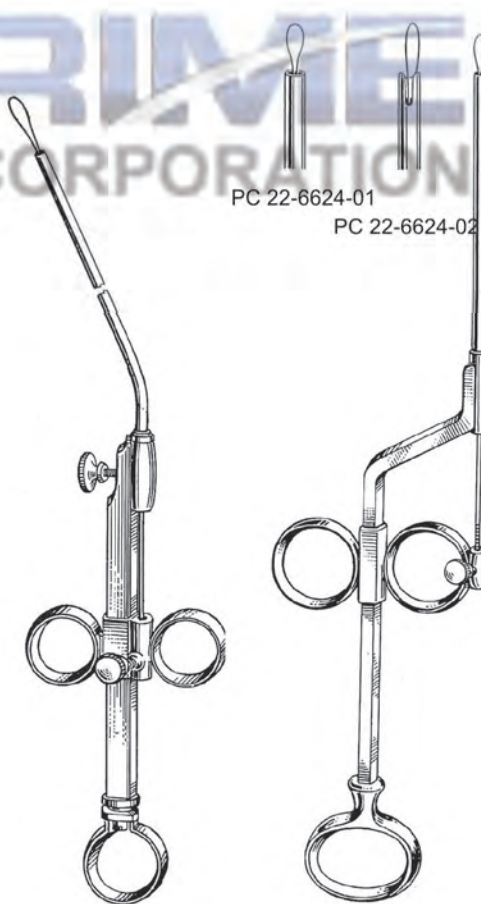

**KRAUSE**  
PC 22-6623-00

PC 22-6624-01  
PC 22-6624-02

**GLEGG**



Nasal Polypus and Septum Compression Forceps ●— EN  
 Polypenzangen, Septumzange ●— DE  
 Pinzas para polipos, pinzas para el tabique nasal ●— ES

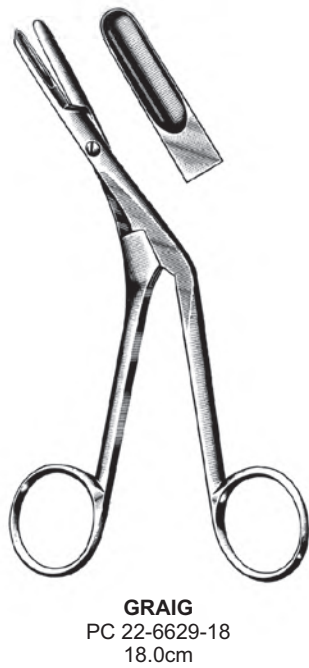



- EN —● Nasal Polypus and Septum Compression Forceps
- DE —● Polypenzangen, Septumzange
- ES —● Pinzas para polipos, pinzas para el tabique nasal

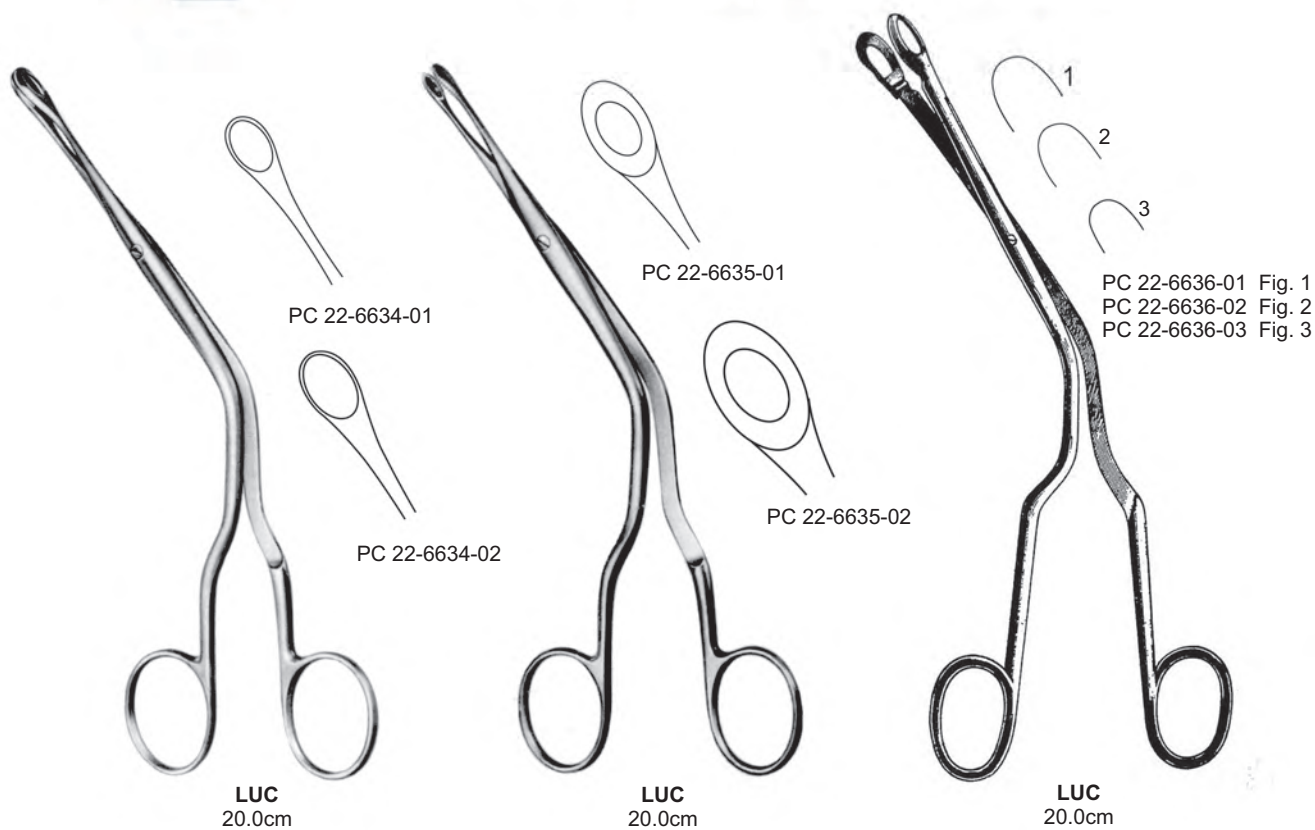

Dressing and Tampon Forceps ●— EN  
 Tamponpinzetten und-zangen ●— DE  
 Pinzas para compresas y taponamientos ●— ES

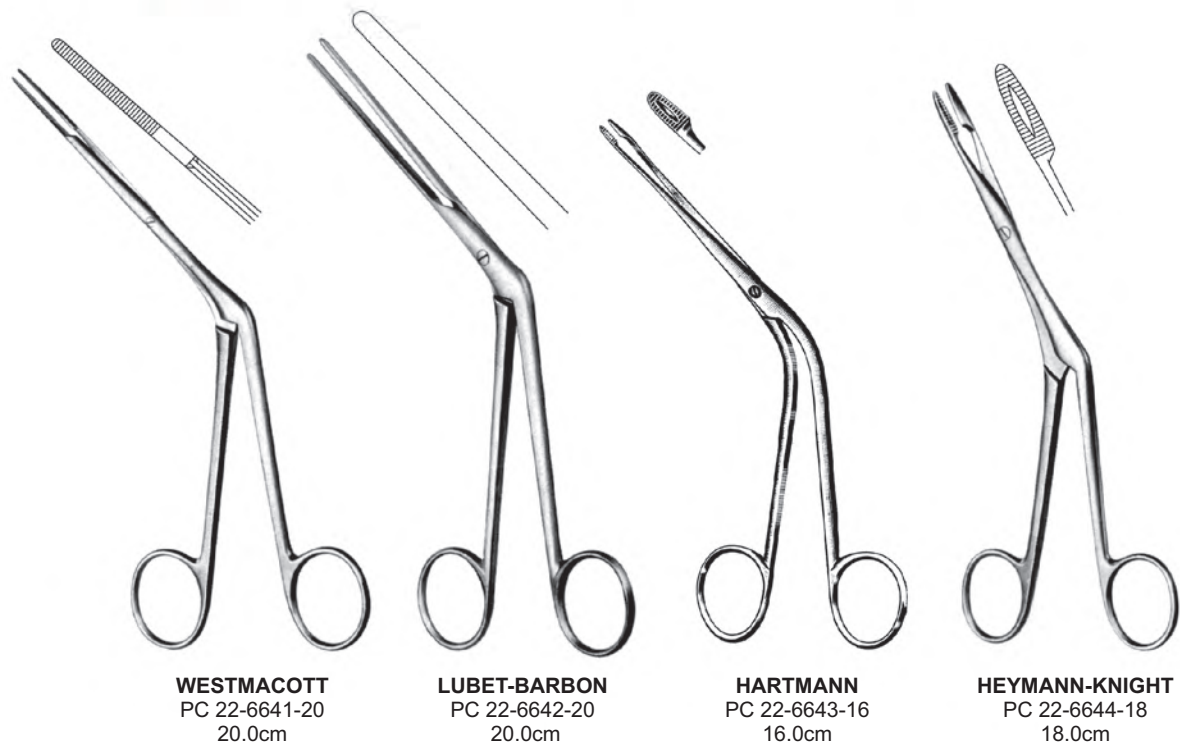

- EN —● Nasal Cutting Forceps
- DE —● Scharfe Nasenzangen
- ES —● Pinzas cortantes cara la nariz



**HENCKEL**  
PC 22-6645-20  
20.0cm

**JATHO**  
PC 22-6646-15

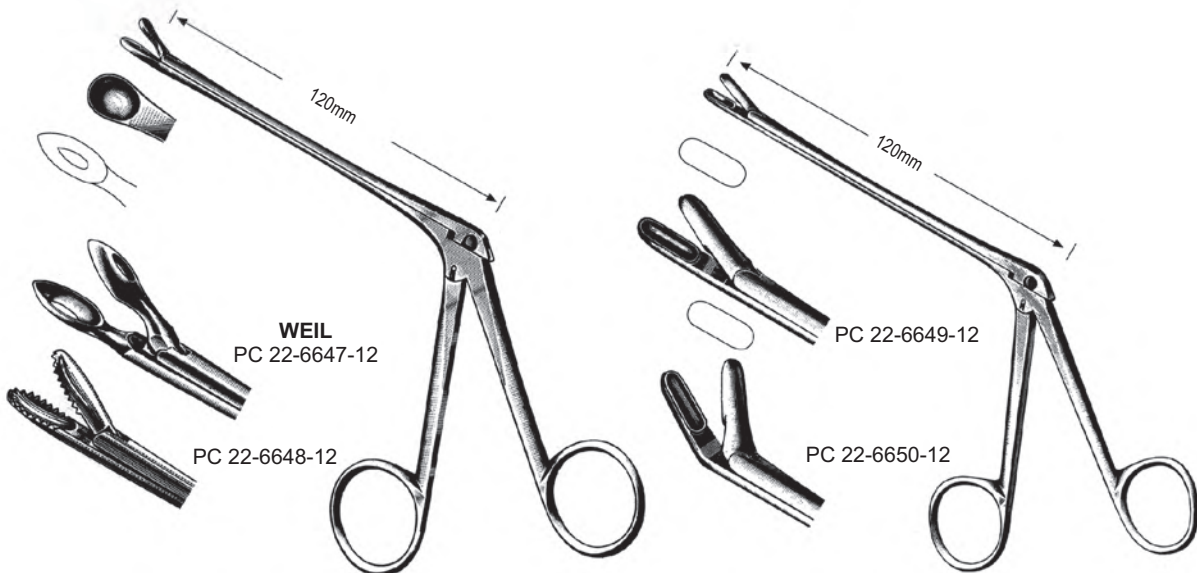

**WEIL**  
PC 22-6647-12

PC 22-6648-12

PC 22-6649-12

PC 22-6650-12

**WATSON-WILLIAMS**  
PC 22-6648-19  
19.0cm

**TAKAHASHI**  
19.0cm

Nasal Cutting Forceps ●— EN  
 Scharfe Nasenzangen ●— DE  
 Pinzas cortantes cara la nariz ●— ES

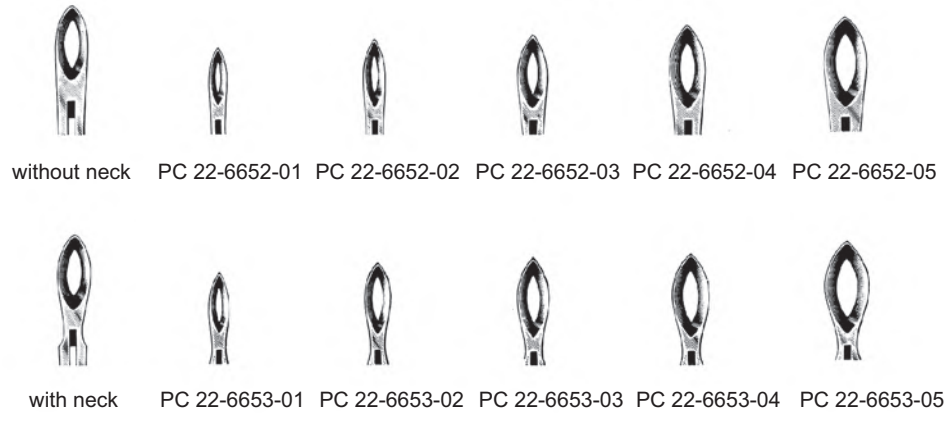
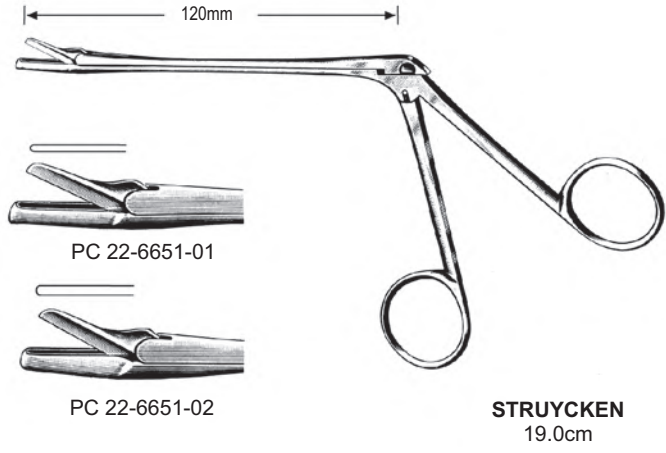



- EN —● Nasal Cutting Forceps
- DE —● Scharfe Nasenzangen
- ES —● Pinzas cortantes cara la nariz

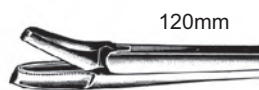
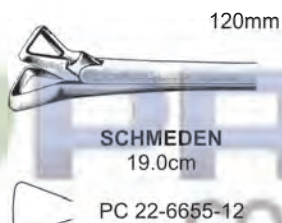
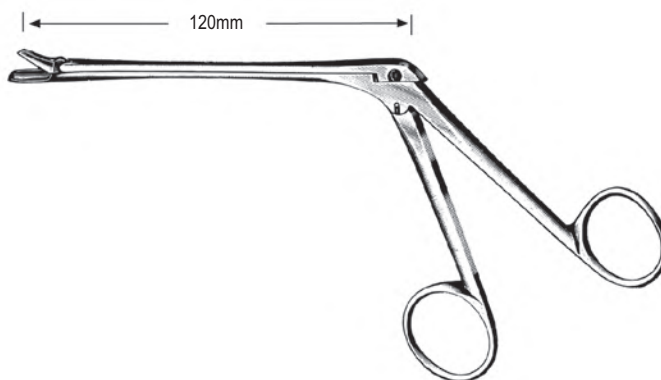

- PC 22-6657-01 2.2mm
- PC 22-6657-03 3mm



- PC 22-6657-02 2.6mm
- PC 22-6657-04 3.4mm

- PC 22-6658-01
- PC 22-6658-02
- PC 22-6658-03



Sphenoid Punches and Rongeur Forceps ● EN  
 Keibeinstanzen, Meibelzangen ● DE  
 Pinzas cortantes para seno esfesoidal, pinzas-gubias ● ES

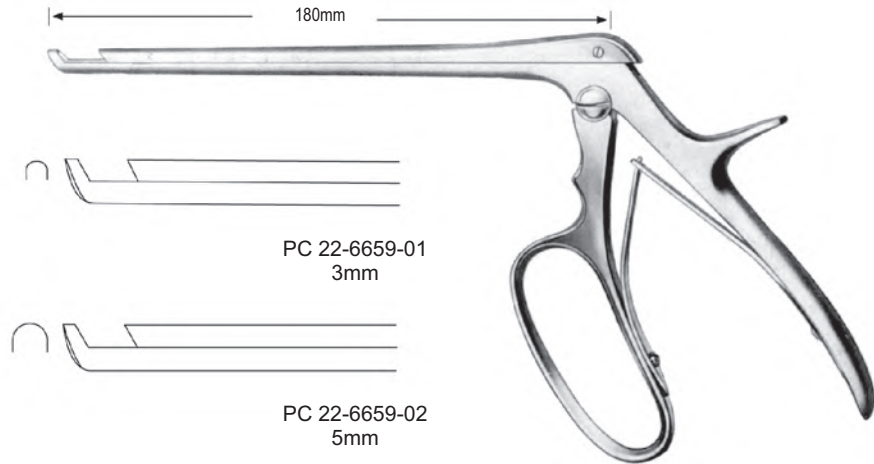

**FERRIS-SMITH-KERRISON  
(CLOWARD HARPER)**

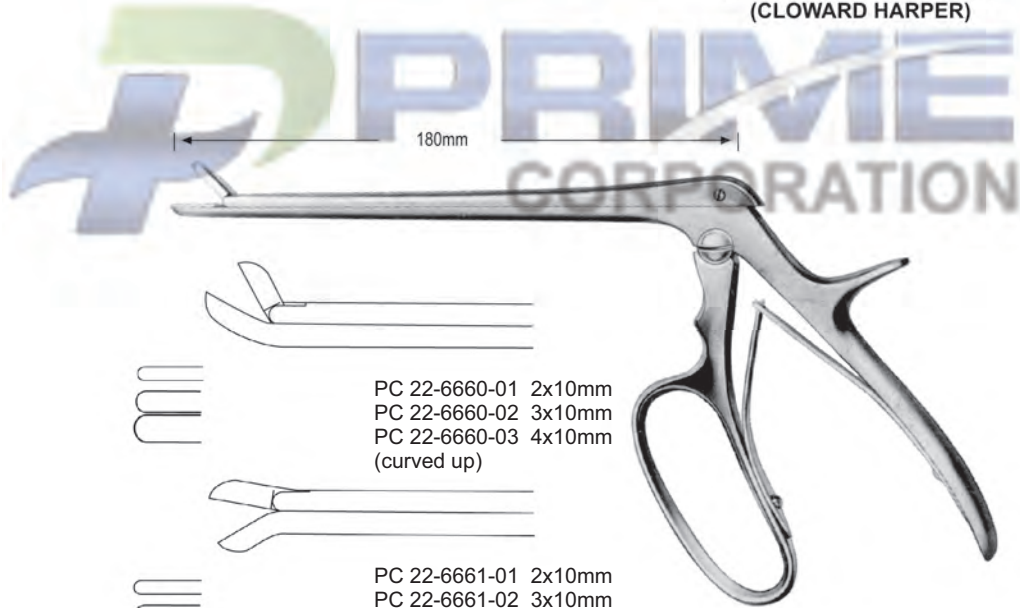

**FERRIS-SMITH-CUSHING**

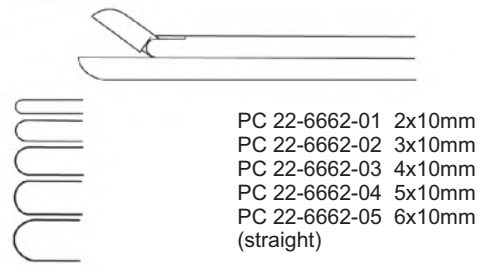

- EN —● Sphenoid Punches and Rongeur Forceps
- DE —● Keibeinstanzen, Meibelzangen
- ES —● Pinzas cortantes para seno esfesoidal, pinzas-gubias

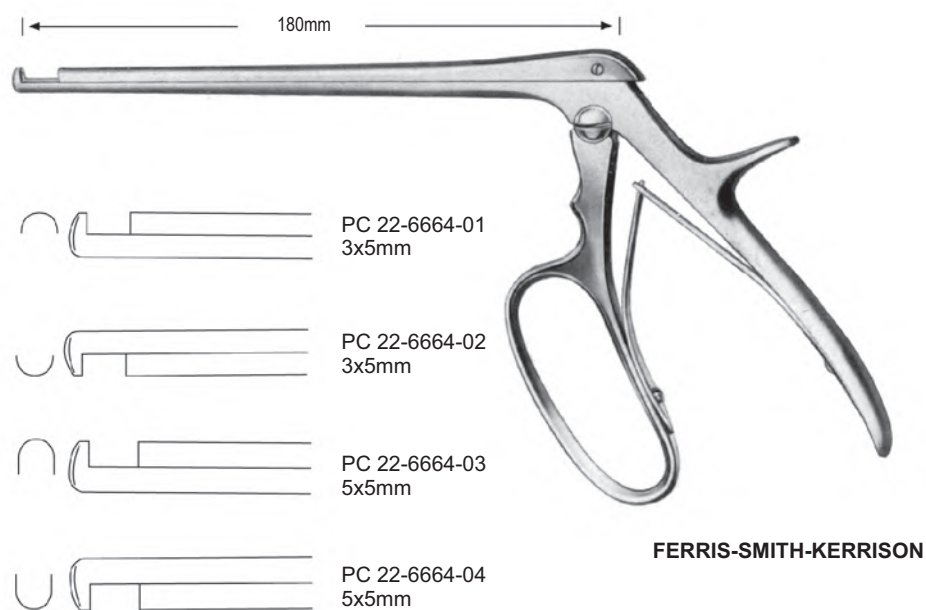
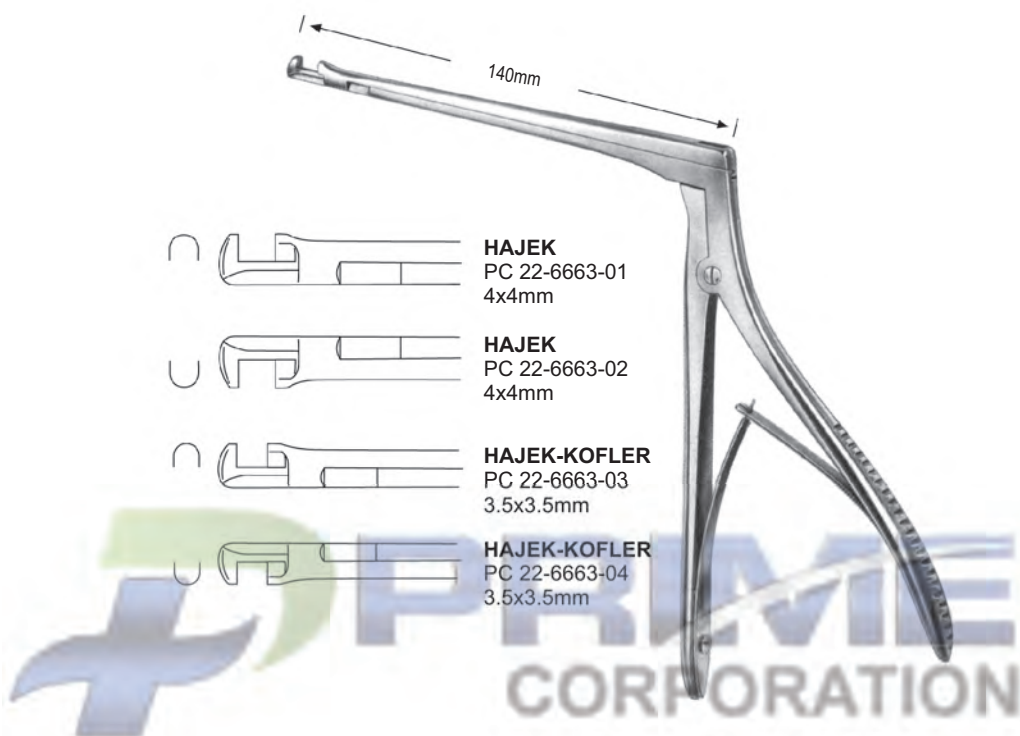

Sphenoid Punches and Rongeur Forceps ●— EN  
 Keibeinstanzen, Meibelzangen ●— DE  
 Pinzas cortantes para seno esfesoidal, pinzas-gubias ●— ES



- EN —● Septum Compression Forceps, Septum Scissors  
 DE —● Septumzangen, Septumscheren  
 ES —● Pinzas para el tabique nasal, tijeres para el tabique nasal

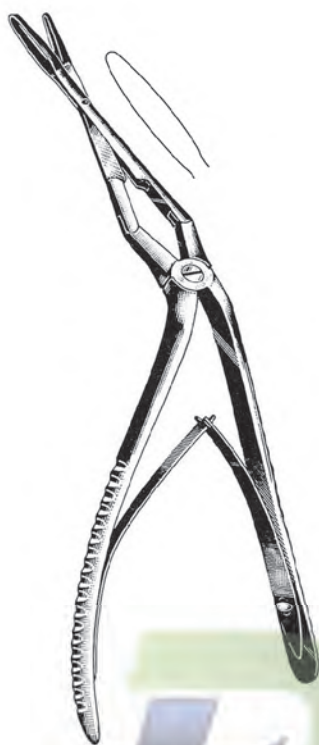

**JANSEN-STRUYCKEN**  
PC 22-6670-19  
19.0cm



**MIDDLETON-JANSEN**  
PC 22-6671-19  
19.0cm



**MIDDLETON-JANSEN**  
PC 22-6672-19  
19.0cm



**CAPLAN**  
PC 22-6673-20  
20.0cm



**KILLIAN**  
PC 22-6674-21  
21.0cm



**RUBIN**  
PC 22-6675-21  
21.0cm



Rhinoplastic and Nasal Knives ●— EN  
 Nasenplastik-und Operationsmesser ●— DE  
 Bisturías para plástica y operaciones de la nariz ●— ES

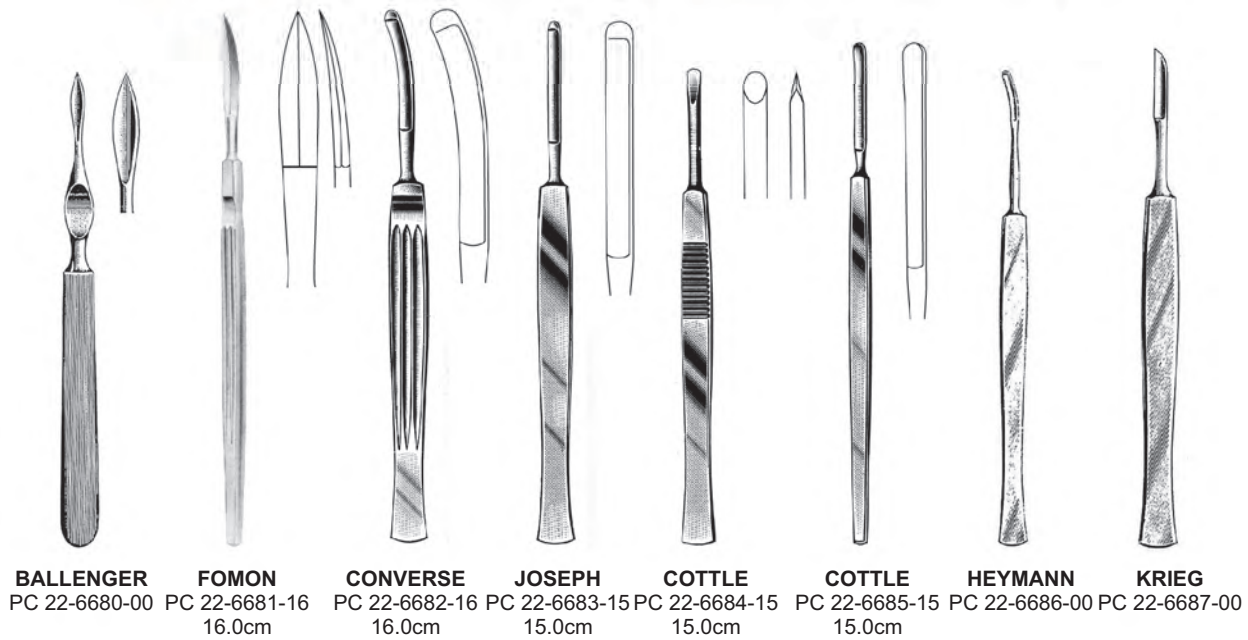
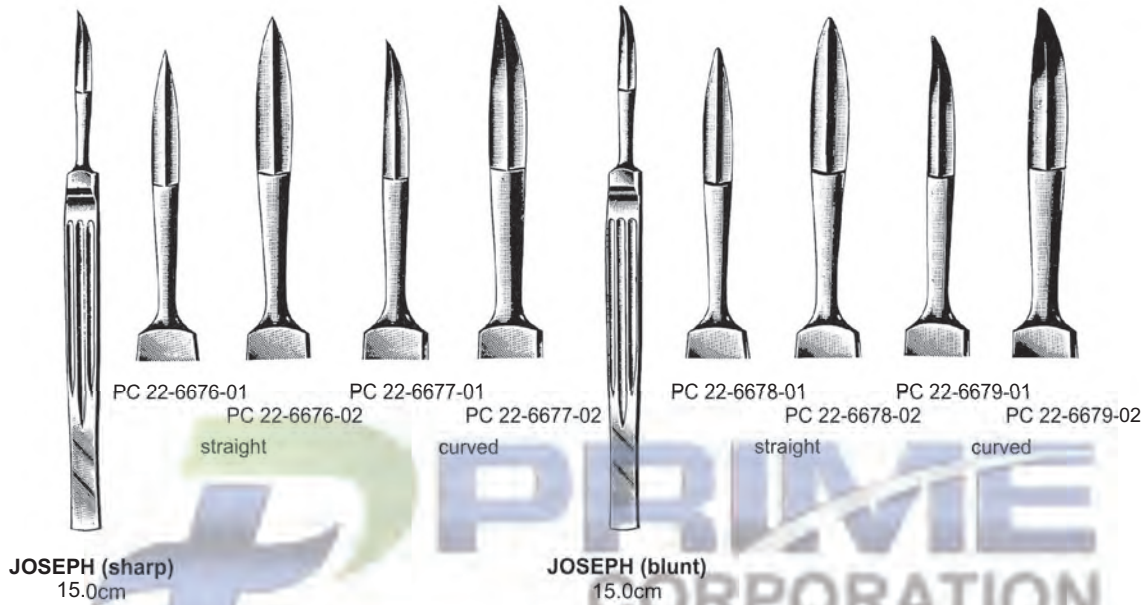



- EN —● Septum Knife, Mucous Knives, Swivel Knives
- DE —● Septummesser, Mukosamesser, Schwingmesser
- ES —● Cuchillo para el tabique nasal, la mucosa

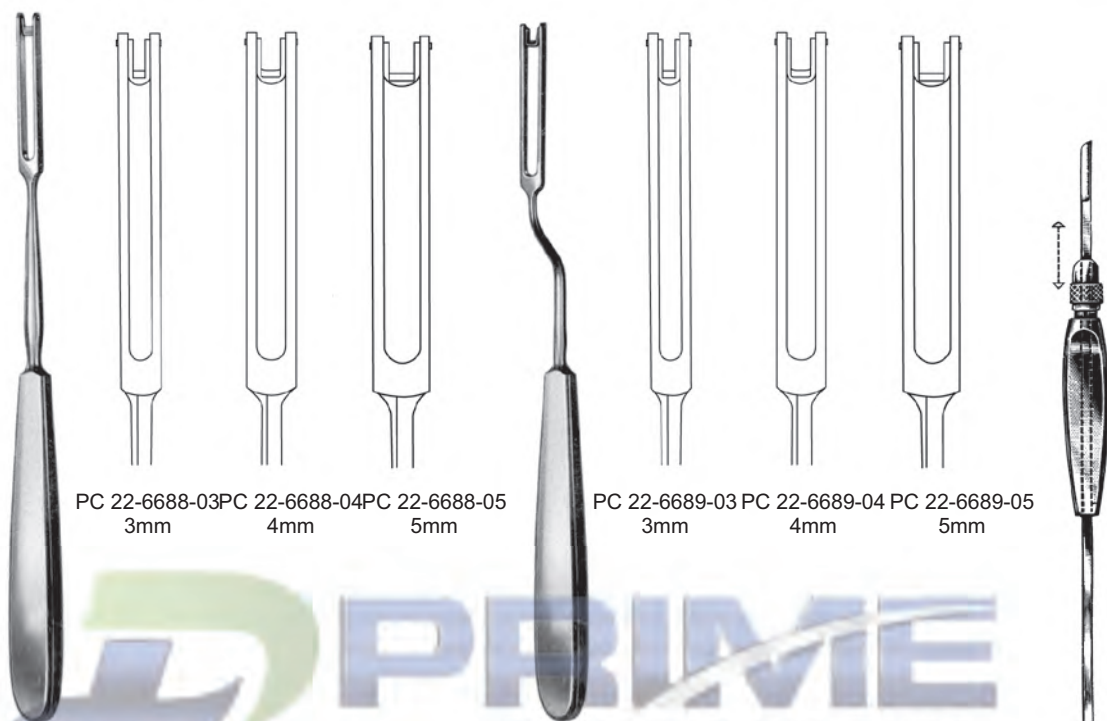

PC 22-6688-03 3mm  
PC 22-6688-04 4mm  
PC 22-6688-05 5mm

PC 22-6689-03 3mm  
PC 22-6689-04 4mm  
PC 22-6689-05 5mm

**BALLENGER**  
20.0cm

**BALLENGER**  
20.0cm

**BRUENINGS**  
PC 22-6690-16  
16.5cm



**FREER**  
PC 22-6691-00

**FREER**  
PC 22-6692-15  
15.0cm

**FREER**  
PC 22-6693-19  
19.0cm

**FREER**  
PC 22-6694-19  
19.0cm

**FREER**  
PC 22-6695-19  
19.0cm

**FREER**  
PC 22-6696-19  
19.0cm

Septum Elevators and Raspatories ●— EN  
 Septum-Elevatorien und Raspatorien ●— DE  
 Elecadores para el tabique nasal y lagras ●— ES

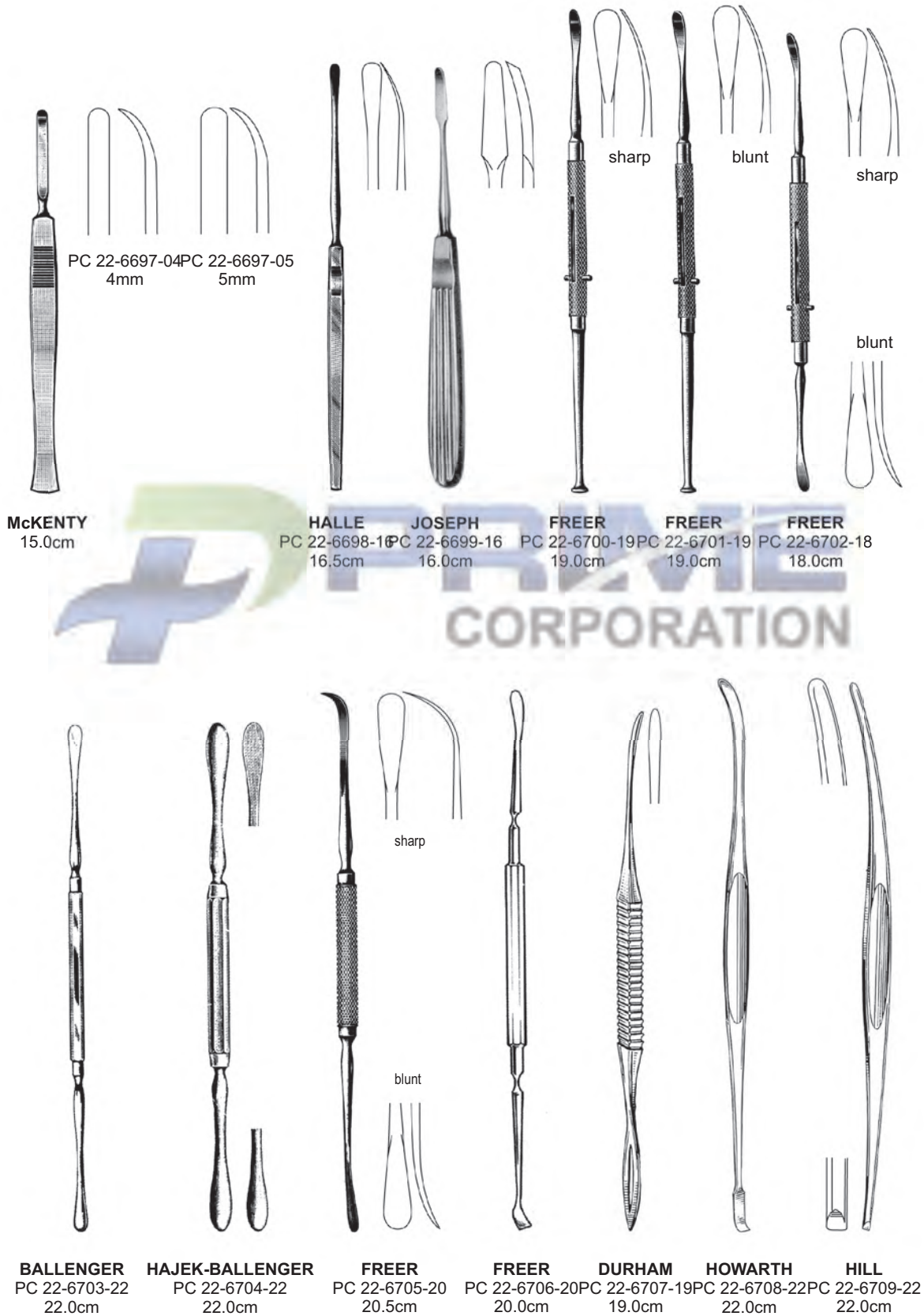

- EN —● Septum and Periosteal Elevators  
 DE —● Septum-und Periost-Elevatoren  
 ES —● Elevadores para el tabique nasal y para el periostia



<b>KILLIAN</b>	<b>KILLIAN</b>	<b>PIERCE</b>	<b>PENNINGTON</b>	<b>ROGER</b>	<b>McKENTY</b>	<b>COTTLE</b>
PC 22-6710-18	PC 22-6711-22	PC 22-6712-21	PC 22-6713-21	PC 22-6714-19	PC 22-6715-22	PC 22-6716-23
18.0cm	22.0cm	21.0cm	21.0cm	19.0cm	22.0cm	23.0cm

Septum and Periosteal Elevators ●— EN  
 Septum-und Periost-Elevatorien ●— DE  
 Elevadores para el tabique nasal y para el periostia ●— ES



<b>MASING</b> PC 22-6717-21 21.0cm	<b>CARTER</b> PC 22-6718-21 21.0cm	<b>COTTLE</b> PC 22-6719-21 21.0cm	<b>COTTLE</b> PC 22-6720-22 22.0cm	<b>JOSEPH</b> PC 22-6721-16 16.0cm	<b>COTTLE</b> PC 22-6722-19 19.0cm	<b>JOSEPH-MASING</b> PC 22-6723-22 22.0cm
--	--	--	--	--	--	---

- EN —● Septum Gouges, Chisels
- DE —● Septum-Hohlmeißel, -Meißel
- ES —● Gubias y cinceles para tabique nasal



**KILLIAN**  
PC 22-6724-17  
17.0cm



**KILLIAN-CLAUS**  
PC 22-6725-17  
17.0cm

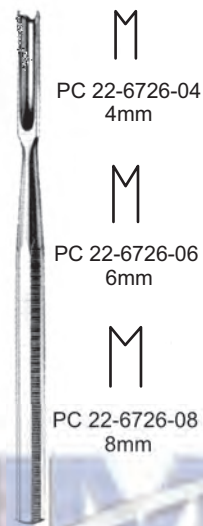

**BALLENGER**

PC 22-6726-04  
4mm

PC 22-6726-06  
6mm

PC 22-6726-08  
8mm



**FREER**  
PC 22-6727-15  
15.0cm



**WEST**  
PC 22-6728-16  
16.0cm



**WEST**  
PC 22-6729-16  
16.0cm



**FREER**  
PC 22-6730-16



**FREER**  
PC 22-6731-16

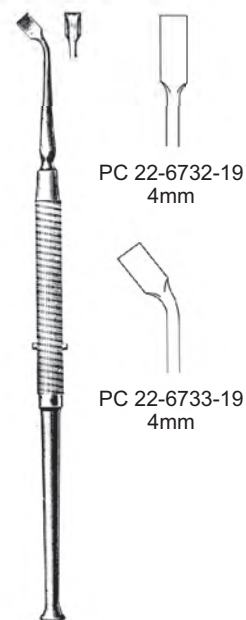

**FREER**

PC 22-6732-19  
4mm

PC 22-6733-19  
4mm



Nasal Saws, Chisels, Osteotomes ●— EN  
Nasel Sägen, Nasenmeißel, Osteotome ●— DE  
Sierras nasales, cinceles nasales, osteótomos ●— ES



- EN —● Osteotomes, Gouges, Chisels
- DE —● Osteotome, Hohlmeißel, Meißel
- ES —● Osteótomos, gubias, cinceles

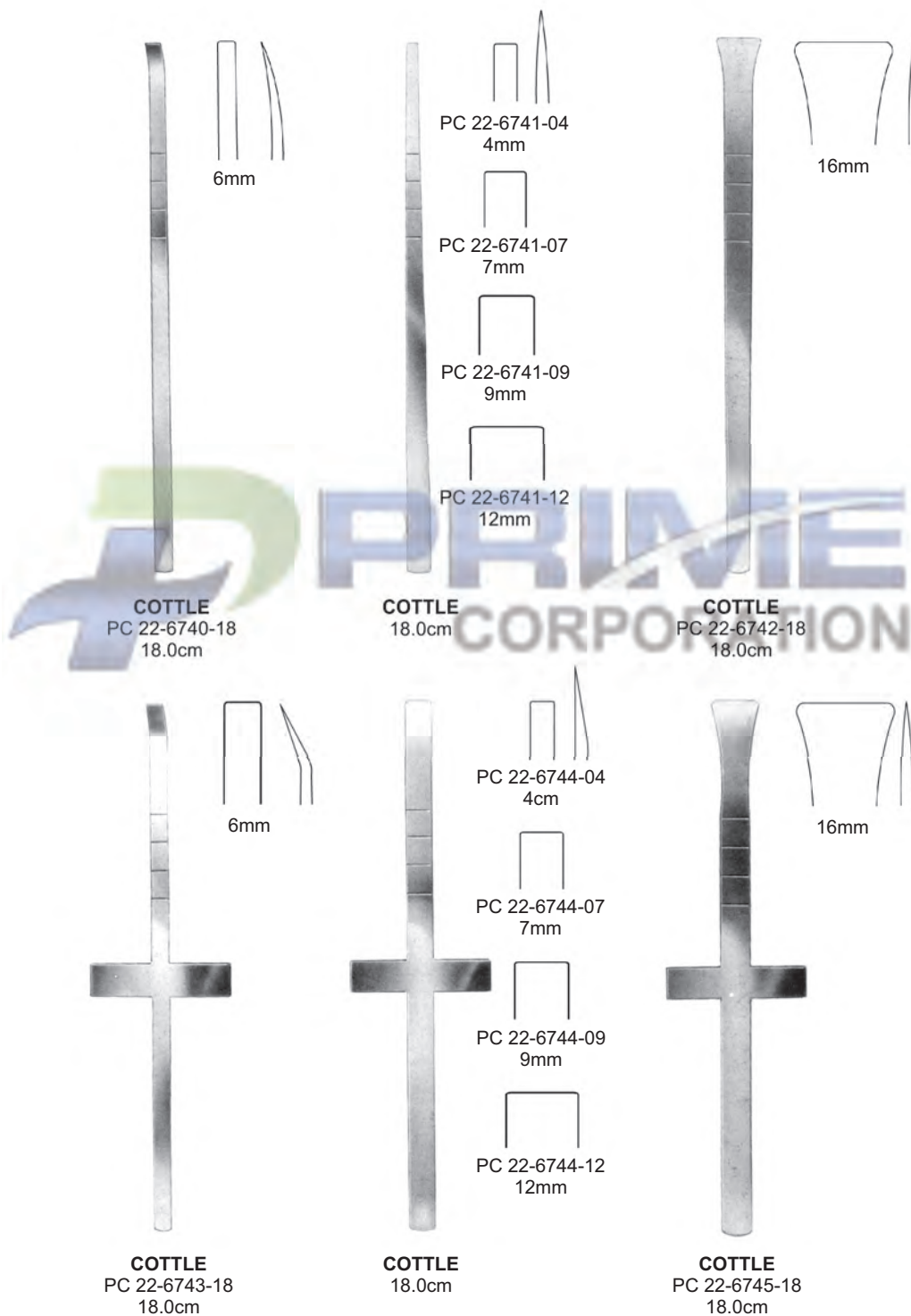

Osteotomes, Gouges, Chisels ●— EN  
 Osteotome, Hohlmeißel, Meißel ●— DE  
 Osteótomos, gubias, cinceles ●— ES

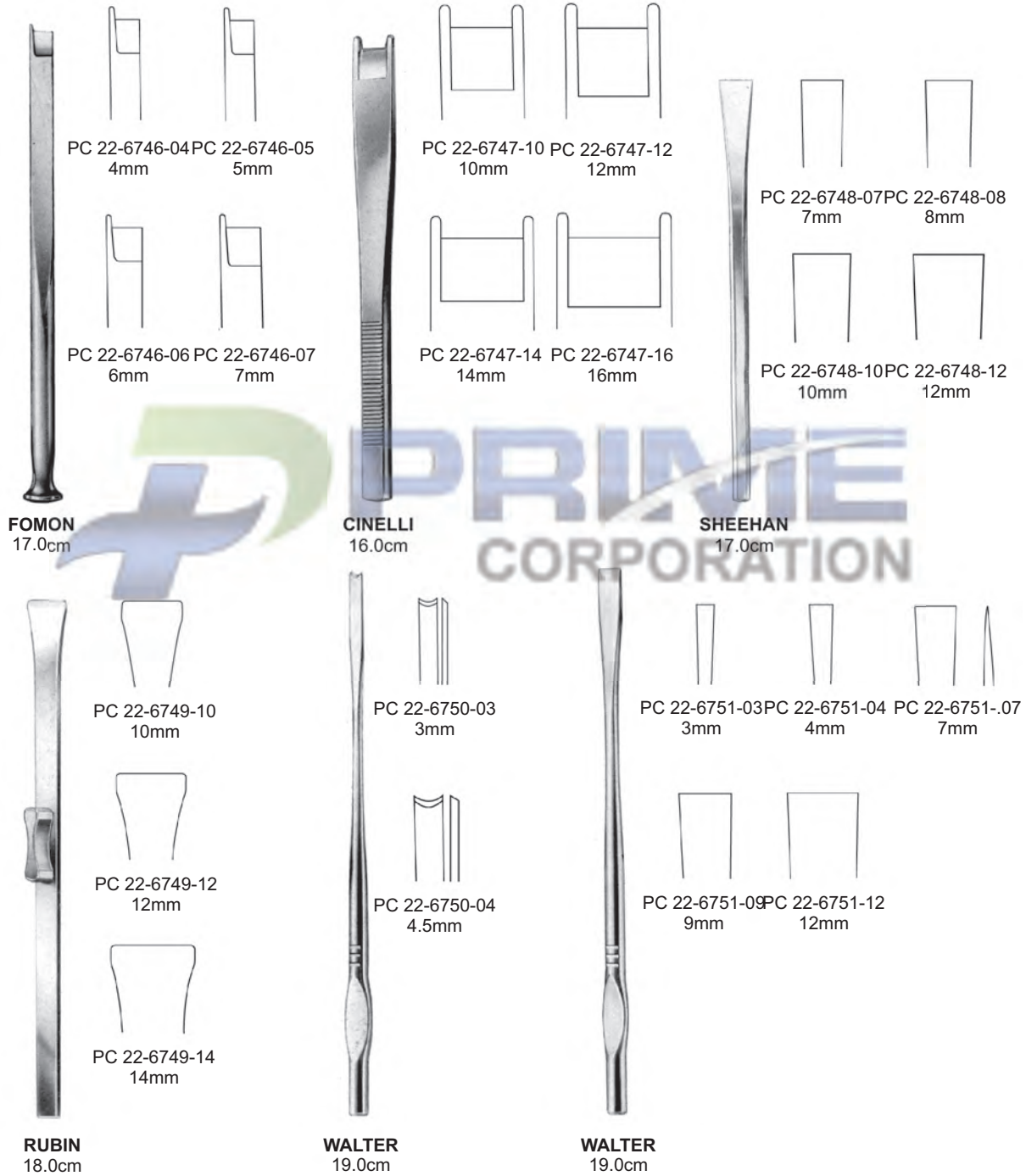

- EN —● Nasal Rasps, Bone Files, Antrum Rasps
- DE —● Knochenfeilen, Nasenraspeln, Antrumraspeln
- ES —● Limas para huesos, escofinas nasales, escofinas para el antro

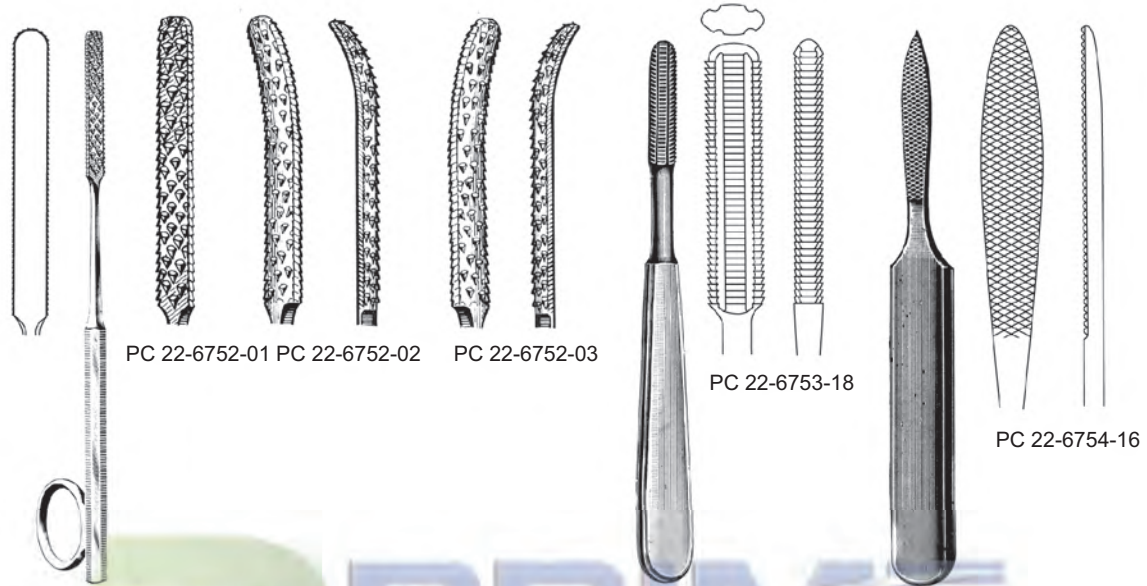

**GALLAHER**  
16.0cm

**MALTZ**  
18.0cm

**JOSEPH**  
16.0cm

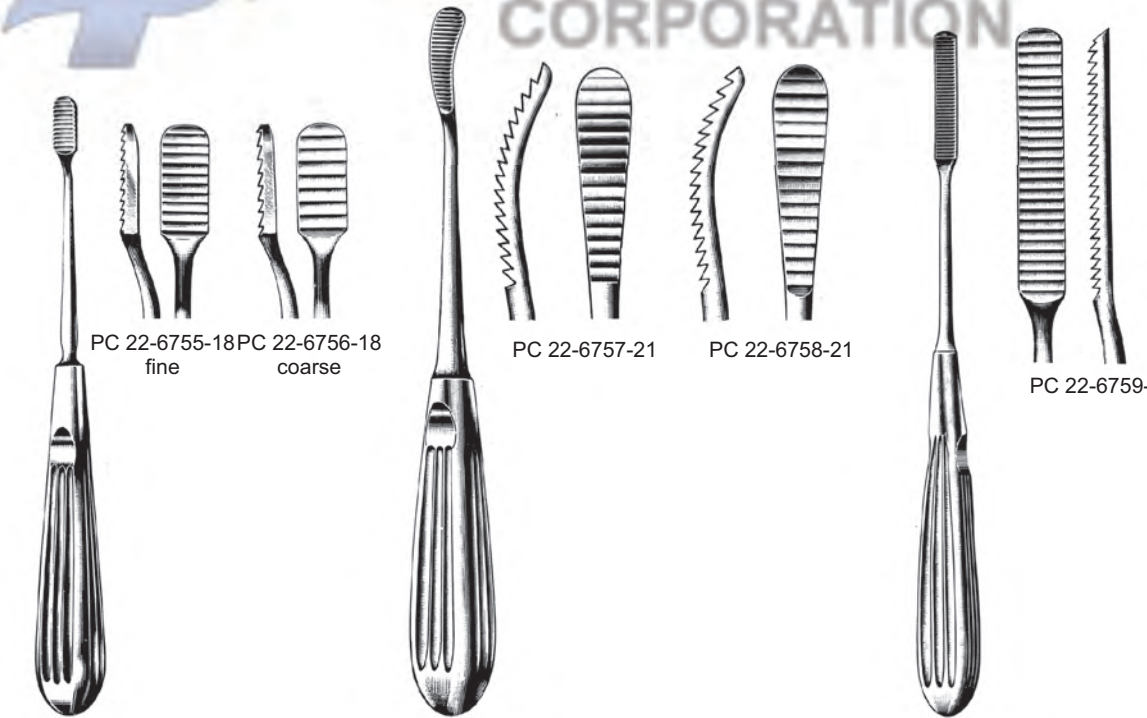

**LEWIS**  
18.0cm

**AUFRICHT**  
21.0cm

**COTTLE**  
21.0cm

- Antrum and Nasal Rasps ● EN
- Antrum und Nasenraspeln ● DE
- Escofinas para el antro y nasales ● ES



**WIENER**  
18.0cm



PC 22-6760-18



PC 22-6761-18



**FOMON**  
PC 22-6762-21  
21.0cm



- EN —● Nasal Retractors, Nasal Hooks
- DE —● Nasenhaken, Nasenhäkchen
- ES —● Separadores nasales, ganchitos nasales



**KILNER**  
PC 22-6763-10  
10.0cm



**CONVERSE**  
PC 22-6764-12  
12.0cm



**AUFRICT**  
PC 22-6765-16  
16.0cm



**AUFRICT**  
PC 22-6766-19  
19.0cm



15.0cm



PC 22-6767-01



PC 22-6767-02



PC 22-6767-03



**LANGE**  
PC 22-6768-22  
22.0cm



**FOMON**  
PC 22-6769-17  
17.0cm



**COTTLE**  
PC 22-6770-16  
16.0cm



**FREER**  
PC 22-6771-15  
15.0cm



Skin Grasping Forceps and Alar Hooks ● EN  
 Hautfasspinzetten und Nasenflügelhäkchen ● DE  
 Pinzas para piel y ganchitos para alas de nariz ● ES



**OGURA**  
PC 22-6772-11  
11.0cm



**COTTLE**  
PC 22-6773-11  
11.0cm



**COTTLE**  
PC 22-6774-14  
14.0cm



**COTTLE**  
15.0cm



PC 22-6775-14



PC 22-6775-01



PC 22-6775-02



**FOMON**  
PC 22-6776-16  
16.0cm



**COTTLE-NEIVERT**  
PC 22-6777-20  
20.0cm

- EN —● Septum Suture Needles, Nasal Retractors
- DE —● Septum Suture Needles, Nasal Retractors
- ES —● Agujas para sutura del tabique nasal, separadores nasales



PC 22-6778-01 PC 22-6778-02 PC 22-6778-03 PC 22-6778-04 PC 22-6778-05



PC 22-6778-06 PC 22-6778-07 PC 22-6778-08 PC 22-6778-09



**COTTLE**  
PC 22-6779-14  
14.0cm



**NEIVERT**  
PC 22-6780-16  
16.0cm



**COTTLE**  
PC 22-6781-15  
15.0cm



**COTTLE**  
PC 22-6782-15  
15.0cm



**AUFRICHT**  
PC 22-6783-13  
13.5cm

Sharp Currettes    ● — EN  
 Scharfe Lafel und Kuretten    ● — DE  
 Ceretas cortantes    ● — ES



PC 22-6784-01 PC 22-6784-02 PC 22-6784-03

PC 22-6784-04 PC 22-6784-05 PC 22-6784-06

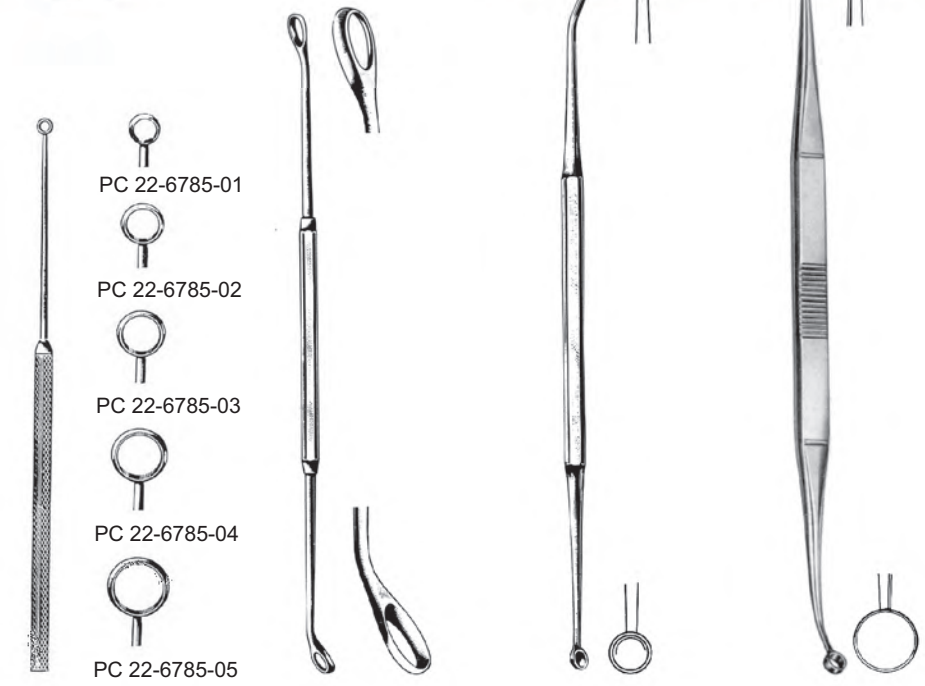

**MYLES**  
17.0cm

PC 22-6785-01

PC 22-6785-02

PC 22-6785-03

PC 22-6785-04

PC 22-6785-05

PC 22-6786-12  
12.0cm

**PRATT**  
PC 22-6787-21  
21.0cm

**FAULKNER**  
PC 22-6788-21  
21.0cm

**COAKLEY**  
17.0cm

- EN —● Rhinoplastic Instruments etc.  
 DE —● Instrumente zur Nasanplastik usw.  
 ES —● Instrumentos para la plastica nasal etc.



PC 22-6791-23  
straight

PC 22-6792-23  
left

PC 22-6793-23  
right



**KRESSNER**  
PC 22-6789-20  
20.0cm

**ASCH**  
PC 22-6790-23  
23.0cm

**COTTLE-WALSHAM**  
23.0cm



Adenoid Curettes ●— EN  
 Ringmesser ●— DE  
 Cuchillos para vegetaciones adenoides ●— ES



**BECKMANN**  
22.0cm



**BECKMANN**  
22.0cm



PC 22-6794-01  
PC 22-6795-01



PC 22-6794-02  
PC 22-6795-02



PC 22-6794-03  
PC 22-6795-03



PC 22-6794-04  
PC 22-6795-04



PC 22-6794-05  
PC 22-6795-05



PC 22-6794-06  
PC 22-6795-06



**BECKMANN**  
22.0cm



PC 22-6796-01



PC 22-6796-02



PC 22-6796-03

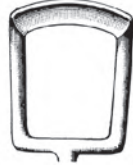

PC 22-6796-04



PC 22-6796-05



**ST. CLAIR-THOMSON**  
21.0cm



PC 22-6797-08  
8mm



PC 22-6797-10  
10mm



PC 22-6797-12  
12mm



PC 22-6797-14  
14mm



PC 22-6797-16  
16mm



PC 22-6797-18  
18mm

- EN —● Antrum Retractor, Adentomes
- DE —● Kierfer hohlenhaken, Tonsillotome
- ES —● Separador para seno maxilar, Adenotomos



**BRUENINGS-BRUNK**  
PC 22-6798-21  
21.5cm



**LA FORCE**  
25.0cm

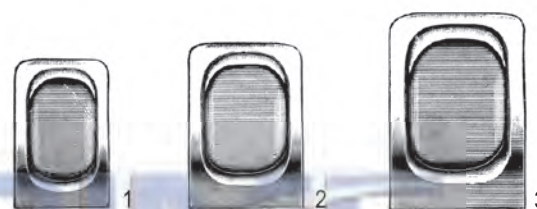

with unperforated blade  
PC 22-6799-01 Fig. 1  
PC 22-6799-02 Fig. 2  
PC 22-6799-03 Fig. 3

with perforated blade  
PC 22-6800-01  
PC 22-6800-02  
PC 22-6800-03

spare blades  
PC 22-6801-01 Fig. 1  
PC 22-6801-02 Fig. 2  
PC 22-6801-03 Fig. 3

PC 22-6802-01  
PC 22-6802-02  
PC 22-6802-03

Antrum and Frontal Sinus Wash Cannulas ● EN  
 Kiefer-und Stirnhohlen-Spulkanulen ● DE  
 Canulas lavadoras para senos maxilar y frontal ● ES

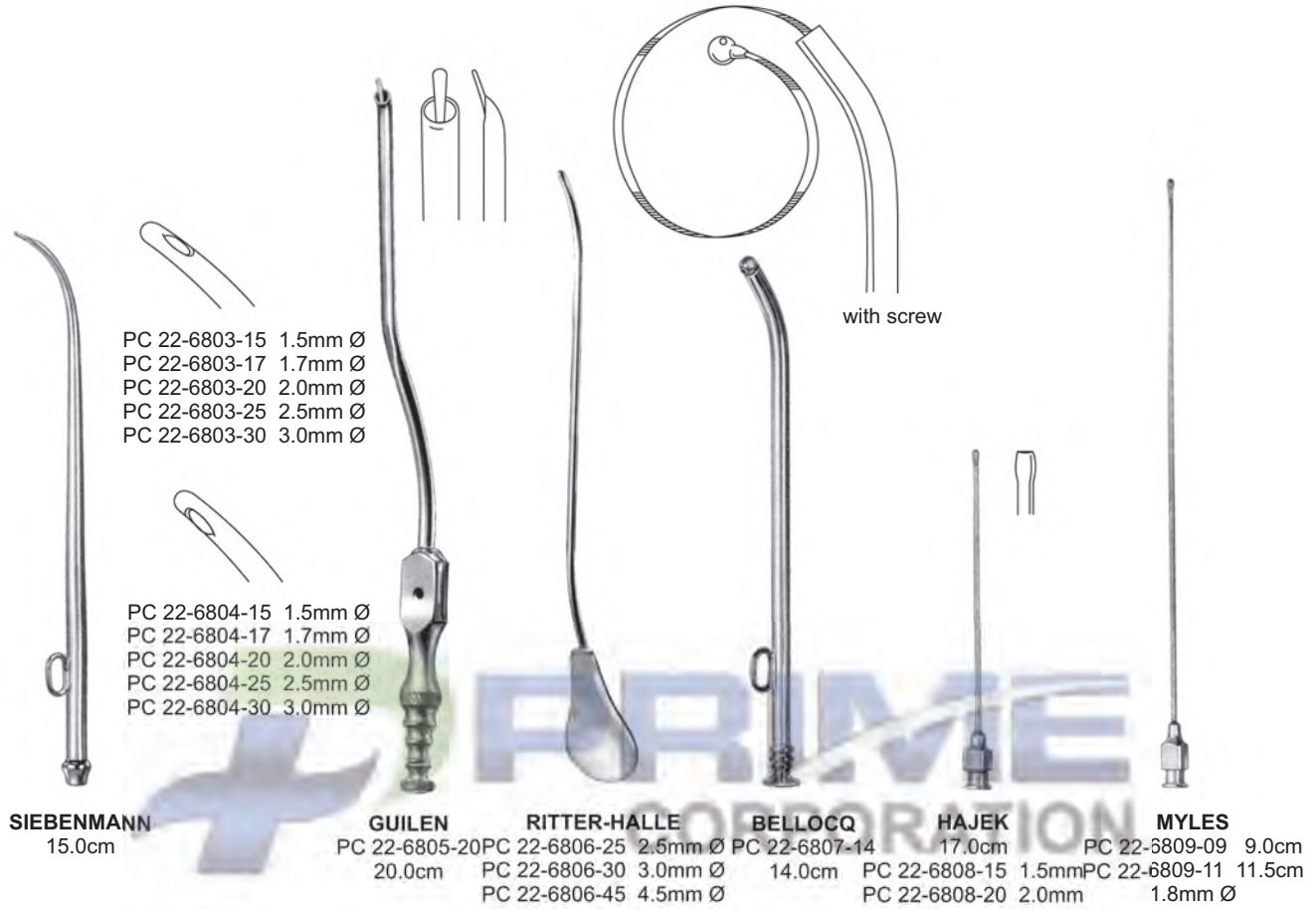

**EN** Oral Instruments

**DE** Mund instrumente

**ES** Cirugía oral

**Page 575 to 594**

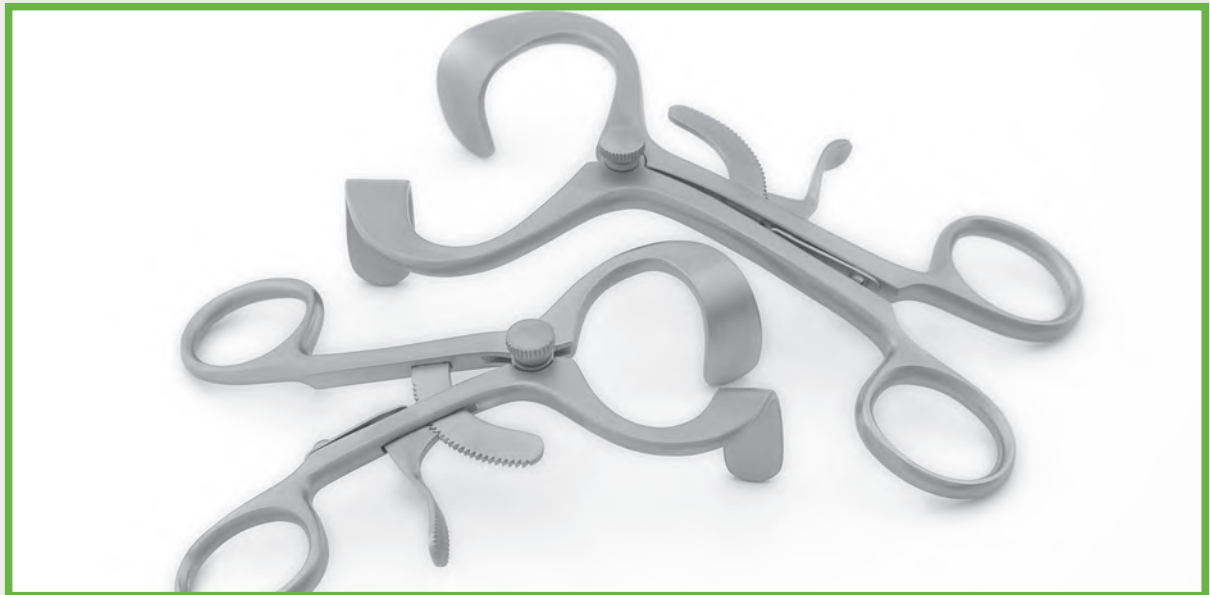

- EN —● Mouth Gags
- DE —● Mundsperrer
- ES —● Abre-bocas

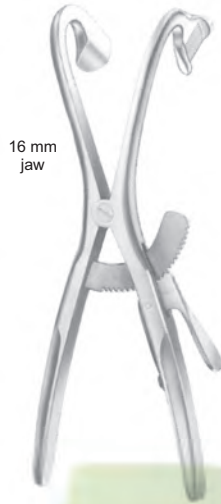

16 mm  
jaw

**DENHART**  
PC 23-6901-12  
12 cm/4 3/4"



Silicon jaws  
only (pair)  
PC 23-6903-12

**DENHART**  
PC 23-6902-12  
12 cm/4 3/4"



**ROSER-KONIG**

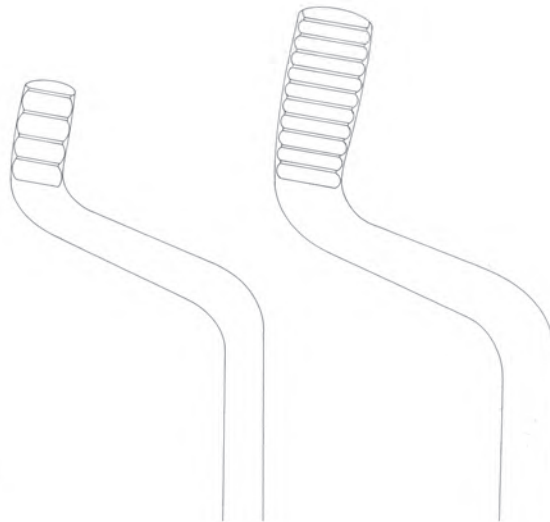

PC 23-6904-16  
16 cm/6 1/4"

PC 23-6904-19  
19 cm/7 1/2"



- Mouth Gags ● EN
- Mundsperrer ● DE
- Abre-bocas ● ES



complete, with frame, 3 tongue depressors and 2 adjustable lateral blades



**DINGMAN**  
PC 23-6905-00  
Complete set  
Fig. 1 - 3



PC 23-6906-01  
62 mm x 26 mm



PC 23-6907-02  
65 mm x 30 mm



PC 23-6908-03  
78 mm x 32 mm

- EN —● Mouth Gags
- DE —● Mundsperrer
- ES —● Abre-bocas

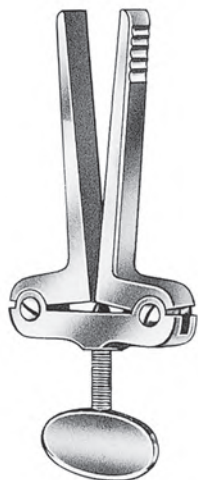

**HEISTER**  
PC 23-6909-13  
13 cm/5 1/8"



PC 23-6911-11  
Spare rubber

**MOLT**  
PC 23-6910-11  
11 cm/4 3/8"



PC 23-6913-13  
Spare Rubber

**MOLT**  
PC 23-6912-13  
13 cm/5 1/8"



**SPREADING**  
47 mm

**OBWEGESER**  
PC 23-6914-11  
11 cm/4 3/8"

- Mouth Gags ●— EN
- Mundsperrer ●— DE
- Abre-bocas ●— ES



**WHITEHEAD**

- PC 23-6915-11 11 cm/4 1/4"
- PC 23-6915-13 13 cm/5 1/8"
- PC 23-6915-15 15 cm/5 7/8"



**JENNINGS**

- PC 23-6916-09 9 cm/3 1/2"
- PC 23-6916-11 11 cm/4 1/8"
- PC 23-6916-13 13 cm/5 1/8"
- PC 23-6916-15 15 cm/5 7/8"

- EN —● Mouth Gags
- DE —● Mundsperrer
- ES —● Abre-bocas

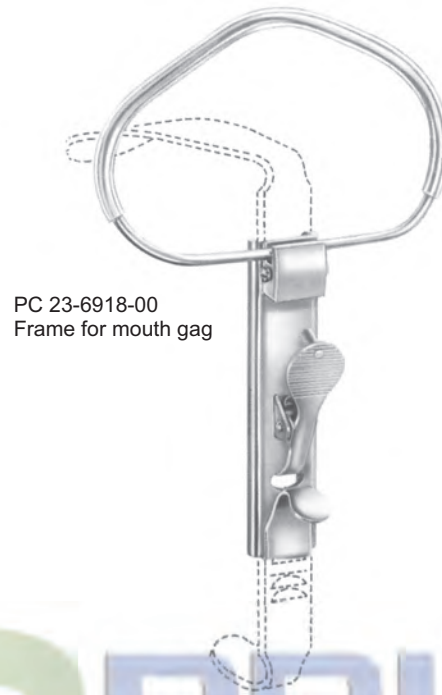

PC 23-6918-00  
Frame for mouth gag



**McLVOR**  
PC 23-6917-00  
Complete with 3  
tongue depressors

**Tongue Depressors**



Fig. 1  
PC 23-6919-01  
100 x 25 mm



Fig. 2  
PC 23-6920-02  
85 x 25 mm



Fig. 3  
PC 23-6921-03  
75 x 25 mm

- Mouth Gags ●— EN
- Mundsperrer ●— DE
- Abre-bocas ●— ES

PC 23-6923-00  
Frame for mouth gag



**DAVIS-BOYLE**  
PC 23-6922-00  
Complete, consisting of frame  
and 5 tongue depressors no. 1 - 5

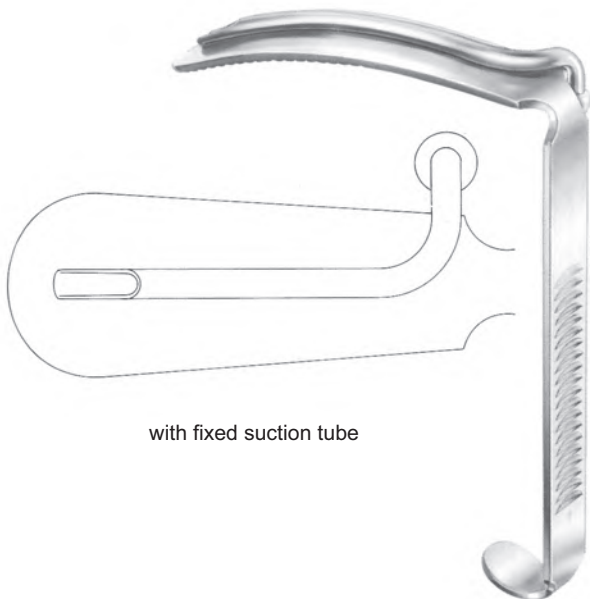
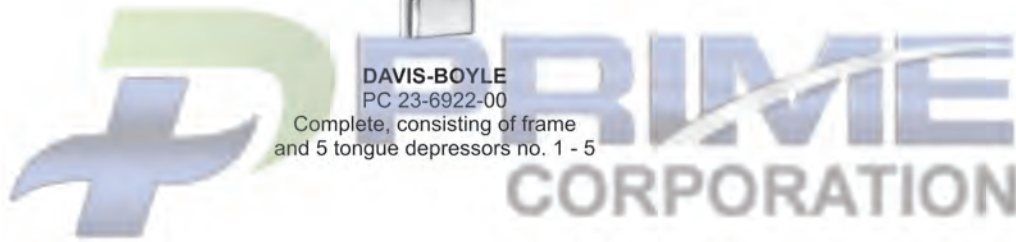

with fixed suction tube

Fig. 1  
PC 23-6924-01  
110 x 28 mm



Fig. 2  
PC 23-6925-02  
95 x 27 mm



Fig. 3  
PC 23-6926-03  
80 x 27 mm



Fig. 4  
PC 23-6927-04  
65 x 26 mm



Fig. 5  
PC 23-6928-05  
30 x 20 mm



- EN —● Mouth Gags
- DE —● Mundsperrer
- ES —● Abre-bocas

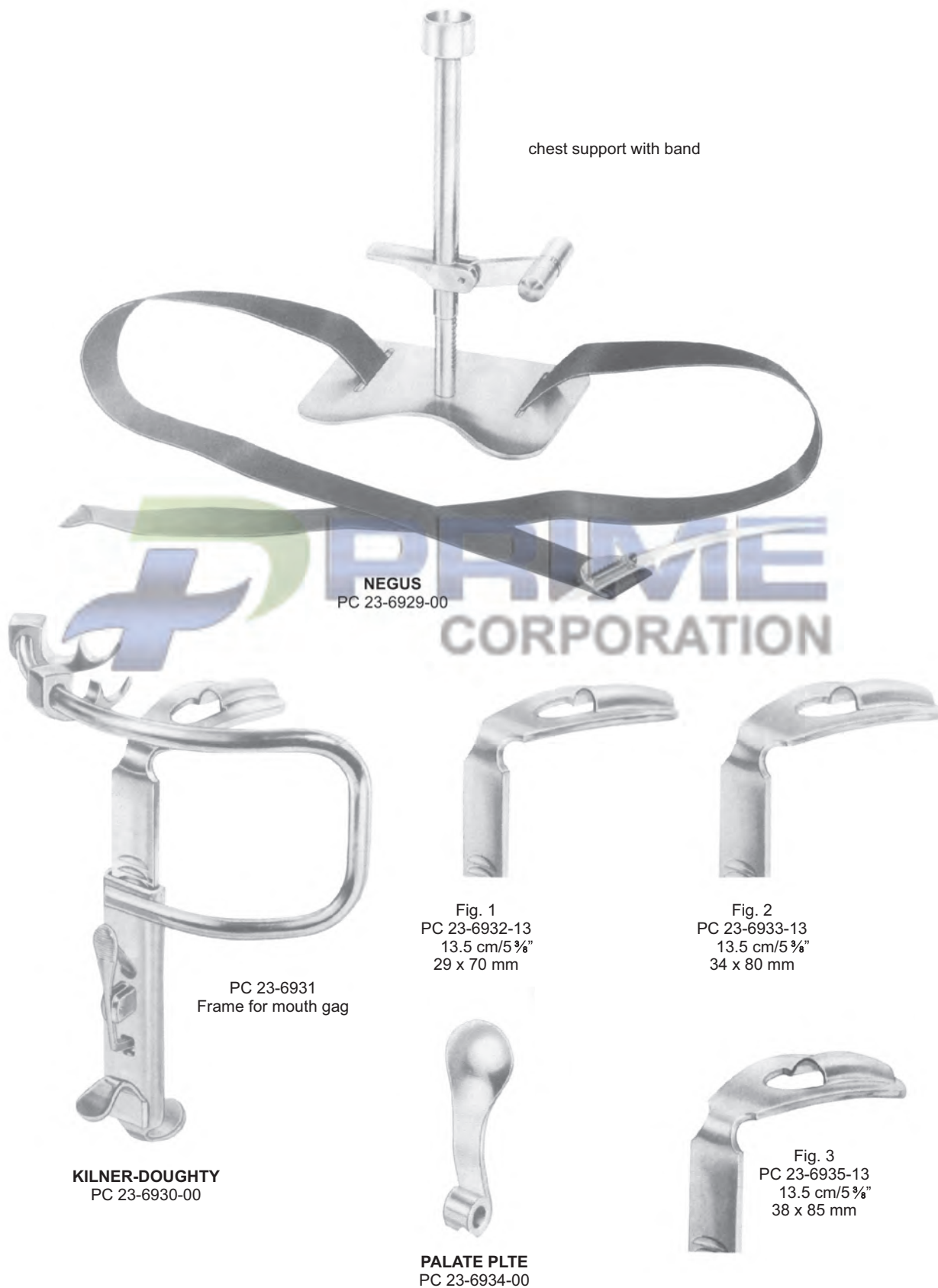

complete, consisting of frame and 3 tongue depressors  
no. 1 to 3, 2 tooth plates and 1 palate plate

- Mouth Gags ● EN
- Mundsperrer ● DE
- Abre-bocas ● ES

**NEUKAM**  
PC 23-6937-00  
frame for mouth gag only



**NEUKAM**  
PC 23-6936-00  
complete with frame and  
3 tongue depressors

Tongue Depressor  
fenestrated blade for suction



Fig. 1  
PC 23-6938-01

Fig. 2  
PC 23-6939-02

Fig. 3  
PC 23-6940-03

EN —● Tongue Holding Forceps

DE —● Zungenzangen

ES —● Pinzas Tira-lengua



**COLLIN**  
 PC 23-6941-16 16 cm/6 1/4"  
 PC 23-6941-18 18 cm/7 1/8"



**YOUNG**  
 PC 23-6942-16  
 16 cm/6 1/4"

PC 23-6943-16  
 rubber inserts, only (pair)

Tongue Spatulas ● EN  
 Zungenspatel ● DE  
 Espátulas Linguales ● ES



PC 23-6944-15  
 15 cm/5 7/8"  
 wood  
 19 mm



PC 23-6945-15  
 15 cm/5 7/8"  
 plastic



**BRUNINGS**  
 PC 23-6946-19  
 19 cm/7 1/2"

16 mm



PC 23-6947-14  
 14.5 cm/5 3/4"

19 mm



23 mm

PC 23-6948-14  
 14 cm/5 1/2"



**DOYEN**

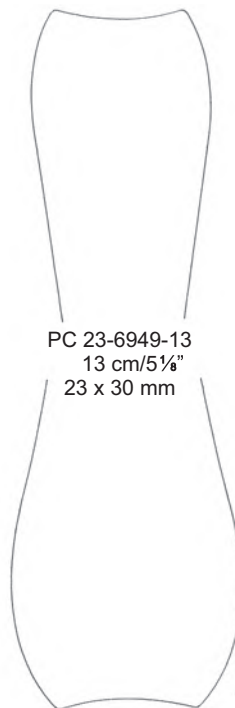

PC 23-6949-13  
 13 cm/5 1/8"  
 23 x 30 mm



PC 23-6949-16  
 16 cm/6 1/4"  
 30 x 33 mm

- EN —● Tongue Depressors
- DE —● Zungendrucker
- ES —● Abajalenguas

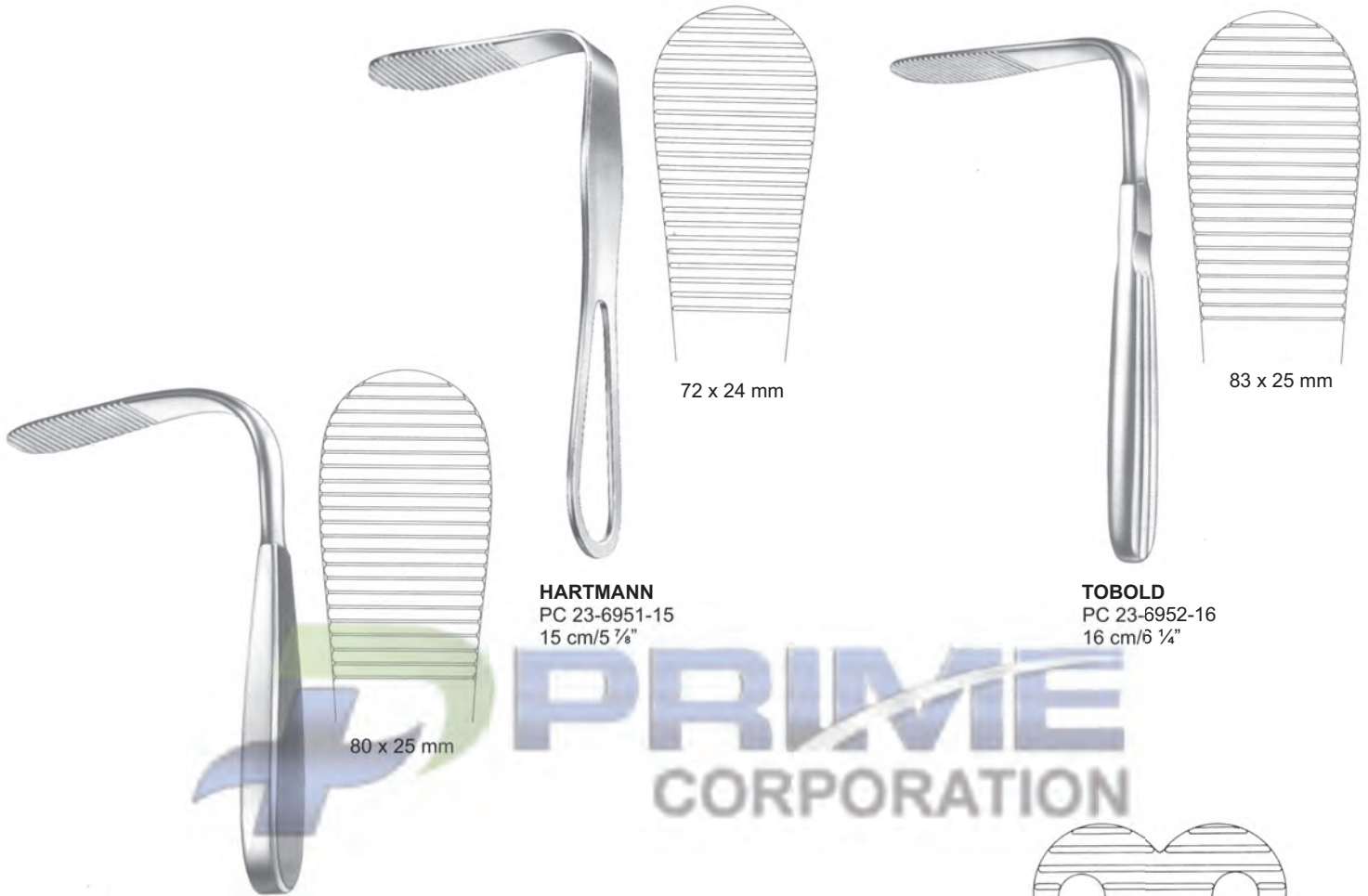

**HARTMANN**  
PC 23-6951-15  
15 cm/5 7/8"

**TOBOLD**  
PC 23-6952-16  
16 cm/6 1/4"

**TOBOLD**  
PC 23-6950-15  
15 cm/5 7/8"



**BUCHWALD**  
PC 23-6953-18  
18 cm/7 1/8"



**ANDREW**  
PC 23-6954-11  
11 cm/4 3/8"

**WIEDER**

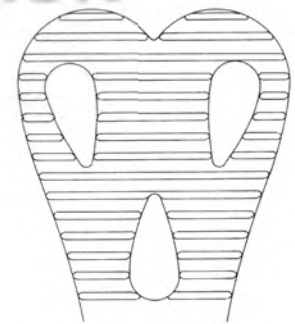

PC 23-6955-14  
14 cm/5 1/2"  
36 mm



PC 23-6955-15  
15 cm/5 7/8"  
43 mm



Lip and Cheek Retractors ● EN  
 Lippen- und wangenhalter ● DE  
 Separadores para labios y mejillas ● ES

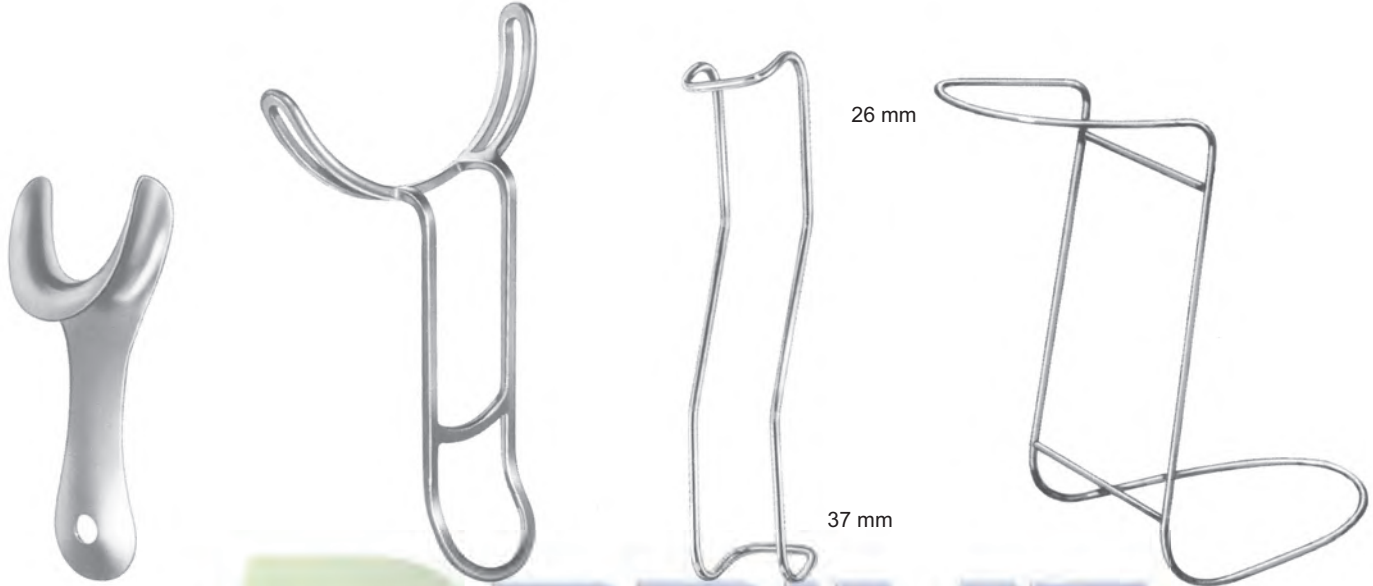

**MARTIN-SIMPLEX**  
 PC 23-6956-10  
 10.5 cm/4 1/8"

PC 23-6957-14  
 14 cm/5 1/2"  
 Vestibulum  
 retractor

**STERNBERG**  
 PC 23-6958-14  
 14 cm/5 1/2"

**OBWEGESER**  
 PC 23-6959-12  
 12 cm/4 3/4"



**BISHOP**  
 PC 23-6960-13  
 13.5 cm/5 3/8"

**CAWOOD-MINNESOTA**  
 PC 23-6961-15  
 15.5 cm/6 1/8"

**CAWOOD-MINNESOTA**  
 PC 23-6962-14  
 14.5 cm/5 3/4"

- EN —● Ramus retractors, Chin Retractor, Channel Retractors  
 DE —● Ramushaken, kinnhalter, Progenierinnen  
 ES —● Separadores para el ramo, Gancho de menton, Separadores mandibulares

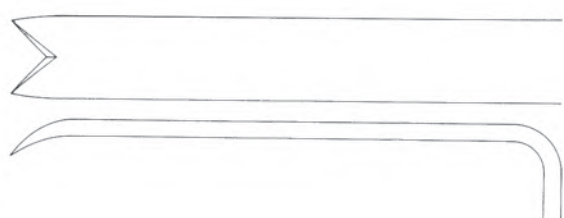

72 x 10 mm



**OBWEGESER**  
 PC 23-6963-22  
 22 cm/8 ¾"



**OBWEGESER**  
 PC 23-6964-16  
 16.5 cm/6 ½"



**OBWEGESER**

PC 23-6965-16  
 16 cm/6 ¼"  
 8 mm

PC 23-6966-16  
 16 cm/6 ¼"  
 10 mm

Soft Tissue Retractors ● EN  
 Weichteilhaken ● DE  
 Separadores para partes blandas ● ES



PC 23-6967-22  
 22.5 cm/8 3/4"  
 43 x 11 mm



PC 23-6967-23  
 23 cm/9"  
 57 x 11 mm



PC 23-6968-23  
 23 cm/9"  
 80 x 16 mm



43 x 10 mm



OBWEGESER



OBWEGESER  
 PC 23-6969-22  
 22 cm/8 3/4"  
 Nasal Spine Retractor

- EN —● Periosteal Elevators
- DE —● Raspatorien
- ES —● Periostotomos



**OBWEGESER**  
17.5 cm/6 7/8"



PC 23-6970-17



PC 23-6971-17



**KRENKEL**  
24.5 cm/9 5/8"



PC 23-6972-24  
Periosteal Elevator



PC 23-6973-24  
Periosteal Elevator



PC 23-6974-24  
Condylar repositioning  
instrument  
Fig. 11



PC 23-6975-24  
Fig. 12



Periosteal Elevators ●— EN  
 Raspatorien ●— DE  
 Periostotomos ●— ES



**OBWEGESER**  
17.5 cm/6 7/8"



PC 23-6976-17  
6 mm



PC 23-6977-17  
7 mm



PC 23-6978-17  
9 mm



PC 23-6979-17



**OBWEGESER**  
20 cm/7 7/8"



PC 23-6980-20  
5 mm



PC 23-6981-20  
7 mm



PC 23-6982-20  
9 mm



- EN —● Elevators, Osteotomes
- DE —● Elevatorien, Osteotome
- ES —● Elevadores, Osteotomos



**OBWEGESER**  
PC 23-6983-20  
20.5 cm/8 1/8"

**OBWEGESER**  
PC 23-6984-20  
20.5 cm/8 1/8"



PC 23-6985-15  
2.5 mm

PC 23-6986-15  
4.0 mm

PC 23-6987-15  
6.5 mm

**OBWEGESER**  
15 cm/5 7/8"

- Raspatories, Osteotomes, Awls ●— EN
- Raspatorien, Osteotome, Ahlen ●— DE
- Legras, Osteotomos, Leznas ●— ES



**OBWEGESER**  
PC 23-6988-23  
23.5 cm/9 ¼"



PC 23-6989-18



PC 23-6990-18

**OBWEGESER**  
18.5 cm/7 ¼"



**OBWEGESER**  
PC 23-6991-18  
18 cm/7 ⅛"



**OBWEGESER**  
PC 23-6992-14  
14 cm/5 ½"



**OBWEGESER**  
PC 23-6993-23  
23 cm/9"

EN —● Awls  
 DE —● Ahlen  
 ES —● Leznas

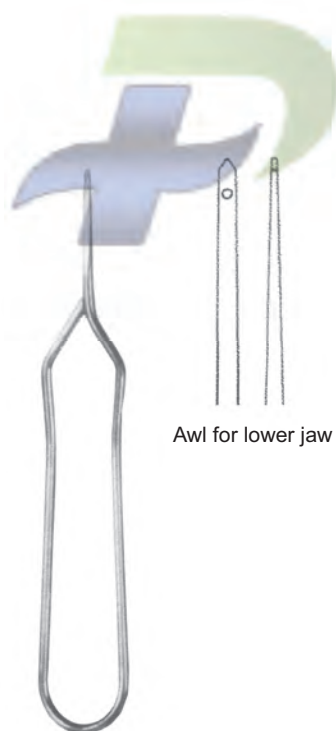

Awl for lower jaw

**KELSEY-FRY**  
 PC 23-6994-15  
 15 cm/5 7/8"

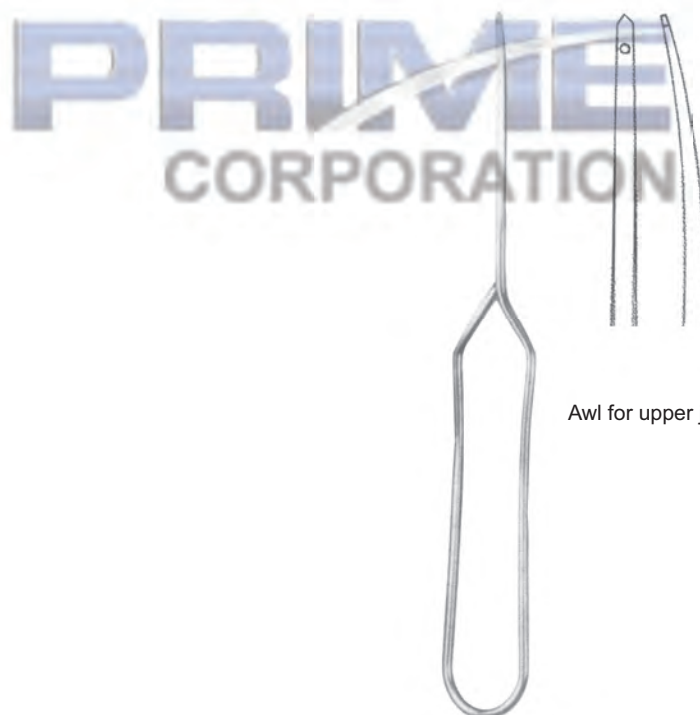

Awl for upper jaw

**KELSEY-FRY**  
 PC 23-6995-18  
 18 cm/7 1/8"

Disimpaction Forceps ●— EN  
 Repositionszangen ●— DE  
 Pinzas para reposición ●— ES

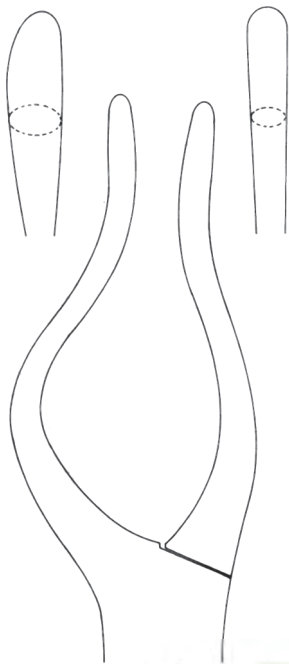

Fig. 1  
for babies

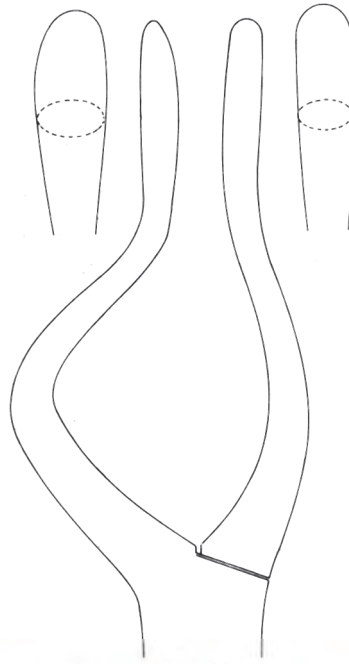

Fig. 2  
for children

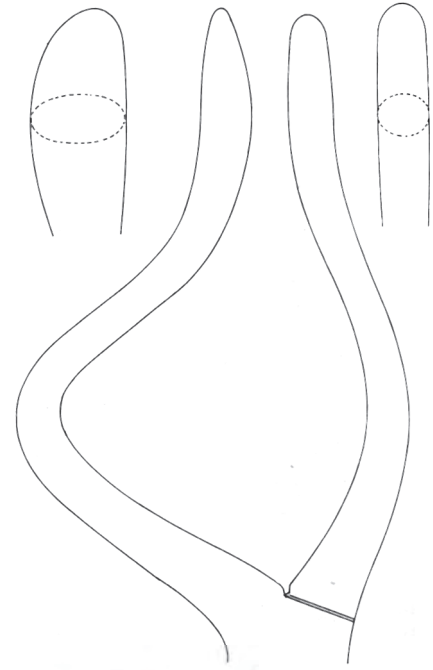

Fig. 3  
for adults



Left



Right

**ROWE**

PC 23-6996-22 Fig. 1 22.5 cm  
 PC 23-6996-23 Fig. 2 23.5 cm  
 PC 23-6996-24 Fig. 3 24.0 cm

**ROWE**

PC 23-6997-22 Fig. 1 22.5 cm  
 PC 23-6997-23 Fig. 2 23.5 cm  
 PC 23-6997-24 Fig. 3 24.0 cm

**EN** Stomach, Intestine, Rectum

**DE** Magen, Darm, Mastdarm

**ES** Estómago, Intestinos, Recto

Page 595 to 619





- EN —● Tissue Seizing, Intestinal Atrauma Tissue Forceps
- DE —● Tissue Beschlagnahme, Darm Atrauma Tissue Zange
- ES —● Aprovechando el tejido intestinal y pinzas de tejido Atrauma

4 : 5      5 : 6

**Allis**

cm	in	4 : 5	5 : 6
15	6"	PC 24-7101-15	PC 24-7102-15
19	7½"	PC 24-7101-19	PC 24-7102-19
23	9"	PC 24-7101-23	PC 24-7102-23
25	10"	PC 24-7101-25	PC 24-7102-25

**Baby-Allis**

PC 24-7103-12	12 cm/4¾"
PC 24-7103-14	14 cm/5½"

**Atrauma**

**Allis-Atrauma**

PC 24-7104-16	16 cm/6¼"
PC 24-7104-20	20 cm/8"
PC 24-7104-25	25 cm/10"
PC 24-7104-30	30 cm/12"

**Allis-Adair**  
PC 24-7105-15  
15 cm/6"

**Boys-Allis**  
PC 24-7106-15  
15 cm/6"

**Lockwood-Allis**  
PC 24-7107-16 16 cm/6¼"  
PC 24-7107-20 20 cm/8"

**Thoms-Allis**  
PC 24-7108-20  
20 cm/8"

Tissue Seizing, Intestinal Atrauma Tissue Forceps ●— EN  
 Tissue Beschlagnahme, Darm Atrauma Tissue Zange ●— DE  
 Aprovechando el tejido intestinal y pinzas de tejido Atrauma ●— ES



## Atrauma

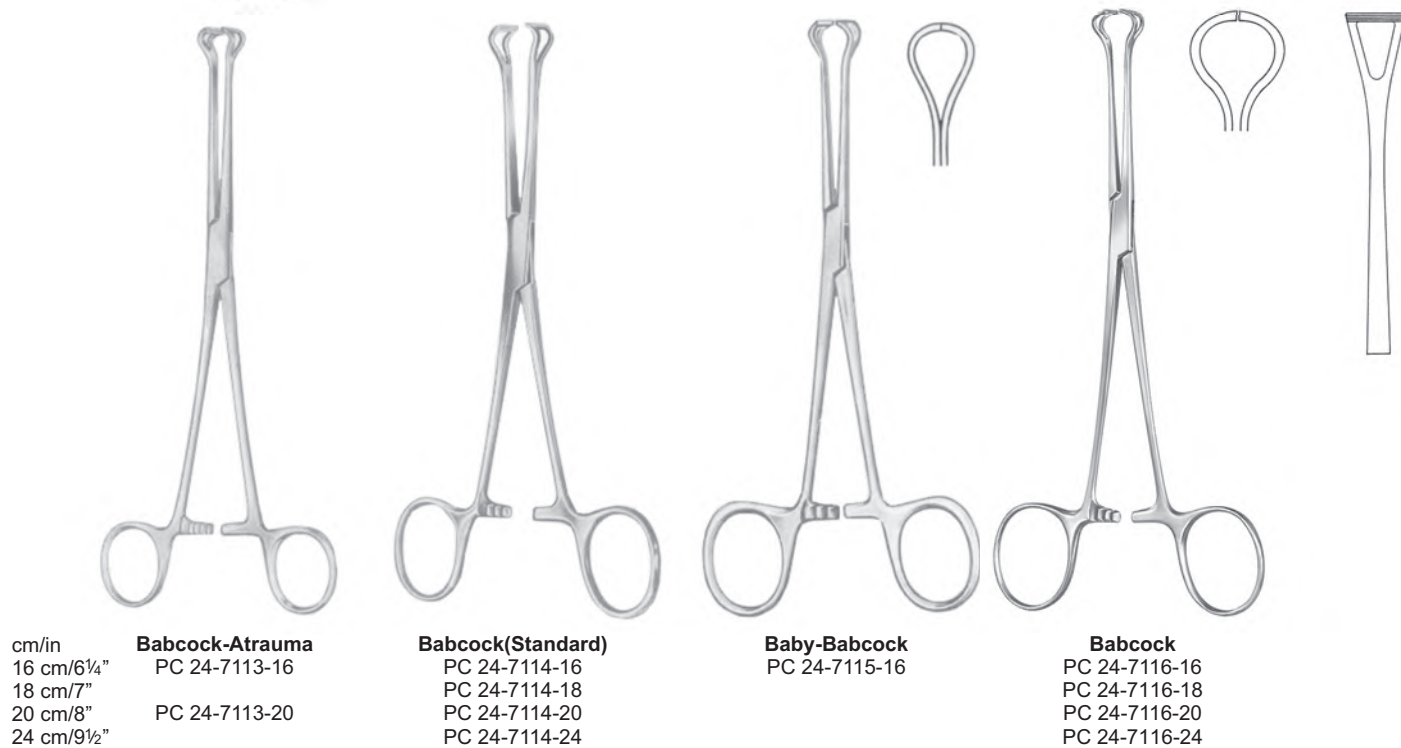

- EN —● Intestinal Tissue and Organ Grasping Forceps
- DE —● Gewebe- und organ-Faßzangen
- ES —● Pinzas para tejidos y órganos

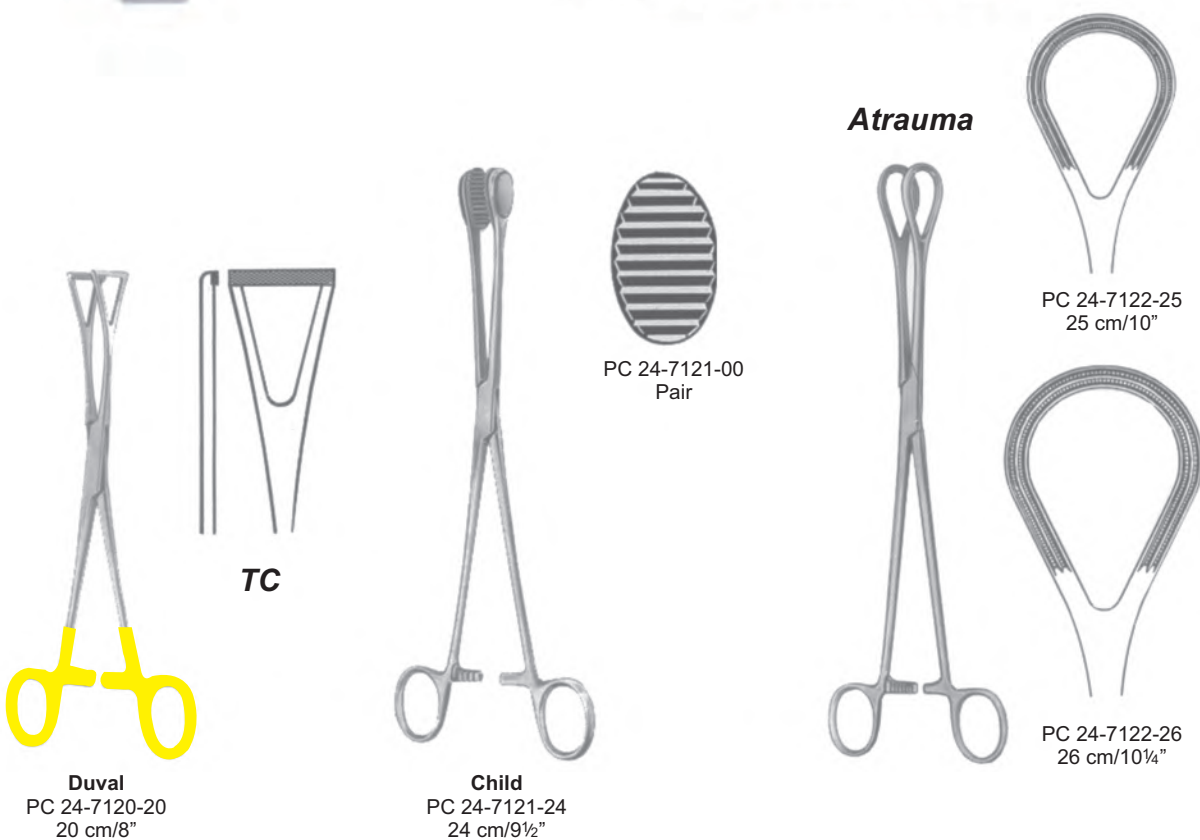

Intestinal Clamps Forceps ● EN  
 Darmklemmen ● DE  
 Pinzas-clamps intestinales ● ES

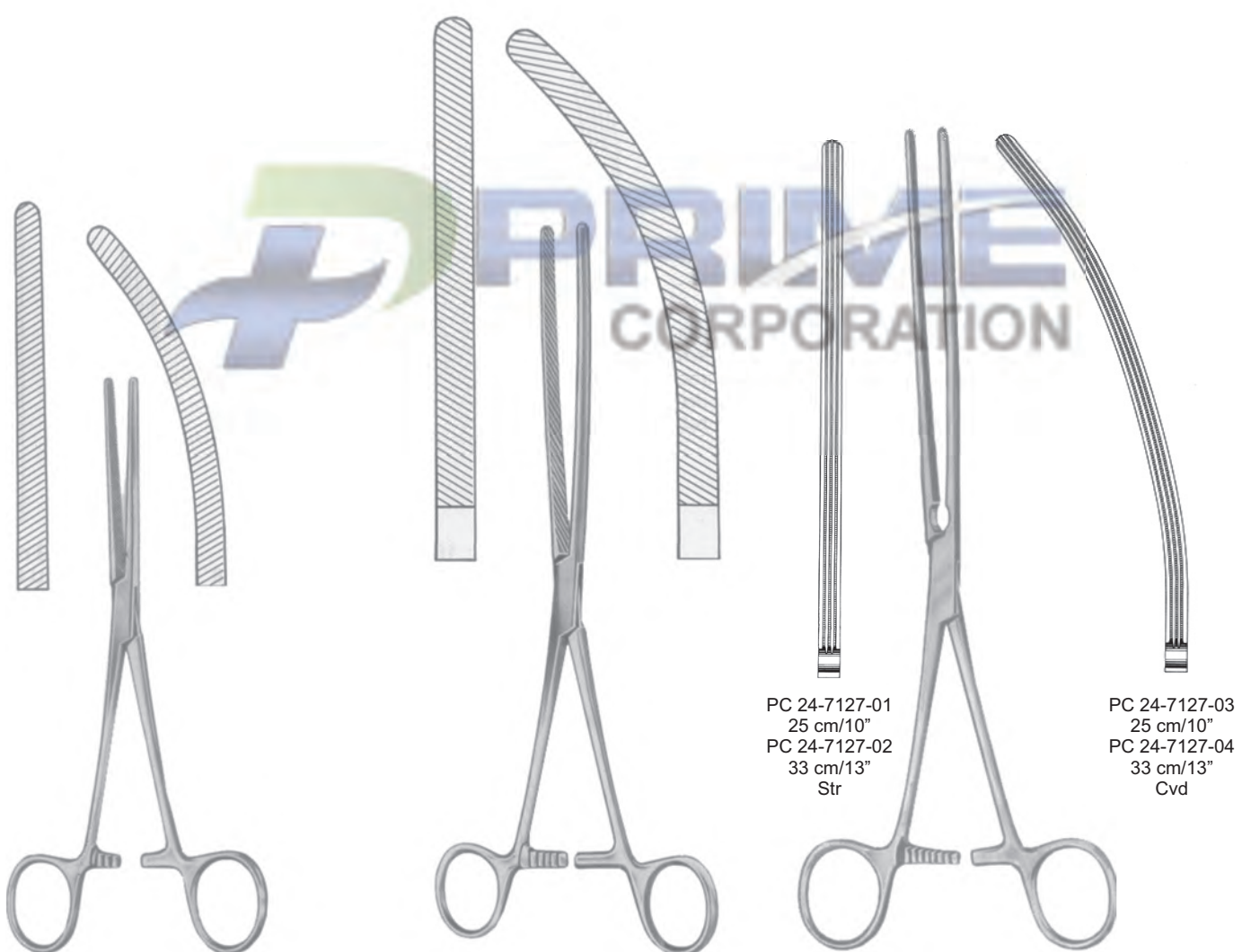

**Baby-Doyen**  
 Straight PC 24-7123-18 18 cm/7"  
 Curved PC 24-7124-18 18 cm/7"

**Doyen**  
 Straight PC 24-7125-21 21 cm/8¼" PC 24-7126-21 21 cm/8¼"  
 Curved PC 24-7125-23 23 cm/9" PC 24-7126-23 23 cm/9"

PC 24-7127-01 25 cm/10"  
 PC 24-7127-02 33 cm/13"  
 Str

PC 24-7127-03 25 cm/10"  
 PC 24-7127-04 33 cm/13"  
 Cvd

**Scudder**



- EN —● Atrauma Intestinal Clamps Forceps
- DE —● Atrauma Darmklemmen
- ES —● Atrauma pinzas-clamps intestinales

**Atrauma**



**Doyen-Atrauma**

Straight

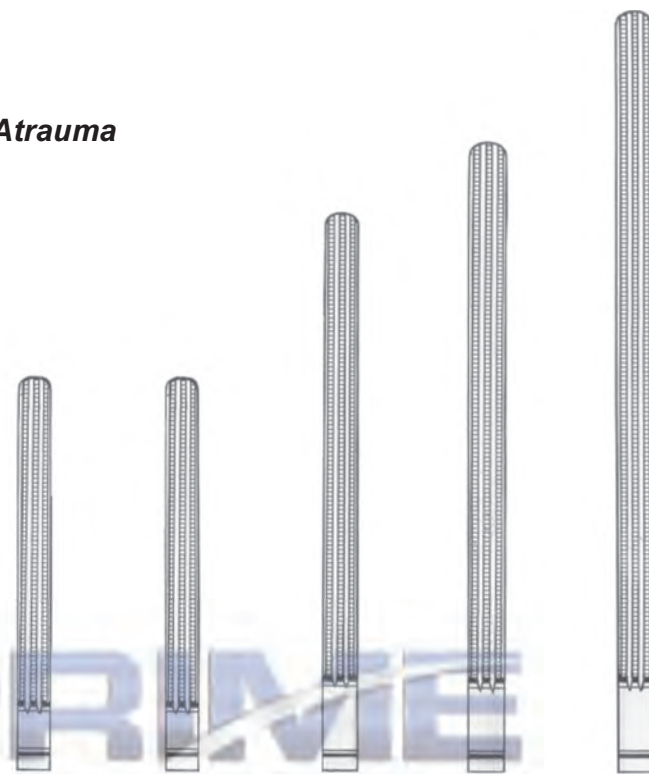

PC 24-7128-13 13 cm/5"    PC 24-7128-16 16 cm/6¼"    PC 24-7128-18 18 cm/7"    PC 24-7128-21 21 cm/8¼"    PC 24-7128-23 23 cm/9"

Curved



PC 24-7129-13 13 cm/5"    PC 24-7129-16 16 cm/6¼"    PC 24-7129-18 18 cm/7"    PC 24-7129-21 21 cm/8¼"    PC 24-7129-23 23 cm/9"



Intestinal Clamps Forceps ● EN  
 Darmklemmen ● DE  
 Pinzas-clamps intestinales ● ES

**Atrauma**



**Mayo-Robson  
 Mayo-Robson Atrauma**



PC 24-7130-21  
 21 cm/8¼"



PC 24-7131-21  
 21 cm/8¼"



PC 24-7132-23  
 23 cm/9"



PC 24-7133-23  
 23 cm/9"



PC 24-7134-25  
 25 cm/10"

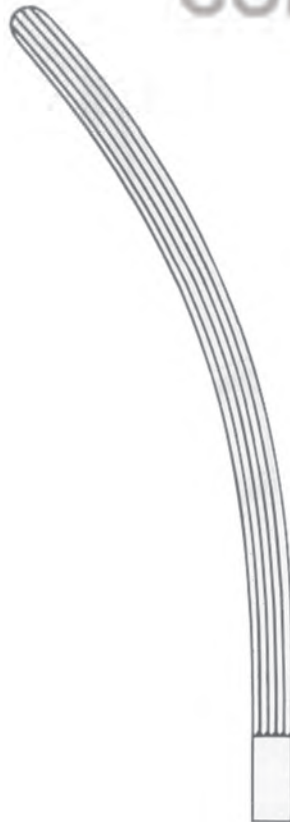

PC 24-7135-25  
 25 cm/10"



PC 24-7136-25  
 25 cm/10"

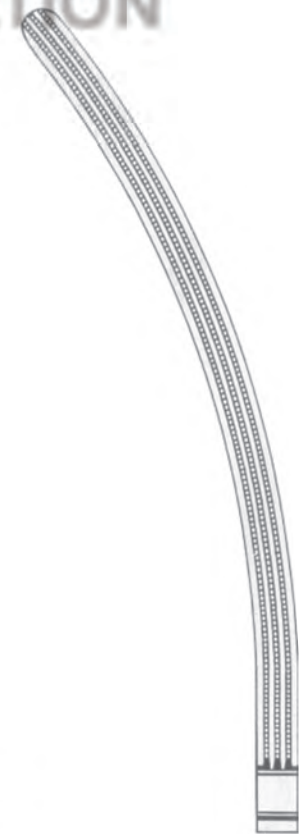

PC 24-7137-25  
 25 cm/10"

- EN —● Atrauma Intestinal Clamps Forceps
- DE —● Atrauma Darmklemmen
- ES —● Atrauma pinzas-clamps intestinales

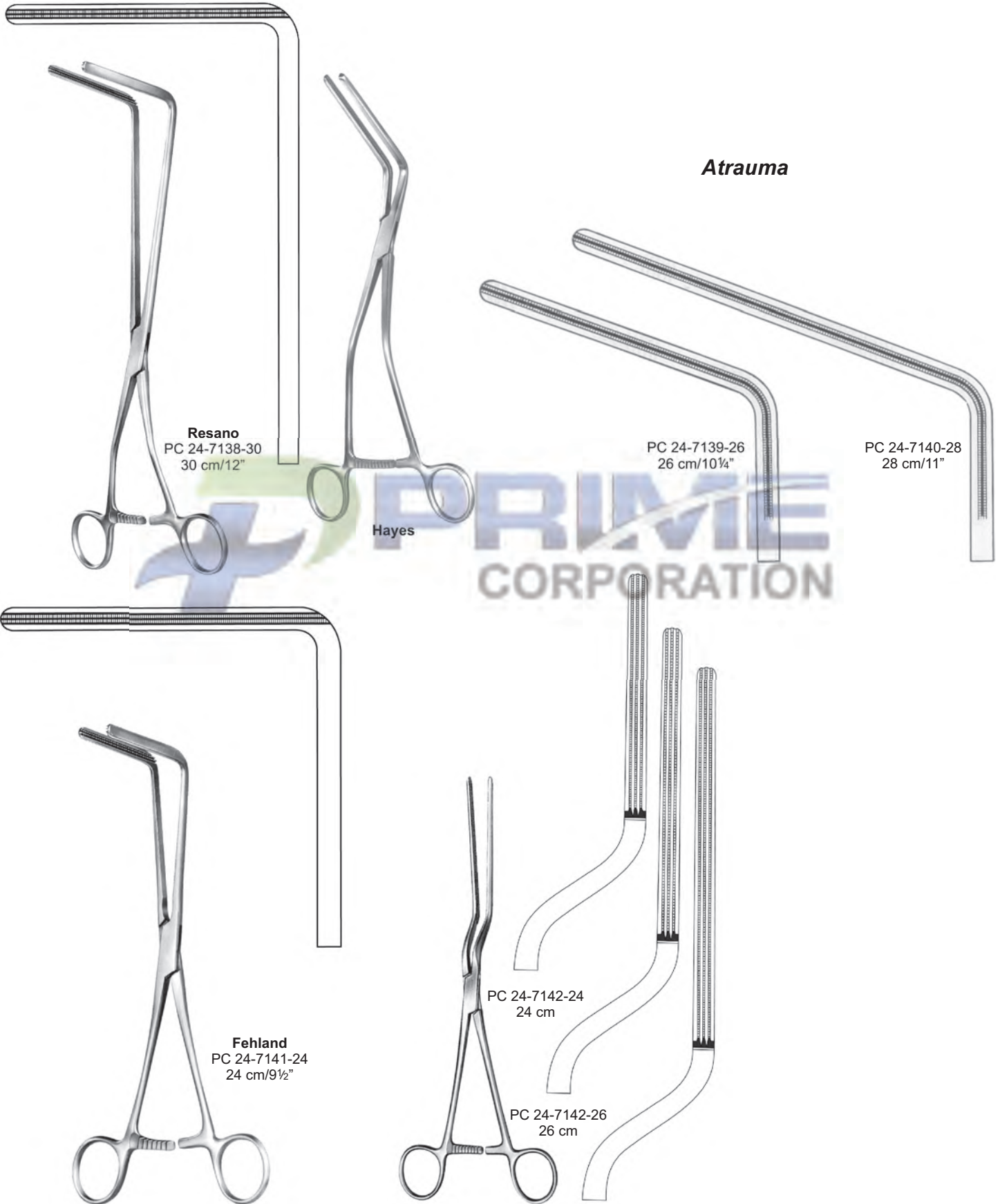

Intestinal Clamps Forceps ●— EN  
 Darmklemmen ●— DE  
 Pinzas-clamps intestinales ●— ES



Straight  
PC 24-7144-13  
13 cm/5"

**Baby-Kocher**

Curved  
PC 24-7145-13  
13 cm/5"



**Kocher**

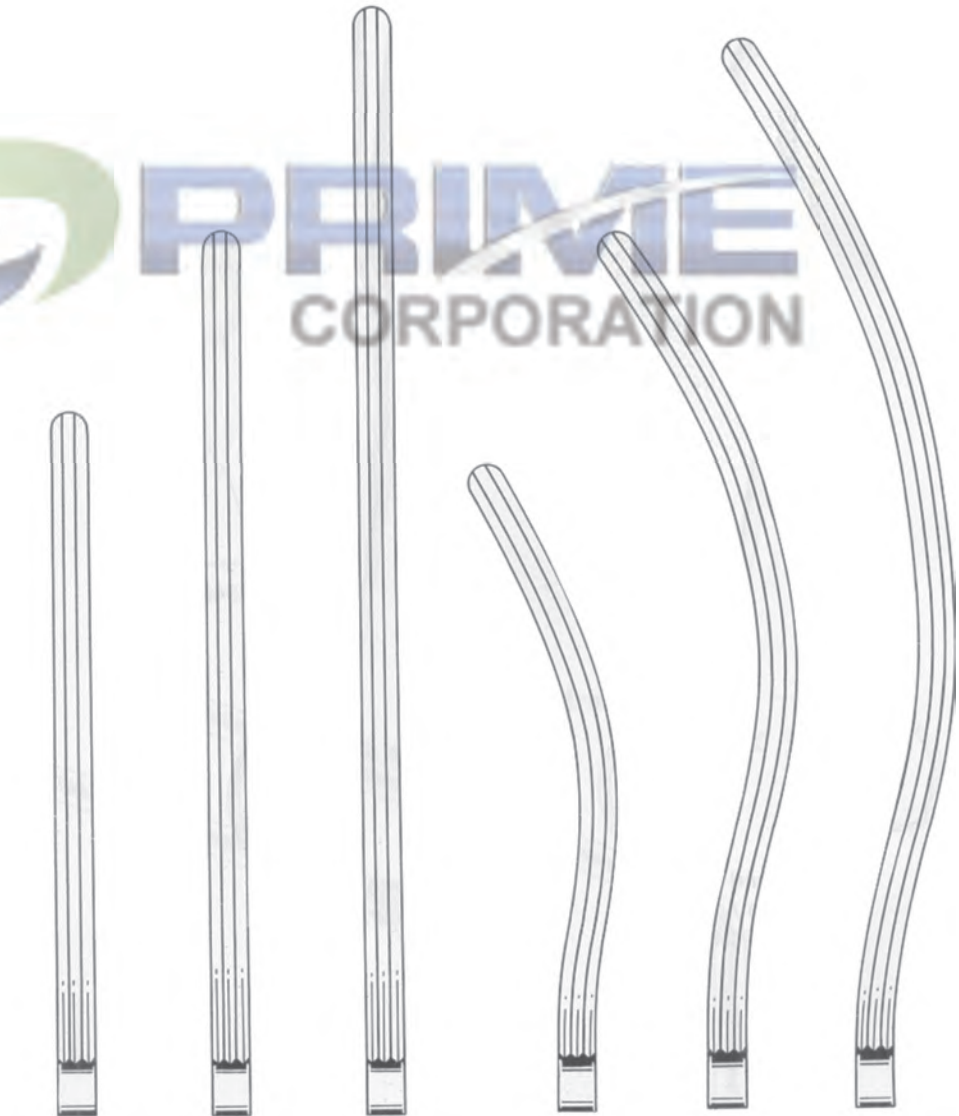

PC 24-7146-22  
22 cm/8¾"

PC 24-7146-25  
25 cm/10"

PC 24-7146-28  
28 cm/11"

PC 24-7147-22  
22 cm/8¾"

PC 24-7147-25  
25 cm/10"

PC 24-7147-28  
28 cm/11"

- EN —● Atrauma Intestinal Clamps Forceps  
 DE —● Atrauma Darmklemmen  
 ES —● Atrauma pinzas-clamps intestinales

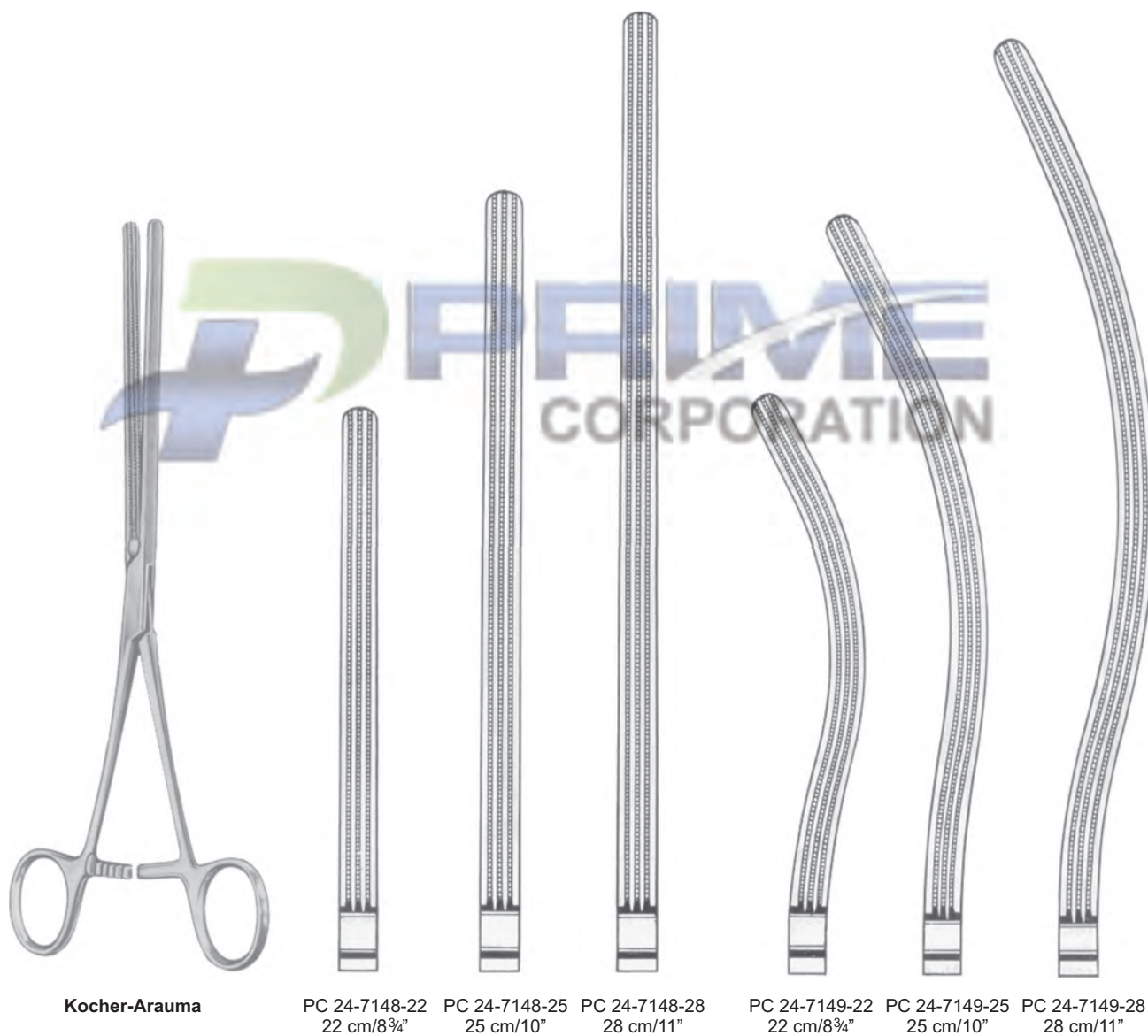
**Atrauma**



Intestinal Clamps Forceps ●— EN  
 Darmklemmen ●— DE  
 Pinzas-clamps intestinales ●— ES

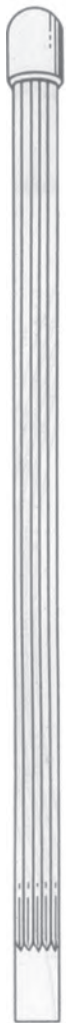

**Straight**  
 PC 24-7151-25  
 PC 24-7151-30



**Nussbaum**  
 25 cm/10"  
 30 cm/12"



**Curved**  
 PC 24-7152-25  
 PC 24-7152-30



Pylorus spreader

**Benson**  
 PC 24-7150-15  
 15.5 cm/6"



**Allen**  
 PC 24-7153-15 15.5 cm/6"  
 PC 24-7153-20 20.0 cm/8"



**Kleinschmidt**  
 PC 24-7154-12  
 12 cm/4¾"

Blindgut forceps



- EN —● Intestinal Stomach Clamps
- DE —● Darm- und Magenklappen
- ES —● Pinzas-clamps intestinales y estomacales

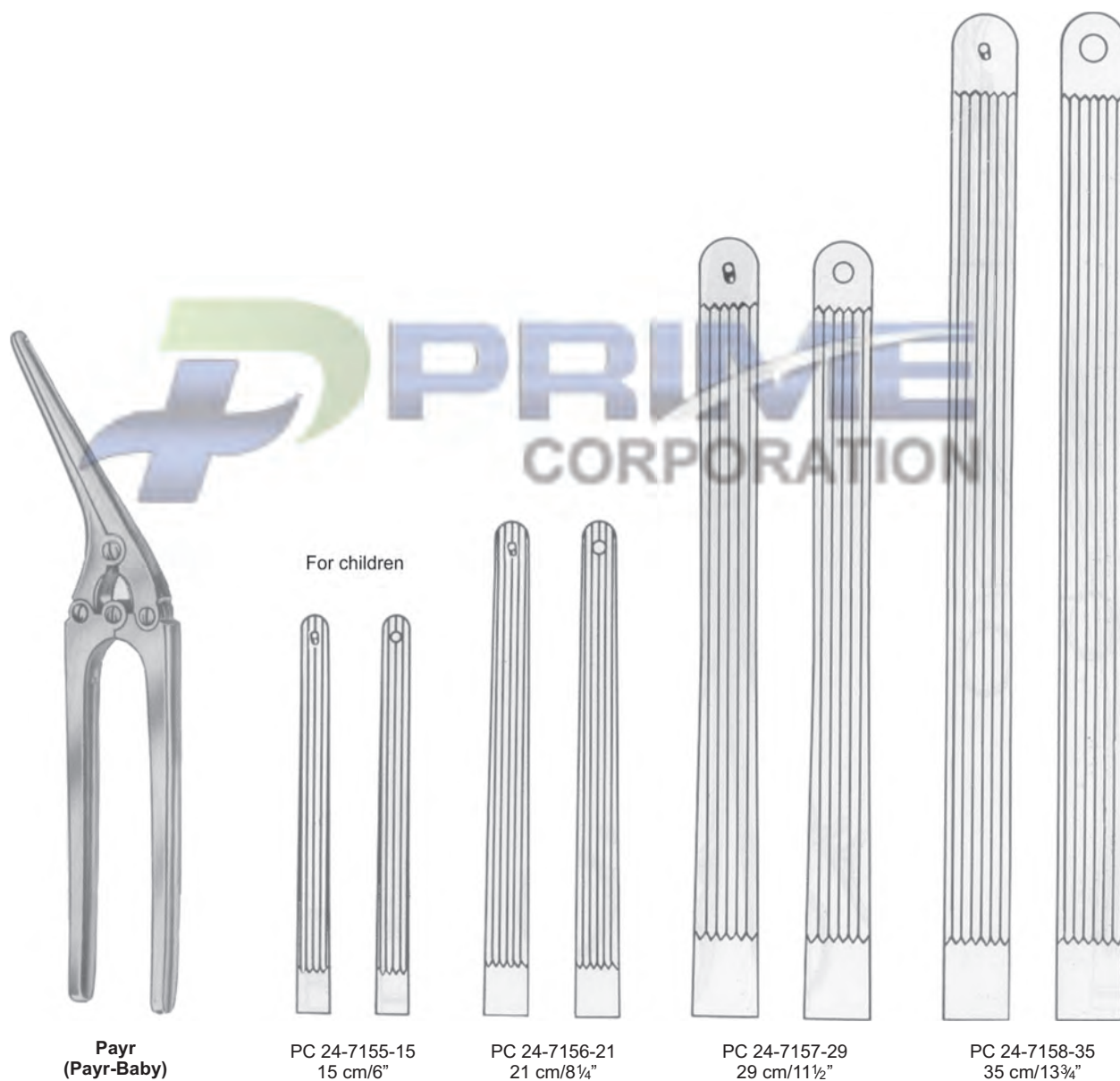

- Intestinal Clamps Forceps ● EN
- Darmklemmen ● DE
- Pinzas-clamps intestinales ● ES

Twin Clamps Forceps

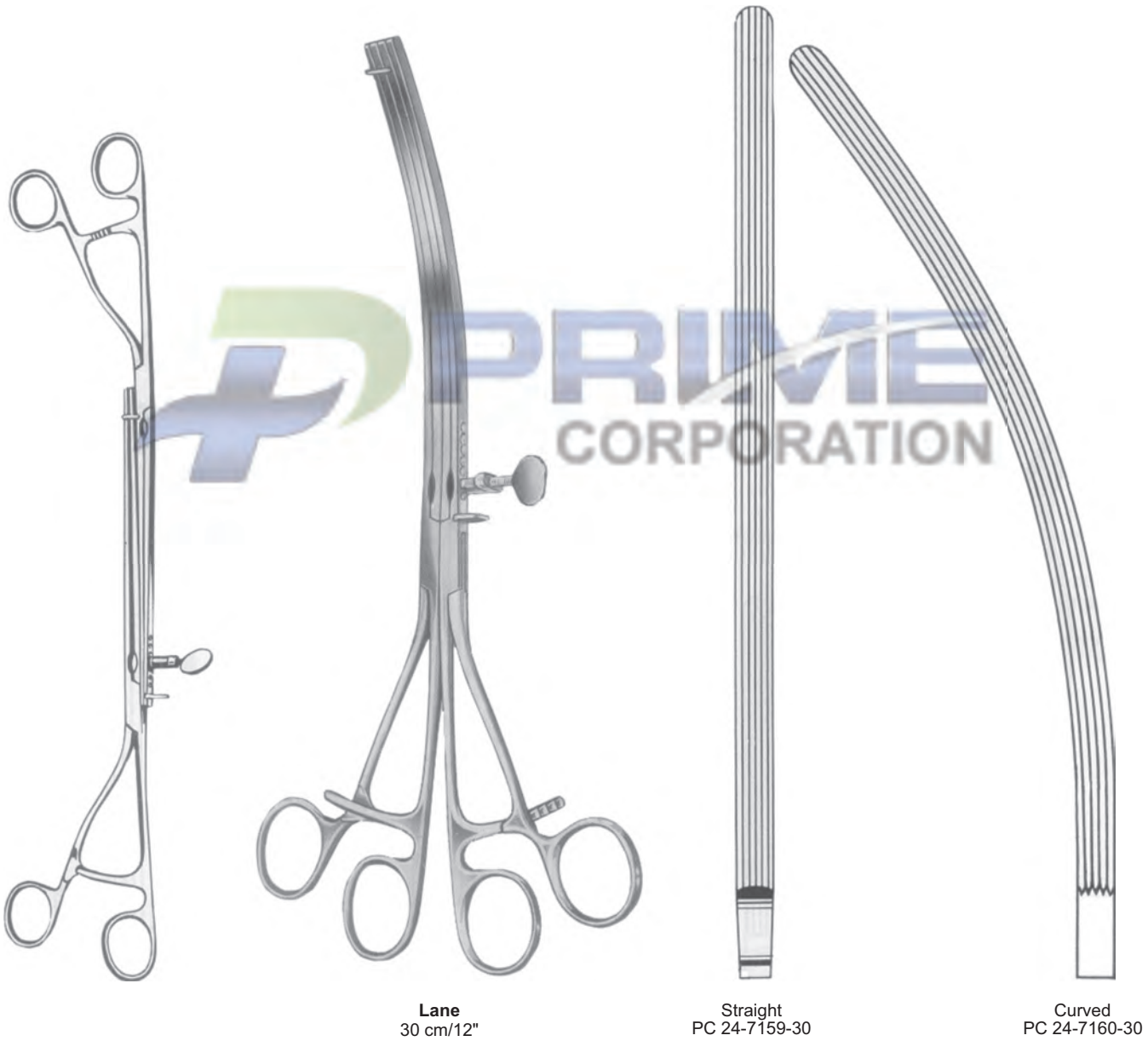

- EN —● Stomach Clamps Forceps
- DE —● Magenklappen
- ES —● Pinzas-clamps estomacales

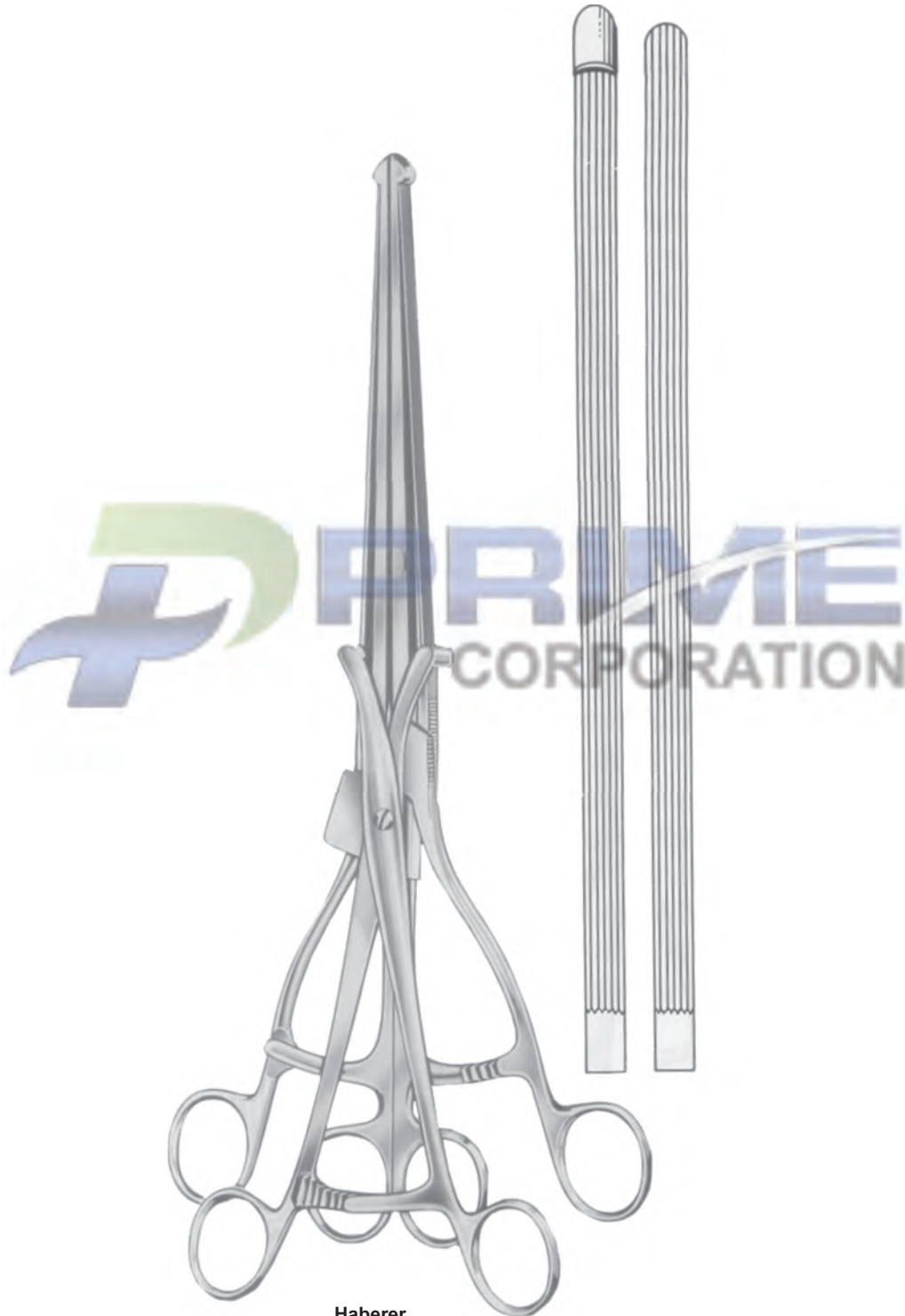

**Haberer**  
PC 24-7161-36  
36 cm/14"

Rectal Specula ●— EN  
 Mastdarm-Spekule ●— DE  
 Especulos rectales ●— ES





- EN —● Proctoscopes  
 DE —● Proktoskope  
 ES —● Proctoscopios



**KELLY**  
 PC 24-7169-01 21mm Ø x 50mm  
 PC 24-7169-02 27mm Ø x 50mm

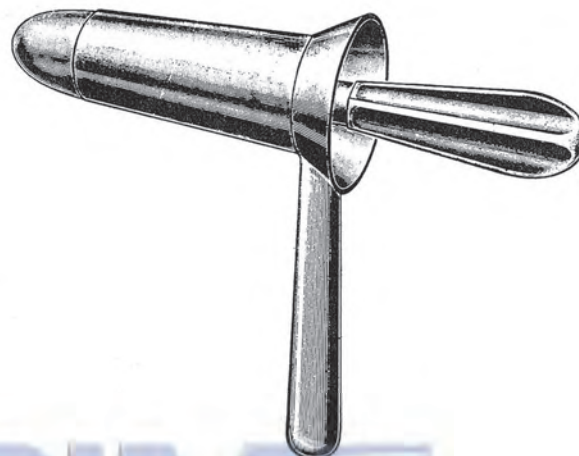

**KELLY**  
 PC 24-7170-01 25mm Ø x 64mm  
 PC 24-7170-02 22mm Ø x 35mm

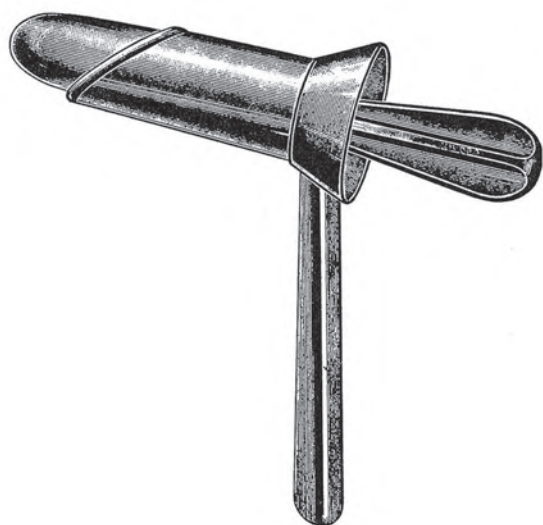

**GRAEME-ANDERSON**  
 PC 24-7171-00  
 24mm Ø x 64mm



**GABRIEL**  
 PC 24-7172-01 24mm Ø x 64mm  
 PC 24-7172-02 19mm Ø x 49mm



Proctoscopes, Anoscope    ● — EN  
 Proktoskope, Anoskop    ● — DE  
 Proctoscopia y anoscopia   ● — ES



**KELLY**  
 PC 24-7173-01 22mm Ø x 50mm  
 PC 24-7173-02 22mm Ø x 100mm  
 PC 24-7173-03 22mm Ø x 140mm  
 PC 24-7173-04 22mm Ø x 200mm

**IVES-FANSLER**  
 PC 24-7174-15  
 22mm Ø



**HIRSCHMANN**  
 PC 24-7175-01 16mm Ø x 65mm  
 PC 24-7175-02 19mm Ø x 65mm  
 PC 24-7175-03 22mm Ø x 65mm



**KELLY**  
 PC 24-7176-01 22mm Ø x 50mm  
 PC 24-7176-02 22mm Ø x 100mm  
 PC 24-7176-03 22mm Ø x 140mm

- EN —● Anusscopes, Proctoscopes and Sphincteroscopes  
 DE —● Sphinkteroskope, Anuskope, Proktoskope  
 ES —● Esfinteroscopios, Anoscopios, Proctoscopios

**MOD. MARTIN**

PC 24-7177-01 22mm Ø X 50mm  
 PC 24-7177-02 22mm Ø X 75mm  
 PC 24-7177-03 22mm Ø X 100mm

**NEWMAN**

PC 24-7178-01 16mm Ø X 63mm  
 PC 24-7178-02 19mm Ø X 63mm  
 PC 24-7178-03 23mm Ø X 63mm

**BENSAUDE**

PC 24-7179-01 19mmØ X 70mm  
 PC 24-7179-02 22mmØ X 70mm

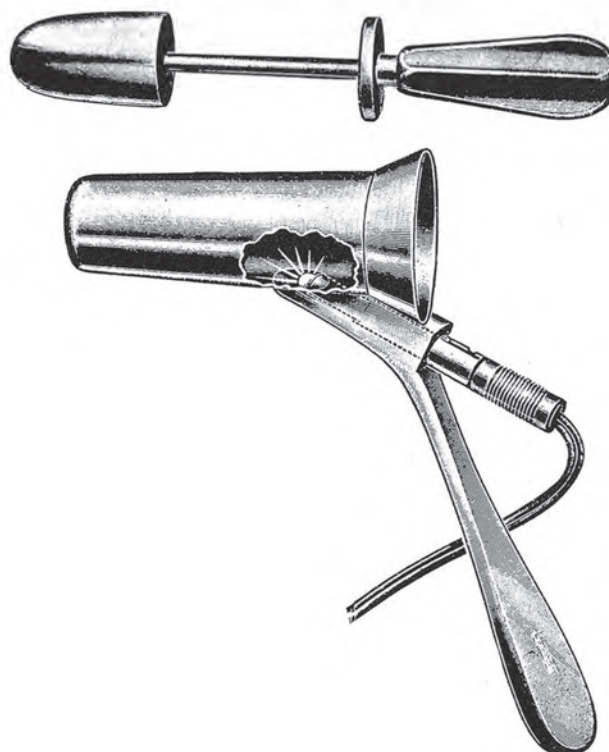

**NAUNTON-MORGAN**

PC 24-7180-00  
 22mmØ X 70mm

Rectal Specula, Anal Retractors ●— EN  
 Mastdarm-Spekule,-Spreizer-Analspreizer ●— DE  
 Especulos rectales ●— ES

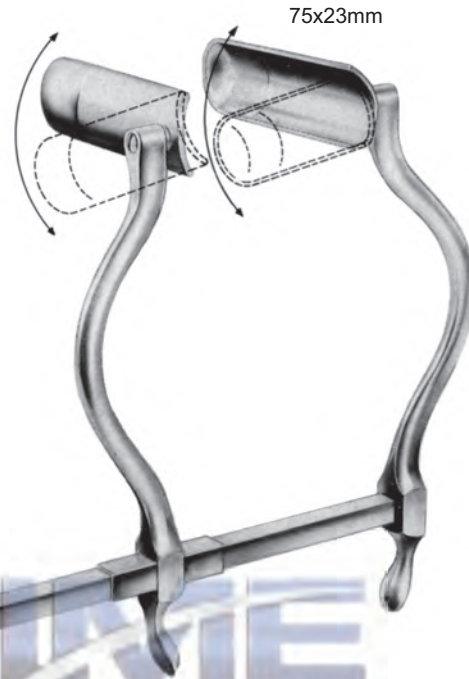

**BARR**  
 PC 24-7181-17  
 17.0cm



**SMITH-BUIE**  
 PC 24-7182-15  
 15.0cm



**ALAN PARKS**  
 13.5cm  
 PC 24-7183-00 complete  
 PC 24-7183-04 centre blade  
 PC 24-7183-13 frame only



PC 24-7183-01  
 72mm



PC 24-7183-02  
 90mm



PC 24-7183-03  
 94mm

- EN —● Rectal Specula and Probes
- DE —● Mastdarm-Specula und Anal Sonden
- ES —● Espéculas rectales y sondas



**CZERNY**  
22.0cm  
PC 24-7184-22  
25x115mm

**SAWYER**  
23.0cm  
PC 24-7185-01 65x22mm  
PC 24-7185-02 75x28mm  
PC 24-7185-03 90x38mm

**FERGUSON-MOON**  
21.0cm  
PC 24-7186-01 65x22mm  
PC 24-7186-02 75x28mm

**BUIE**  
13.5cm  
PC 24-7187-13 light  
PC 24-7188-13 heavy

**LARRY**  
PC 24-7189-18  
18.0cm

**ROSER**  
PC 24-7190-17  
17.0cm

**PRATT**  
22.0cm

PC 24-7191-01

PC 24-7191-02

PC 24-7191-03

**BARR**  
PC 24-7192-23  
23.0cm

**BARR**  
PC 24-7193-14  
14.0cm



Rectal and Fistula Probes ● EN  
 Rectal und Fistelsonden ● DE  
 Rectal y la fistula sondas ● ES

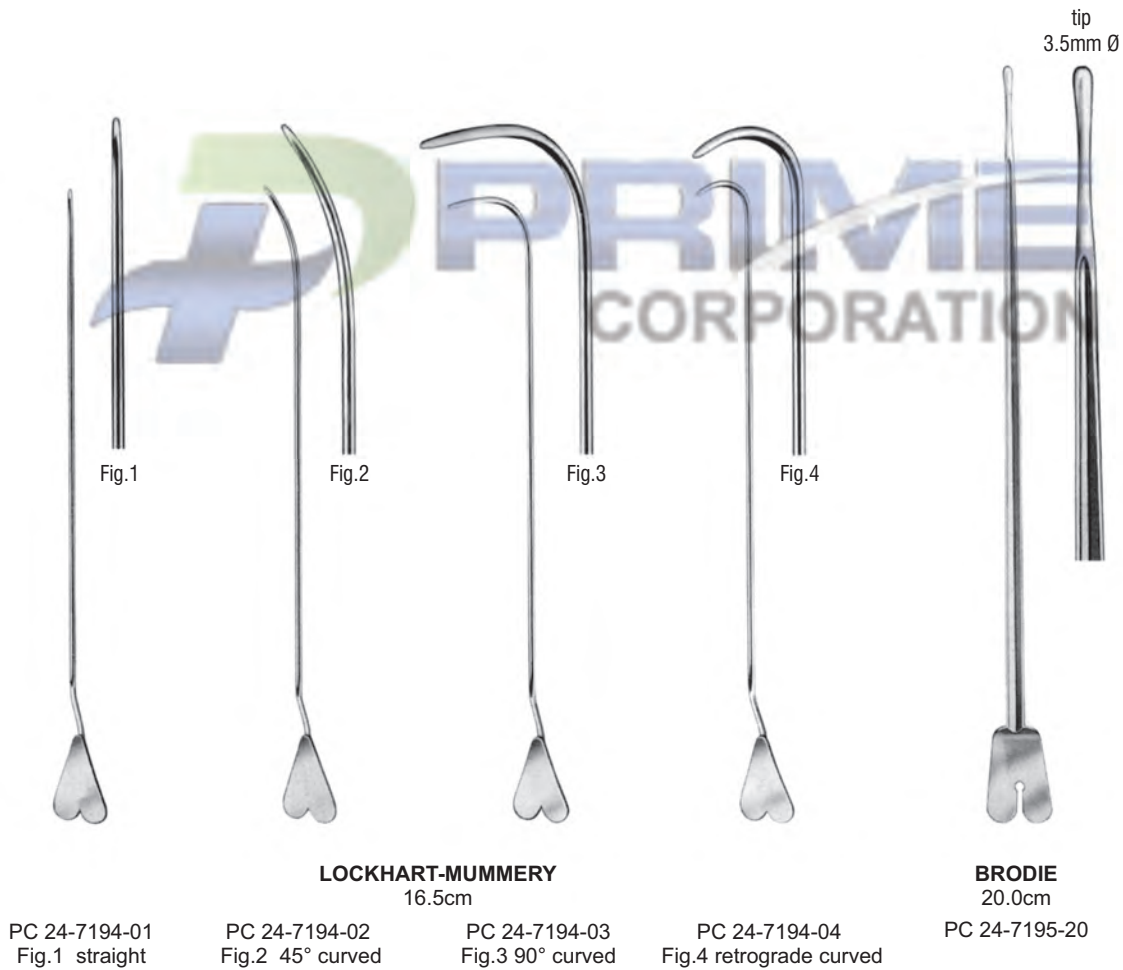



- EN —● Pelvis Retractors
- DE —● Pelvishaken
- ES —● Retractores de pelvis

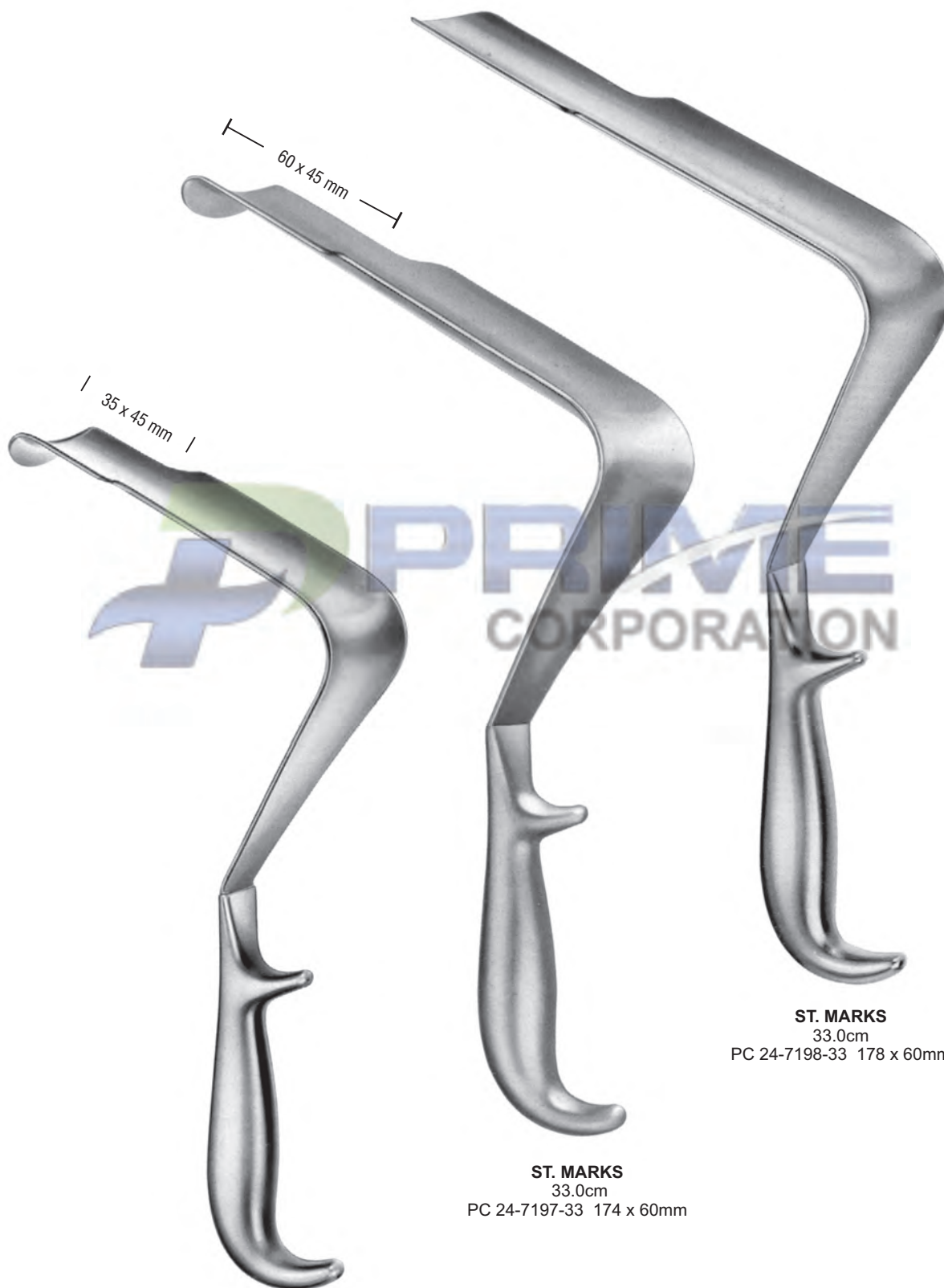

**ST. MARKS**  
29.0cm  
PC 24-7196-29 124x60mm

**ST. MARKS**  
33.0cm  
PC 24-7197-33 174 x 60mm

**ST. MARKS**  
33.0cm  
PC 24-7198-33 178 x 60mm

- Haemorrhoidal Ligator ●— EN
- Hamorrhoidal-Ligator ●— DE
- Hemorroidales ligaduras ●— ES

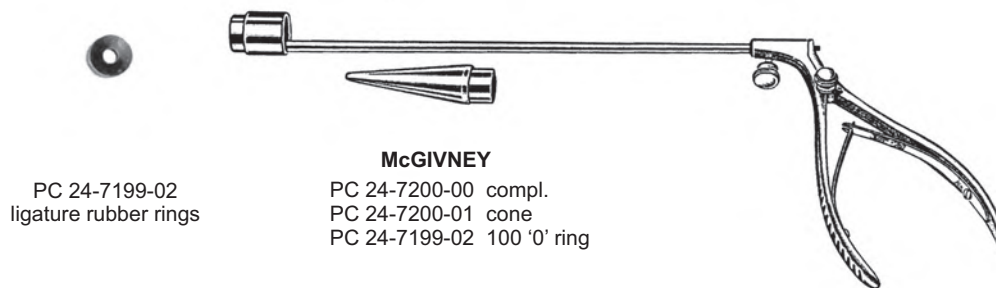

PC 24-7199-02  
ligature rubber rings

**McGIVNEY**  
PC 24-7200-00 compl.  
PC 24-7200-01 cone  
PC 24-7199-02 100 '0' ring

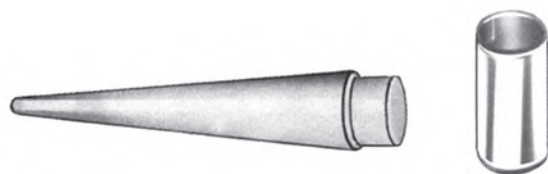

Loading Cone only PC 24-7201-01      Suction Head  
PC 24-7201-11 10x11mm  
PC 24-7201-16 10x16mm



**McGIVNEY**  
PC 24-7202-18  
18.5cm



18.5cm  
PC 24-7203-00 Set  
PC 24-7201-01 Cone  
PC 24-7201-11 Suction Head  
PC 24-7201-16 Suction Head  
PC 24-7199-02 100 '0' ring



**RUDD**  
PC 24-7204-31 31.5cm  
PC 24-7201-01 cone  
PC 24-7199-02 100 '0' ring

- EN —● Rectal Biopsy Specimen Forceps
- DE —● Mastdarm-Biopsiezange,
- ES —● Pinza sacabocado para biopsia rectal

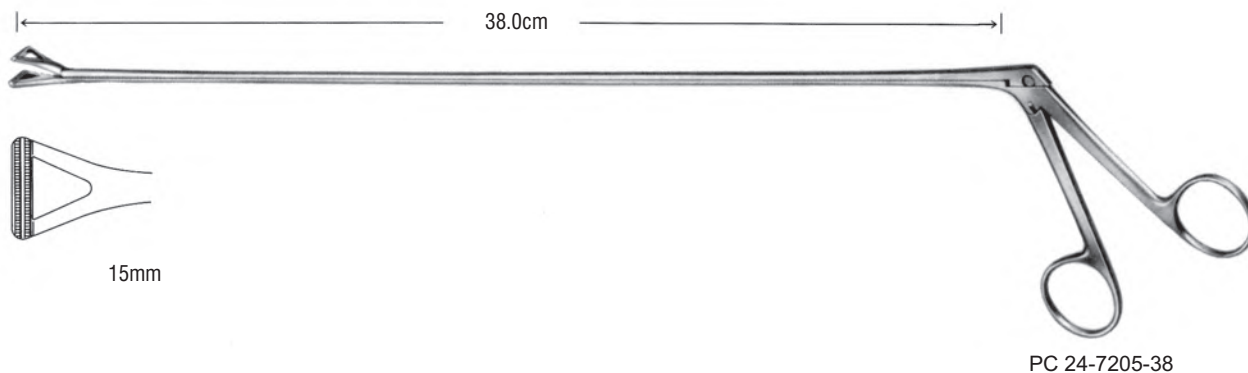

**HEYWOOD-SMITH**  
PC 24-7206-21  
21.0cm

**HEYWOOD-SMITH**  
PC 24-7207-20  
20.0cm

**LUER**  
PC 24-7208-24  
24.5cm

Rectal Biopsy Forceps ● EN  
 Mastdarm-Biopsiezange ● DE  
 Pinzas sacabocado p / biopsia rectal ligaduras ● ES

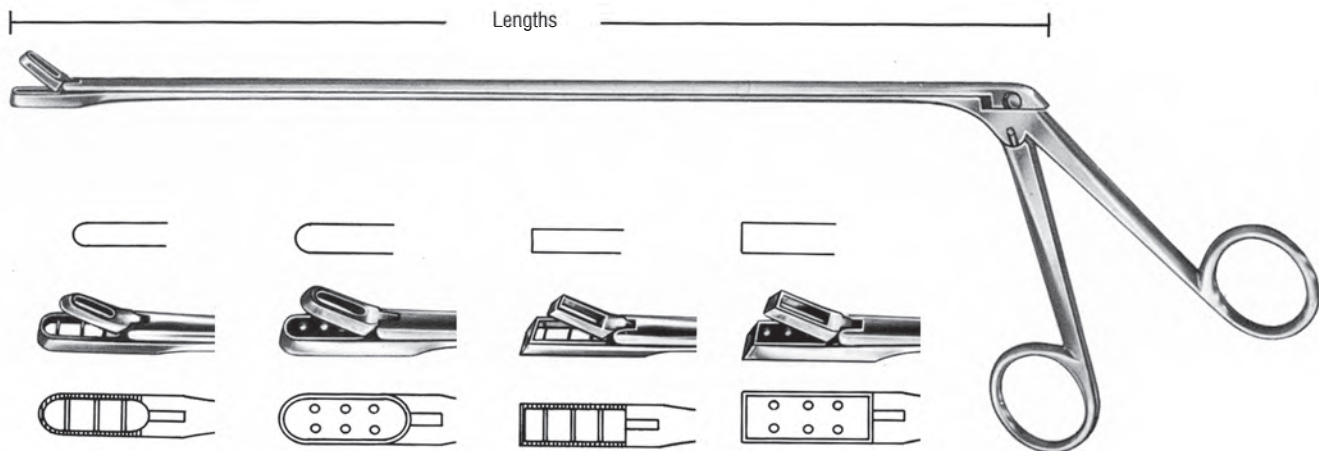
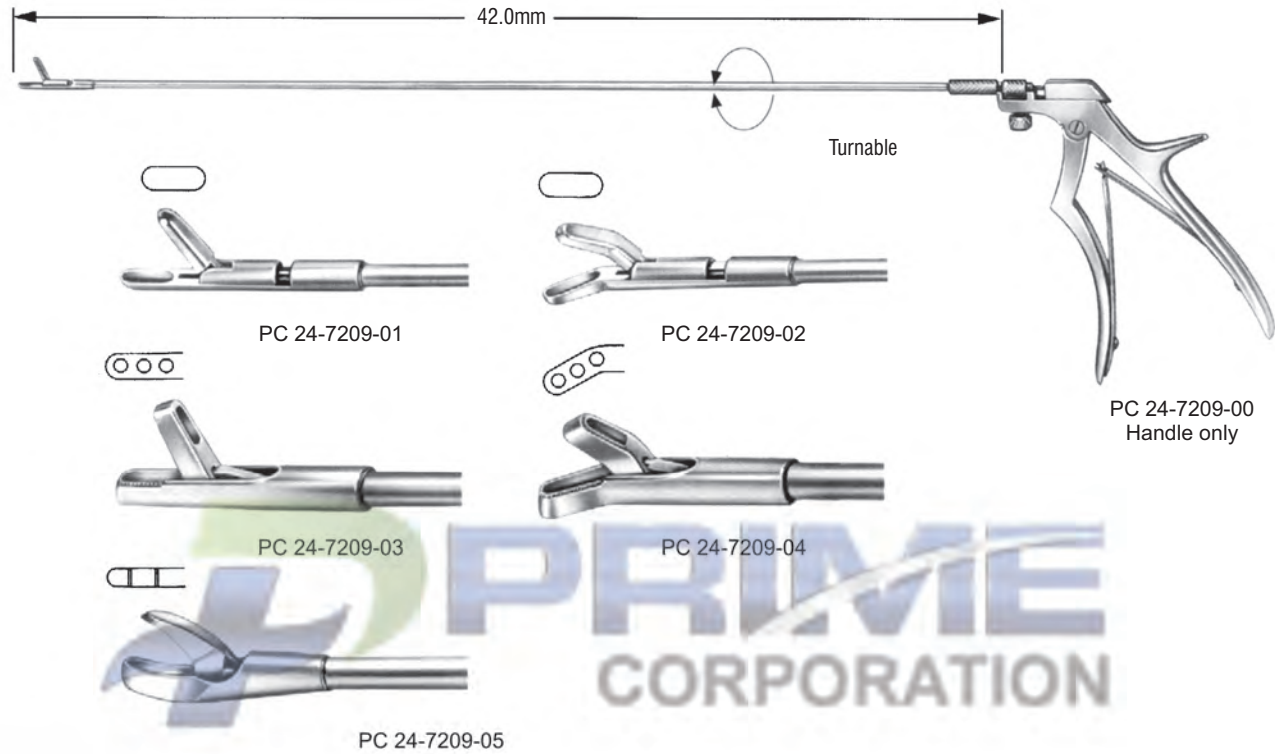

L/shaft	PC 24-7210-28	PC 24-7211-28	PC 24-7212-28	PC 24-7213-28
28.0cm	PC 24-7210-28	PC 24-7211-28	PC 24-7212-28	PC 24-7213-28
35.0cm	PC 24-7210-35	PC 24-7211-35	PC 24-7212-35	PC 24-7213-35
42.0cm	PC 24-7210-42	PC 24-7211-42	PC 24-7212-42	PC 24-7213-42



- EN —● Cotton Carrier For Rectoscope, Cotton Carriers  
 DE —● Swattatrager Fur Rektoskope, Baumwollenboten  
 ES —● Posta algodón para rectoscopios, portadores de algodón

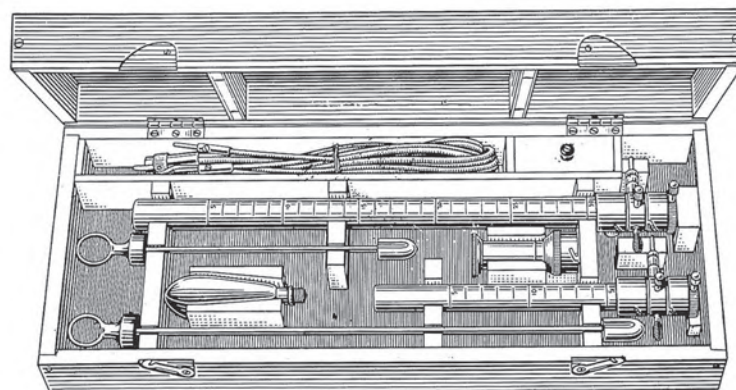

**LLOYDS-DAVIES**  
PC 24-7214-00 complete

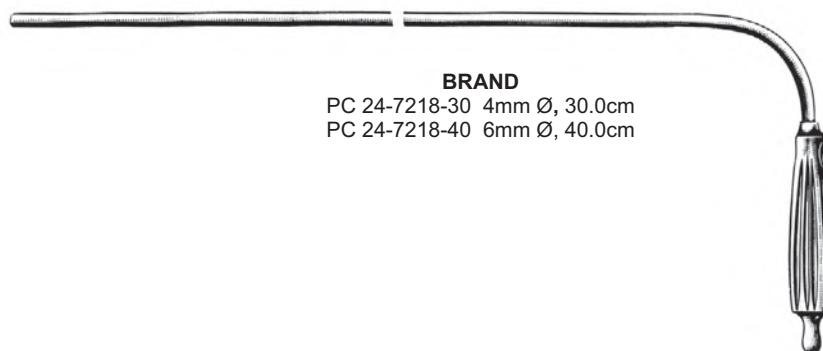
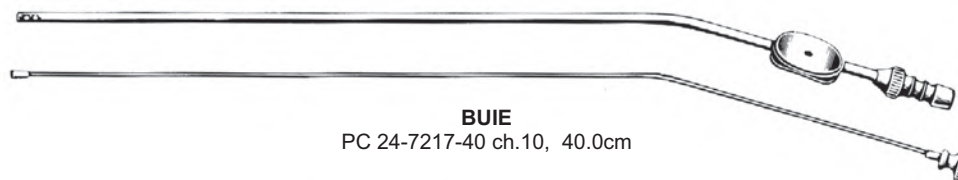
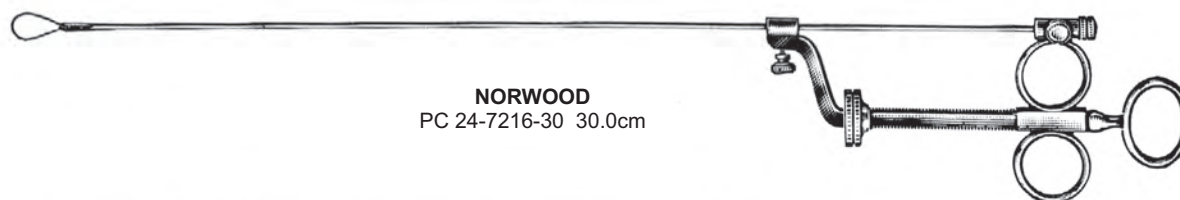



**EN** Kidney, Liver, Gall Stone, Urology

**DE** Niere, Leber, Galle, Urologie

**ES** Riñón, Hígado, Bilis, Urología

**Page 620 to 638**



- EN —● Kidney Pedicle Clamp Forceps
- DE —● Kidney Gestielte Klammerzange
- ES —● Pinzas de riñón Clamp pediculares

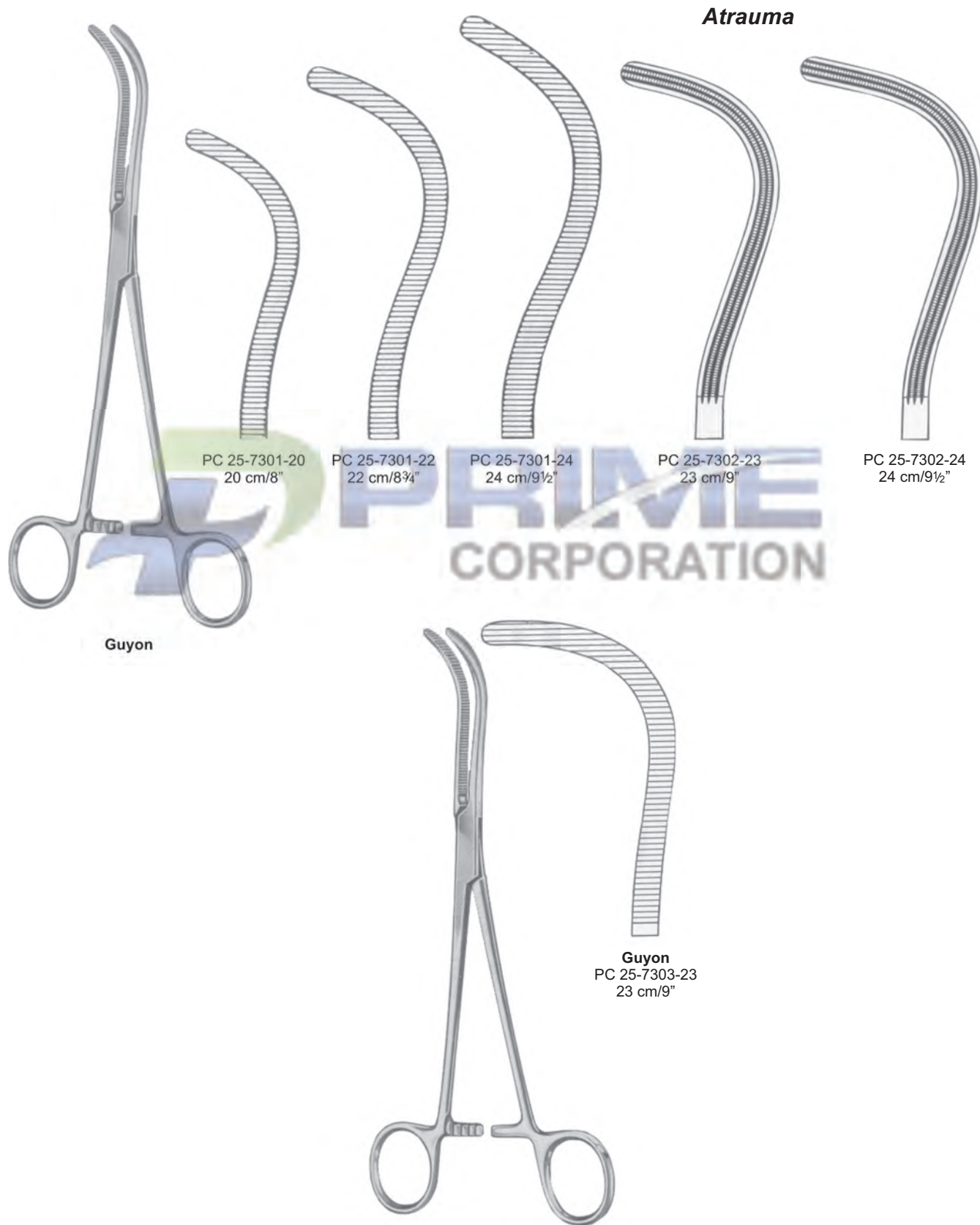

- Kidney Pedicle Clamp Forceps ●— EN
- Kidney Gestielte Klammerzange ●— DE
- Pinzas de riñón Clamp pediculares ●— ES

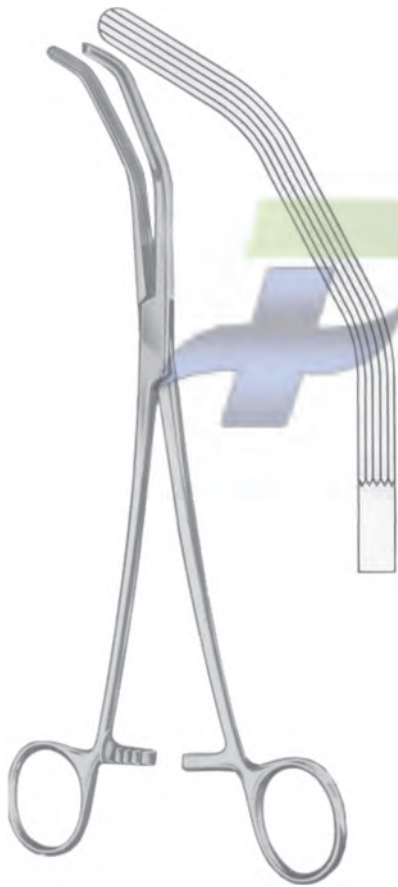

**Herrick**  
PC 25-7304-23  
23 cm/9"

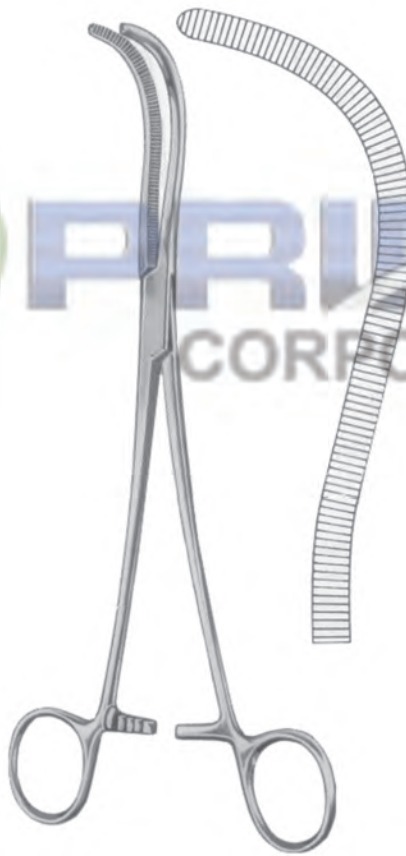

**Mayo-Guyon**  
PC 25-7305-23  
23 cm/9"



**Stille**  
PC 25-7306-23  
23 cm/9"

- EN —● Nephrostomy Forceps and Kidney Stones
- DE —● Nierenfistelzangen, Gallensteinzangen
- ES —● Pinza para nefrostomía, pinzas para cálculos biliares

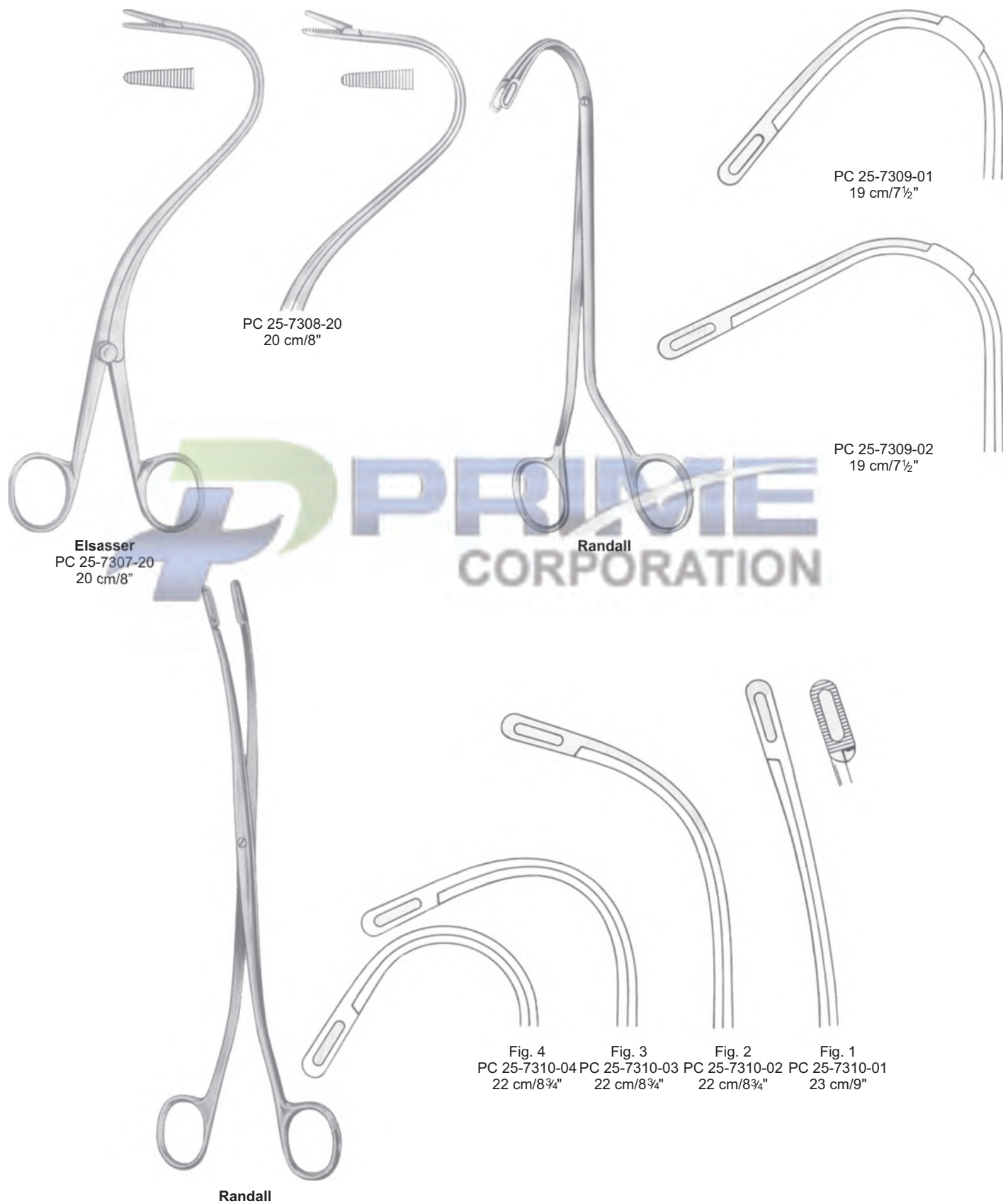

- Gall Duct Forceps ●— EN
- Gall Duct Zange ●— DE
- Pinzas conducto biliar ●— ES

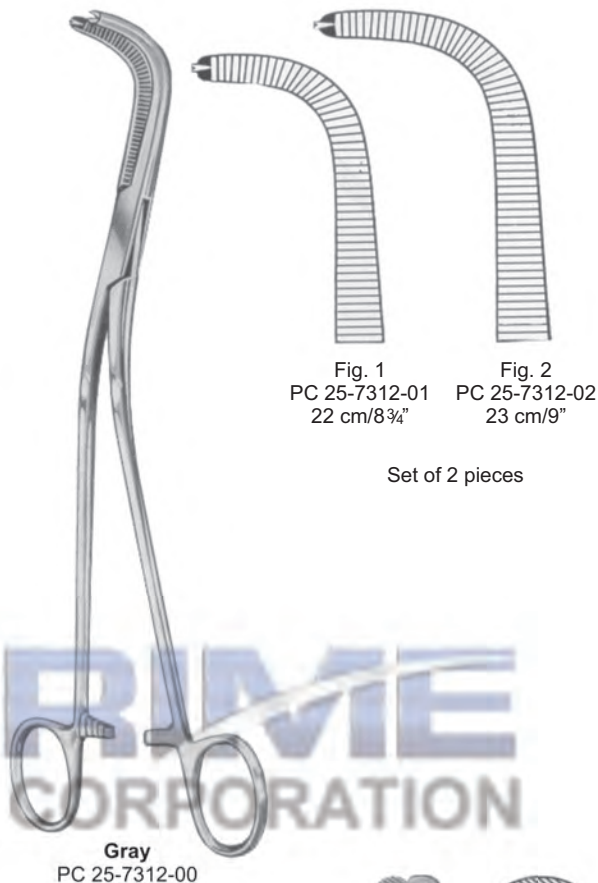
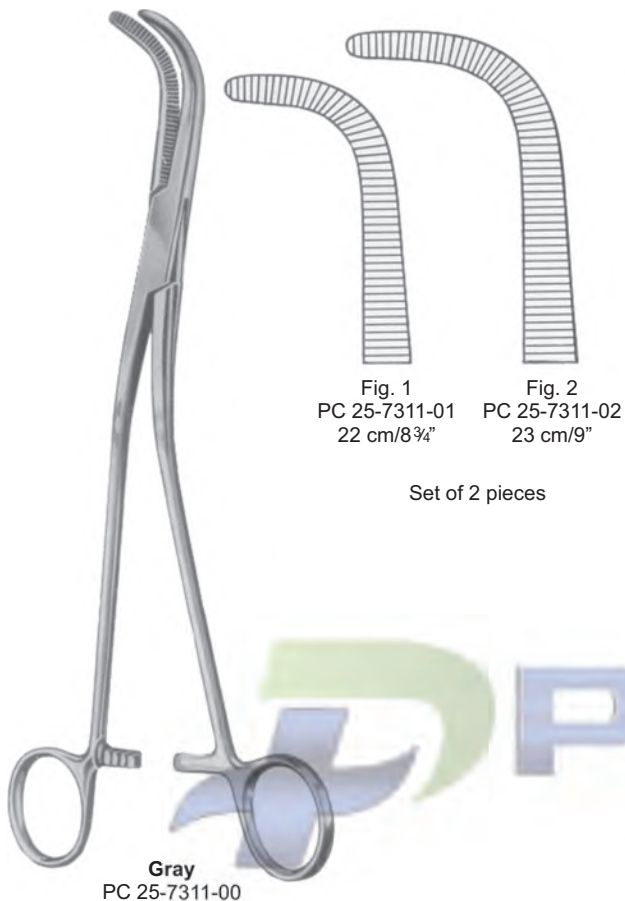



- EN —● Gall Stone Forceps
- DE —● Gallensteinzngen
- ES —● Pinzas para cálculo hiliares

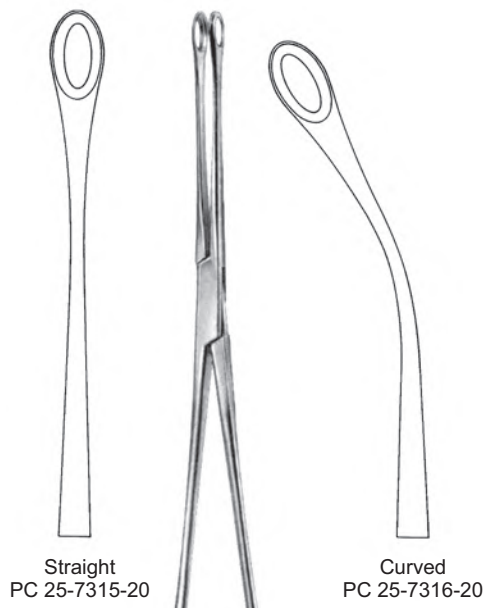

Straight  
PC 25-7315-20

Curved  
PC 25-7316-20



Straight  
PC 25-7317-20

Mayo-Blake  
20 cm/8"



Curved  
PC 25-7318-20

Mayo-Blake  
20 cm/8"



Blake  
20 cm/8"

Czerny  
PC 25-7319-24  
24.5 cm/9¾"

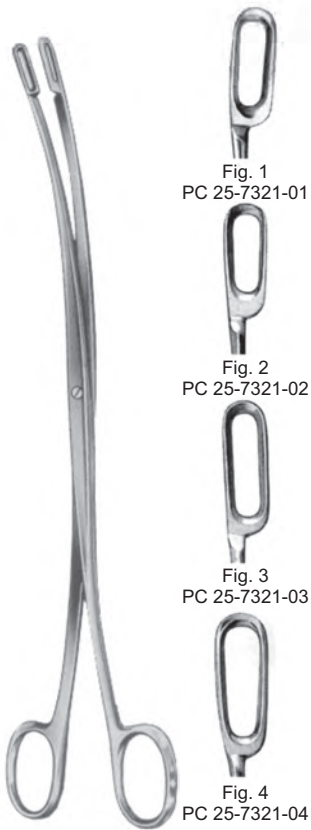

Fig. 1  
PC 25-7321-01

Fig. 2  
PC 25-7321-02

Fig. 3  
PC 25-7321-03

Fig. 4  
PC 25-7321-04

Gall Stone Probes and Bile Duct Dilators ●— EN  
 Gallensteinsonden, Gallenkanal-Dilatoren ●— DE  
 Las sondas del cálculo biliar y ductos biliares dilatadores ●— ES

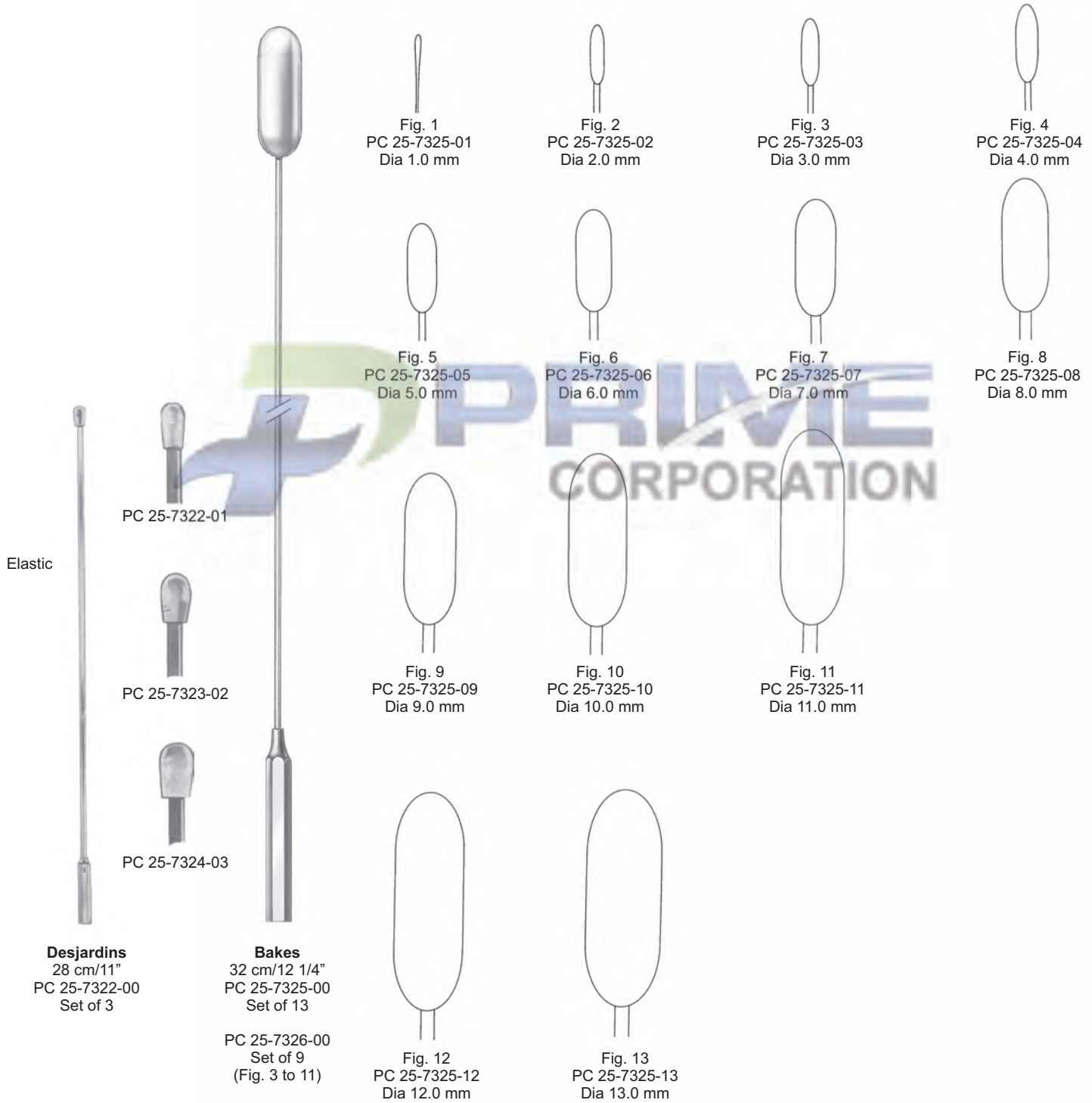

- EN —● Gall Stone Scoops
- DE —● Gallensteinlöffel
- ES —● Cucharillas para coger cálculos biliares

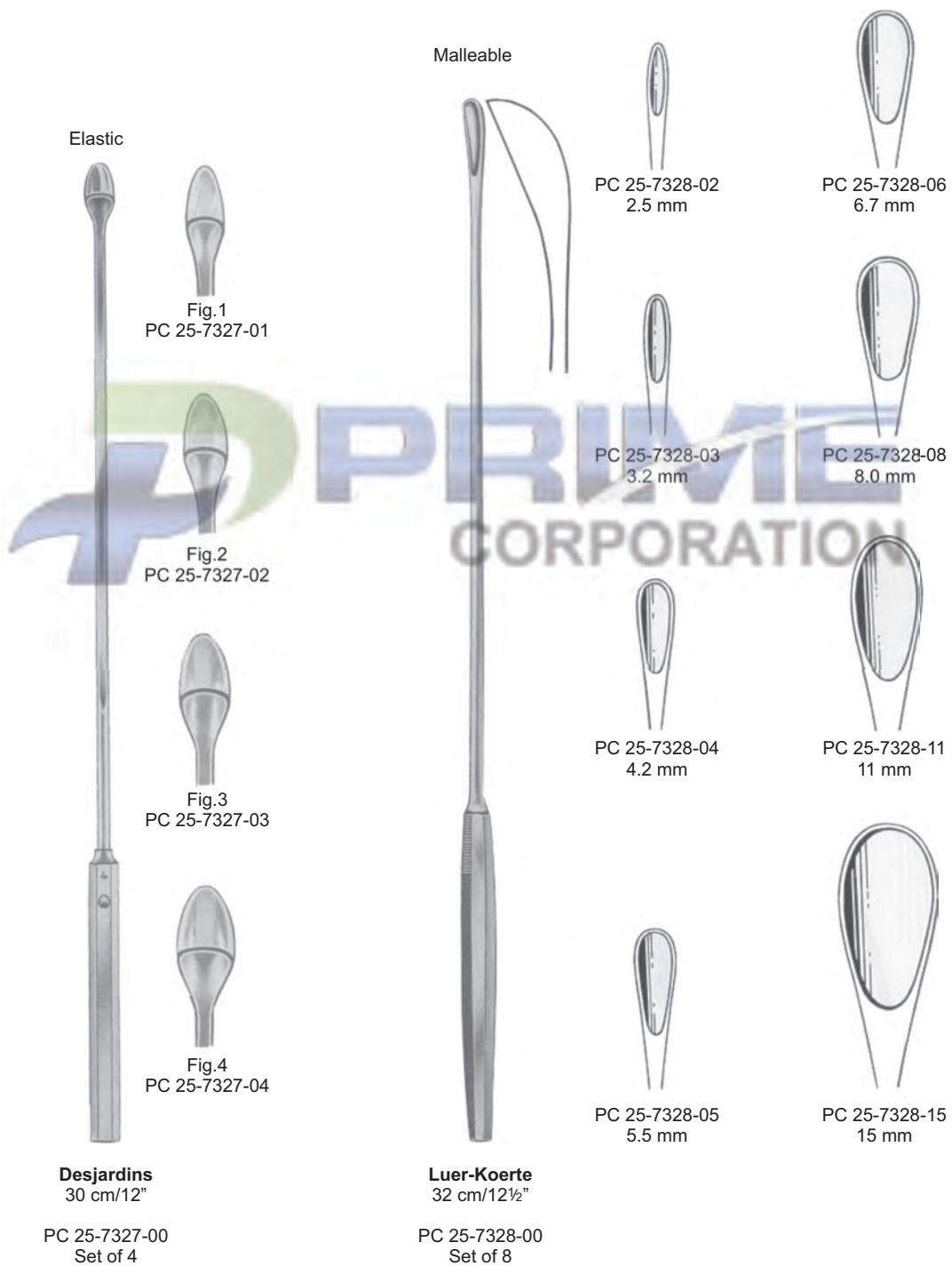

Gall Stone Scoops ●— EN  
 Gallensteinlöffel ●— DE  
 Cucharillas para coger cálculos biliares ●— ES

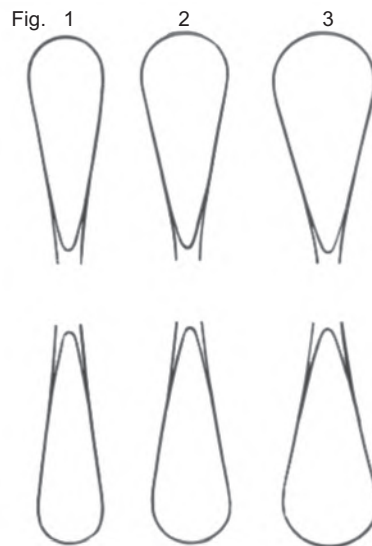

**Mayo**  
PC 25-7329-28  
28 cm/11"



**Mayo**  
26.5 cm/10½"



**Moore**  
26-8506-28  
28 cm/11"

Fig.  
1 PC 25-7331-01  
2 PC 25-7331-02  
3 PC 25-7331-03



**Fergusson**  
24 cm/9½"

- EN —● Prostatic Retractors, Prostatectomy instruments
- DE —● Prostatachaken, Instrumente für prostata-operationen
- ES —● Separadores para la próstata, instrumentos para prostatectomía



**Young**  
PC 25-7332-22  
22 cm/8¾"



**Young**  
PC 25-7333-21  
21 cm/8¼"



**Young**  
PC 25-7334-22  
22 cm/8¾"



**Young**  
PC 25-7335-21  
21 cm/8¼"



**MILLIN**  
PC 25-7336-01  
24.5cm



PC 25-7336-02 23.5cm



PC 25-7336-03 23.0cm

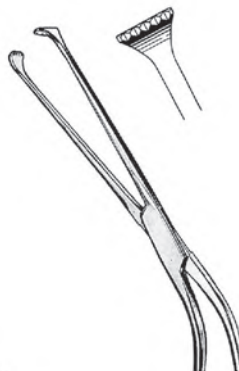

PC 25-7336-04 23.0cm

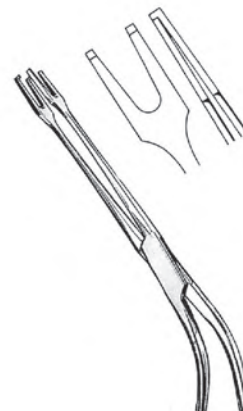

PC 25-7336-05 24.0cm



- Bladder Retractors ● EN
- Gallensteinlöffel ● DE
- Separadores vesicales ● ES



**Millin**  
PC 25-7339-00



**Legueu**  
PC 25-7340-00

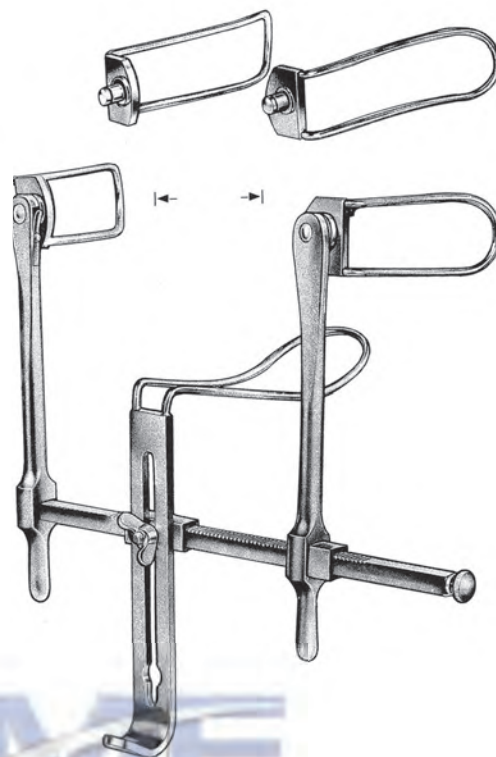

**Gosset**  
PC 25-7341-00

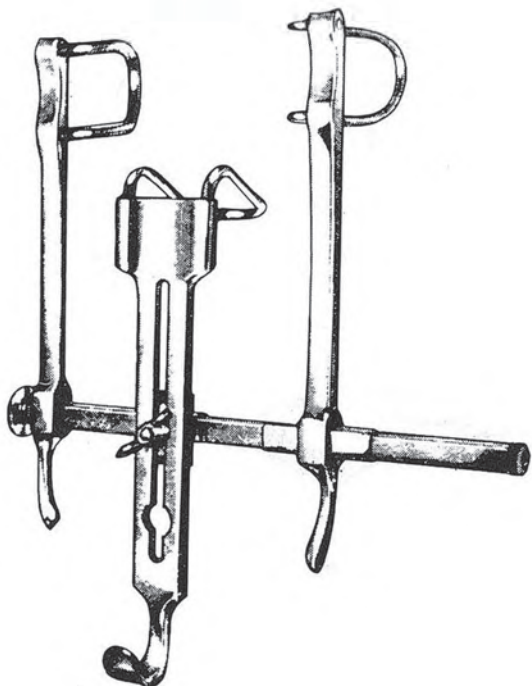

**Pantings**  
PC 25-7342-00

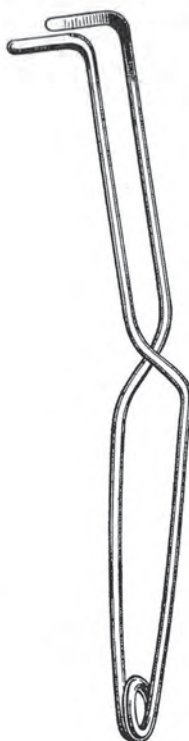

**Millin**  
PC 25-7342-01  
24 cm/9½"

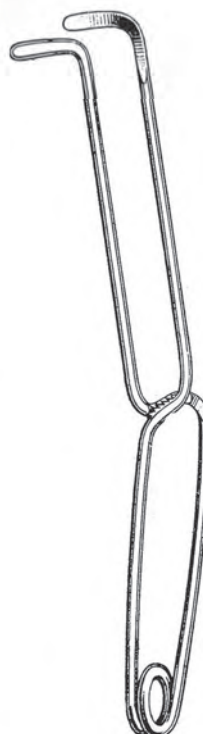

**Millin**  
PC 25-7342-02  
24 cm/9½"



**Millin**  
PC 25-7342-03  
24 cm/9½"

- EN —● Bladder Retractors
- DE —● Blasen-Wundspreizer
- ES —● Separadores vesicales

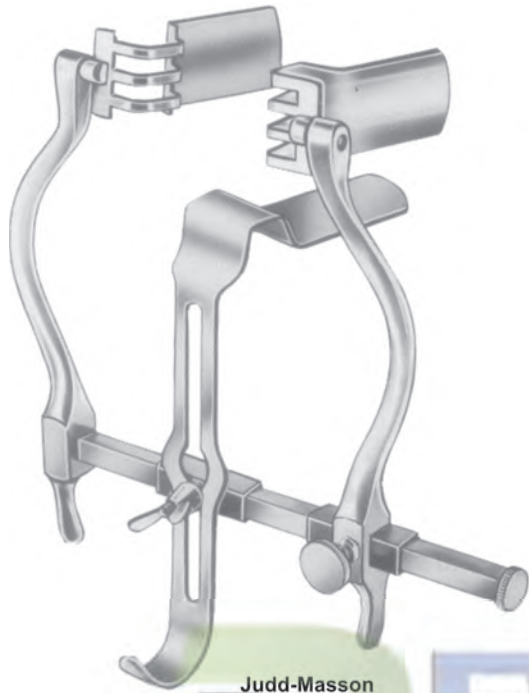

**Judd-Masson**  
PC 25-7343-00

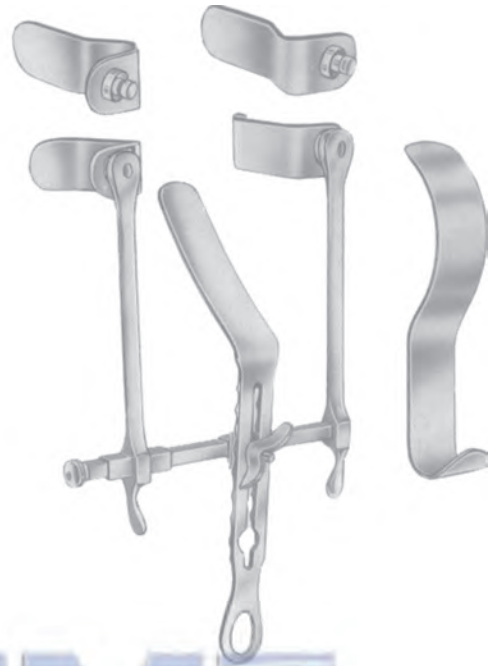

**Thomson-Walker**  
PC 25-7344-00



35 mm

**Legueu**  
PC 25-7345-27  
27 cm/10½"



67 mm

**Kocher**  
PC 25-7345-26  
26 cm/10¼"

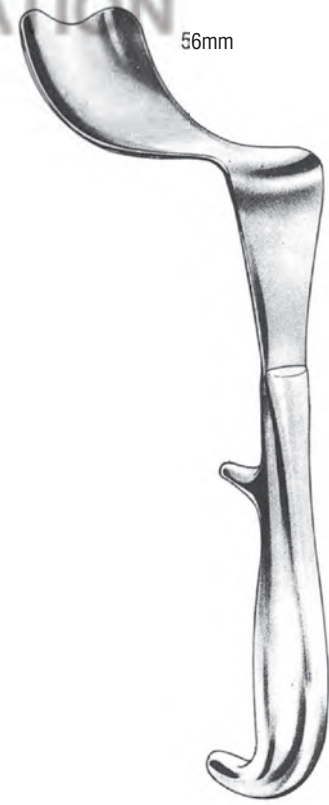

56 mm

**Kocher**  
PC 25-7346-26  
26 cm/10¼"

- Foreign Body Forceps ● EN
- Fremdkorperzangen ● DE
- Pinzas p/cuerpos extraños ● ES



**SACHSE**  
PC 25-7347-12



**MATHIEU**  
PC 25-7348-20 20.0cm  
PC 25-7348-28 28.0cm



**MATHIEU**  
PC 25-7349-20 20.0cm  
PC 25-7349-28 28.0cm

- EN —● Penis Clamp and Lithotomy Forceps  
 DE —● Penisklemmen und Steinzgen  
 ES —● Compresores uretrales y pinzas p/litomia



**STOCKMANN**  
PC 25-7350-08



**ZIESER MEAEUS CLAMP**  
PC 25-7351-10  
10.0cm



**STRAUSS**  
PC 25-7352-11



**THOMSON-WALKER**  
PC 25-7353-00



**LEWKOWITZ**  
PC 25-7354-26  
26.0cm



PC 25-7355-26

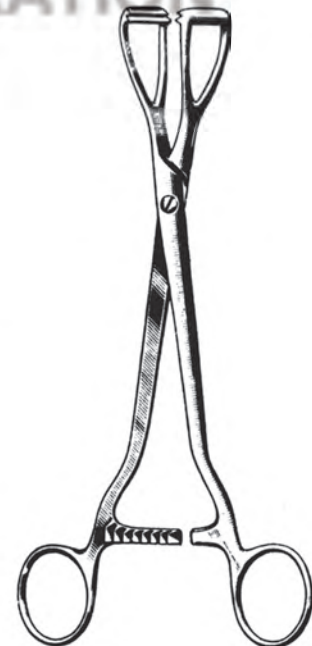

**YOUNG**  
PC 25-7356-20  
20.0cm



Circumcision Instruments ● EN  
 Circumcisions Instrumente ● DE  
 Instrumentos p/circumisión ● ES



**GAMCO**

- PC 25-7357-08 8mm Ø, baby size
- PC 25-7357-11 11mm Ø, child size
- PC 25-7357-13 13mm Ø, child size
- PC 25-7357-16 16mm Ø, adolescent size
- PC 25-7357-21 21mm Ø, adolescent size
- PC 25-7357-26 26mm Ø, men's size
- PC 25-7357-32 32mm Ø, men's size



**WINKELMANN**

- PC 25-7358-12 12mm Ø
- PC 25-7358-16 16mm Ø
- PC 25-7358-20 20mm Ø

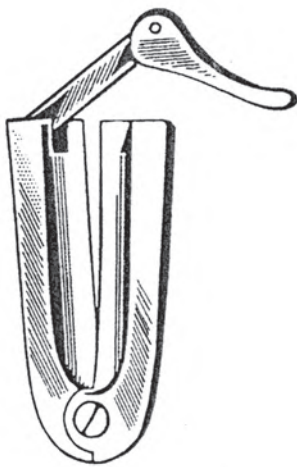

**MOGEN**

PC 25-7359-00  
58.0162.00

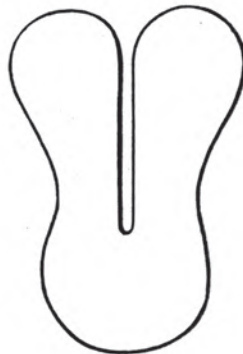

**CIRCUMCISION SHIELD**

PC 25-7360-10  
10.0cm



**CIRCUMCISION PROBE**

PC 25-7361-15  
15.0cm



- EN —● Hernia Directors, Suction Tube, Cord Hook
- DE —● Sonden, Aspirationskanulen, Haken für den sanenstrang
- ES —● Sondas, canulas de aspiracion, gancho/el cordon



**CHILD**  
PC 25-7362-00



**KEY**  
PC 25-7363-00



**TEALE**  
PC 25-7364-00

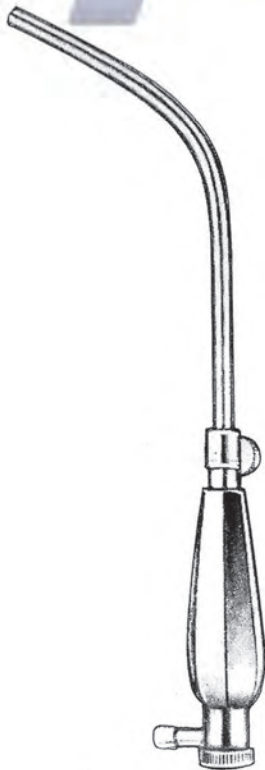

**MILLIN**  
PC 25-7365-00



**CORD HOOK**  
PC 25-7366-16  
16.0cm



**GUTTMANN**  
PC 25-7367-26  
26.0cm

Metal Catheters and Catheter Guide ●— EN  
 Metall Katheter und Katheterspanner ●— DE  
 Sondas metalicas y mandril para sondas ●— ES



PC 25-7373-35  
35.0cm

PC 25-7372-39  
39.0cm

**COXETER**

F.G.	MALE		FEMALE	MALE
	27.0cm	28.0cm		
6	PC 25-7368-06	PC 25-7369-06	PC 25-7370-06	PC 25-7371-06
8	PC 25-7368-08	PC 25-7369-08	PC 25-7370-08	PC 25-7371-08
10	PC 25-7368-10	PC 25-7369-10	PC 25-7370-10	PC 25-7371-10
12	PC 25-7368-12	PC 25-7369-12	PC 25-7370-12	PC 25-7371-12
14	PC 25-7368-14	PC 25-7369-14	PC 25-7370-14	PC 25-7371-14
16	PC 25-7368-16	PC 25-7369-16	PC 25-7370-16	PC 25-7371-16
18	PC 25-7368-18	PC 25-7369-18	PC 25-7370-18	PC 25-7371-18
20	PC 25-7368-20	PC 25-7369-20	PC 25-7370-20	PC 25-7371-20
22	PC 25-7368-22	PC 25-7369-22	PC 25-7370-22	PC 25-7371-22
24	PC 25-7368-24	PC 25-7369-24	PC 25-7370-24	PC 25-7371-24

EN —● Dilating Bougies  
 DE —● Dilationsbonsbougies  
 ES —● Bujias Dilatadoras

**CLUTTON**

set	PC 25-7374-00
F.G.	
06/10	PC 25-7374-06
08/12	PC 25-7374-08
10/14	PC 25-7374-10
12/16	PC 25-7374-12
14/18	PC 25-7374-14
16/20	PC 25-7374-16
18/22	PC 25-7374-18
20/24	PC 25-7374-20
22/26	PC 25-7374-22
24/28	PC 25-7374-24
26/30	PC 25-7374-26
28/32	PC 25-7374-28

**LISTER**

set	PC 25-7375-00
F.G.	
00/1	PC 25-7375-01
0/2	PC 25-7375-02
1/3	PC 25-7375-03
1/4	PC 25-7375-04
2/5	PC 25-7375-05
3/6	PC 25-7375-06
4/7	PC 25-7375-07
5/8	PC 25-7375-08
6/9	PC 25-7375-09
7/10	PC 25-7375-10
8/11	PC 25-7375-11
9/12	PC 25-7375-12
10/13	PC 25-7375-13
11/14	PC 25-7375-14
12/15	PC 25-7375-15
13/16	PC 25-7375-16
14/17	PC 25-7375-17
15/18	PC 25-7375-18

**F.G.**

06	PC 25-7376-06
08	PC 25-7376-08
10	PC 25-7376-10
12	PC 25-7376-12
14	PC 25-7376-14
16	PC 25-7376-16

**WHEELHOUSE**

PC 25-7377-00

Dilating Bougies ●— EN  
 Dilationsbonsbougies ●— DE  
 Bujias dilatadoras ●— ES



	<b>VAN BUREN</b> PC 25-7378-00 set No. 8-36	<b>GUYON</b> PC 25-7379-00 set No. 10-30	<b>GUYON</b> PC 25-7380-00 set No. 10-30	<b>DITTEL</b> PC 25-7381-00 set No.10-30	<b>DITTEL</b> PC 25-7382-00 set No.8-30
(French)					
8	PC 25-7378-08				PC 25-7382-08
9					PC 25-7382-09
10	PC 25-7378-10	PC 25-7379-10	PC 25-7380-10	PC 25-7381-10	PC 25-7382-10
11		PC 25-7379-11	PC 25-7380-11	PC 25-7381-11	PC 25-7382-11
12	PC 25-7378-12	PC 25-7379-12	PC 25-7380-12	PC 25-7381-12	PC 25-7382-12
13		PC 25-7379-13	PC 25-7380-13	PC 25-7381-13	PC 25-7382-13
14	PC 25-7378-14	PC 25-7379-14	PC 25-7380-14	PC 25-7381-14	PC 25-7382-14
15		PC 25-7379-15	PC 25-7380-15	PC 25-7381-15	PC 25-7382-15
16	PC 25-7378-16	PC 25-7379-16	PC 25-7380-16	PC 25-7381-16	PC 25-7382-16
17		PC 25-7379-17	PC 25-7380-17	PC 25-7381-17	PC 25-7382-17
18	PC 25-7378-18	PC 25-7379-18	PC 25-7380-18	PC 25-7381-18	PC 25-7382-18
19		PC 25-7379-19	PC 25-7380-19	PC 25-7381-19	PC 25-7382-19
20	PC 25-7378-20	PC 25-7379-20	PC 25-7380-20	PC 25-7381-20	PC 25-7382-20
21		PC 25-7379-21	PC 25-7380-21	PC 25-7381-21	PC 25-7382-21
22	PC 25-7378-22	PC 25-7379-22	PC 25-7380-22	PC 25-7381-22	PC 25-7382-22
23		PC 25-7379-23	PC 25-7380-23	PC 25-7381-23	PC 25-7382-23
24	PC 25-7378-24	PC 25-7379-24	PC 25-7380-24	PC 25-7381-24	PC 25-7382-24
25		PC 25-7379-25	PC 25-7380-25	PC 25-7381-25	PC 25-7382-25
26	PC 25-7378-26	PC 25-7379-26	PC 25-7380-26	PC 25-7381-26	PC 25-7382-26
27		PC 25-7379-27	PC 25-7380-27	PC 25-7381-27	PC 25-7382-27
28	PC 25-7378-28	PC 25-7379-28	PC 25-7380-28	PC 25-7381-28	PC 25-7382-28
29		PC 25-7379-29	PC 25-7380-29	PC 25-7381-29	PC 25-7382-29
30	PC 25-7378-30	PC 25-7379-30	PC 25-7380-30	PC 25-7381-30	PC 25-7382-30
31	PC 25-7378-31				
32	PC 25-7378-32				
33	PC 25-7378-33				
34	PC 25-7378-34				
35	PC 25-7378-35				
36	PC 25-7378-36				

- EN —● Set of Dilating Sounds  
 DE —● Dilatationsbesteck  
 ES —● Juego de bujias dilatadoras

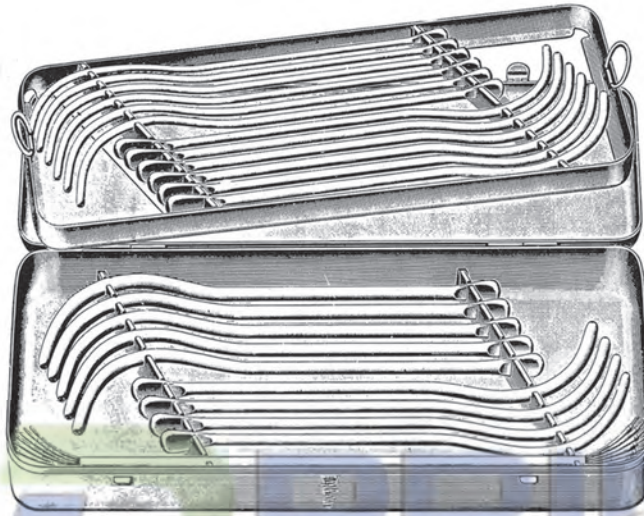

**VAN BUREN**  
 PC 25-7383-00  
 420x175x40 mm  
 set in metal case containing  
 21 bougies



**GUYON**  
 PC 25-7384-00  
 420x175x40mm  
 set in metal case containing  
 21 bougies  
 6 liliform in metal tube



**EN** Dermatology

**DE** Dermatologie

**ES** Dermatología

**Page 639 to 640**

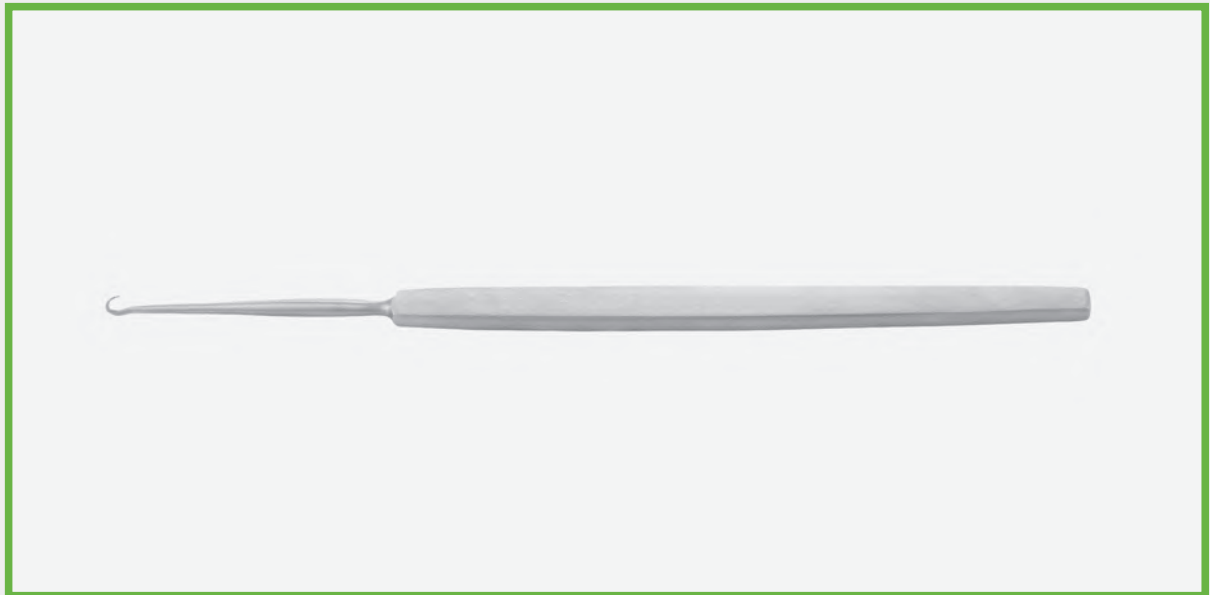

- EN —● Comedone Extractors and Skin Currettes
- DE —● Komedoneninstrumente, Haut-Küretten
- ES —● Sacra-comedones, Curetas piel

Comedone Extractors



**Schamberg**  
PC 26-7450-10  
10 cm/4"

**Unna**  
PC 26-7451-14  
14 cm/5½"

**Unna**  
PC 26-7452-14 PC 26-7453-14  
14 cm/5½" 14 cm/5½"

**Seafield**  
PC 26-7454-10  
10 cm/4"

Skin Currettes

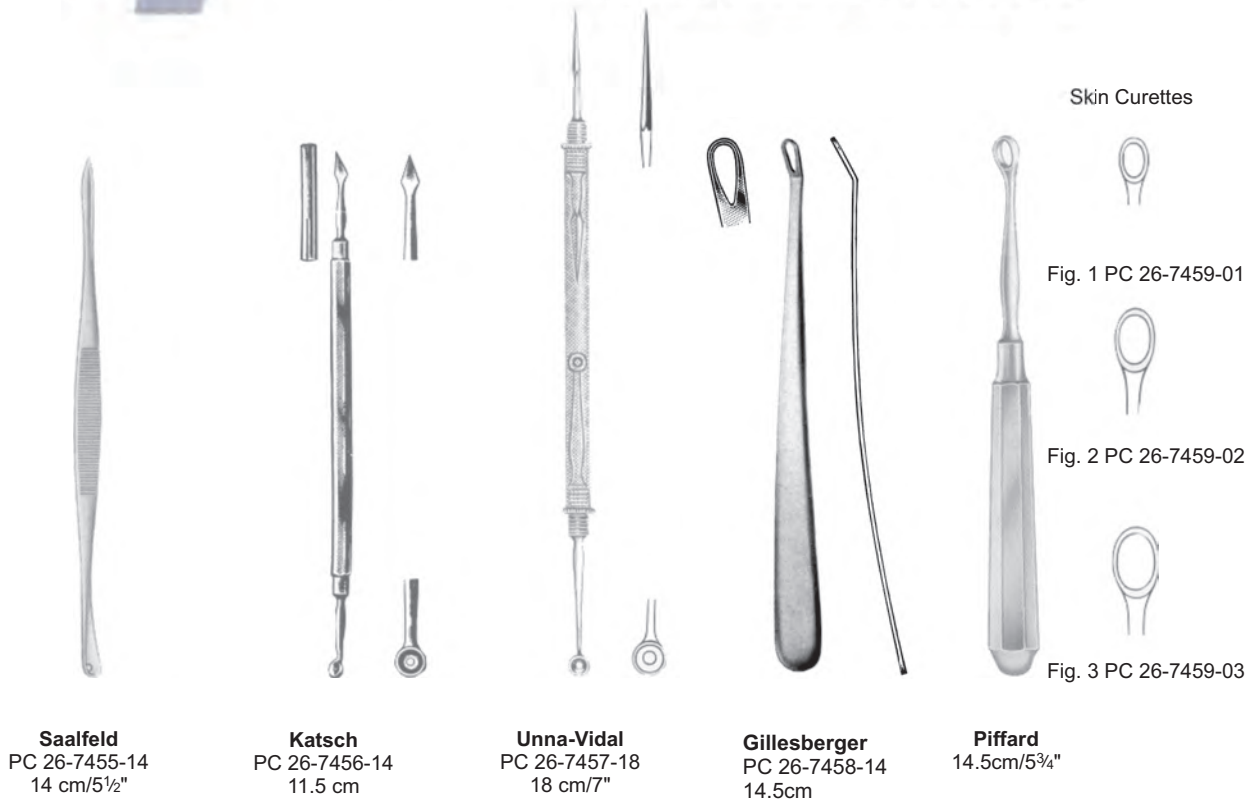

**Saalfeld**  
PC 26-7455-14  
14 cm/5½"

**Katsch**  
PC 26-7456-14  
11.5 cm

**Unna-Vidal**  
PC 26-7457-18  
18 cm/7"

**Gillesberger**  
PC 26-7458-14  
14.5cm

**Piffard**  
14.5cm/5¾"

Fig. 1 PC 26-7459-01

Fig. 2 PC 26-7459-02

Fig. 3 PC 26-7459-03

Lupus Currettes, Scraper, Moncorps Knife — EN  
 Lupus Küretten, Schaber, Messer — DE  
 Curetas lupus, raspador, cuchillos — ES

Lupus Currettes

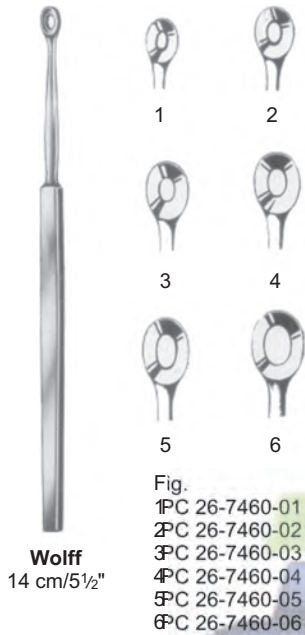

Lupus Currettes Lupus Scraper

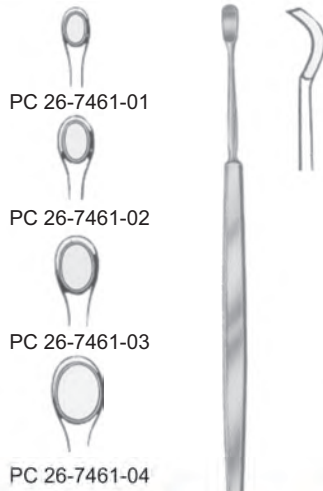

Moncorps Knife



Cutaneous Hook



**KEYS**  
10.0cm

- 1 ○ PC 26-7466-02 2mm
- 2 ○ PC 26-7466-03 3mm
- 3 ○ PC 26-7466-04 4mm
- 4 ○ PC 26-7466-05 5mm
- 5 ○ PC 26-7466-06 6mm
- 6 ○ PC 26-7466-07 7mm
- 7 ○ PC 26-7466-08 8mm

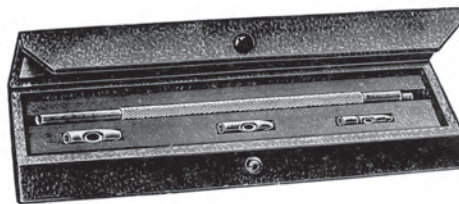

PC 26-7467-00  
 Biopsy set for taking skin specimen  
 core drills 1.5, 3.0, 4.5mm ø

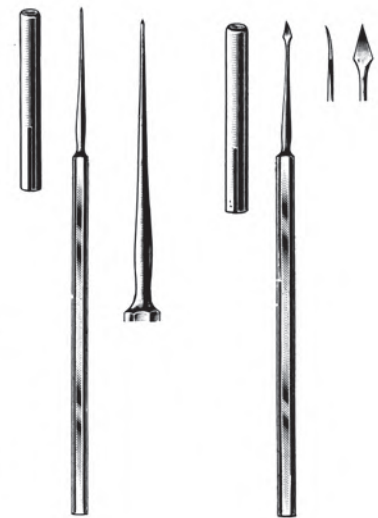

PC 26-7468-13  
13.0cm

PC 26-7469-13  
13.0cm

**EN** Tracheotomy

**DE** Tracheotomie

**ES** Traqueotomía

**Page 641 to 650**



**TRACHEOTOMY**

- EN —● Trachea Dilators and Retractors
- DE —● Tracheal-Häkchen, Dilatoren
- ES —● Separadores para la tráquea, Diladores

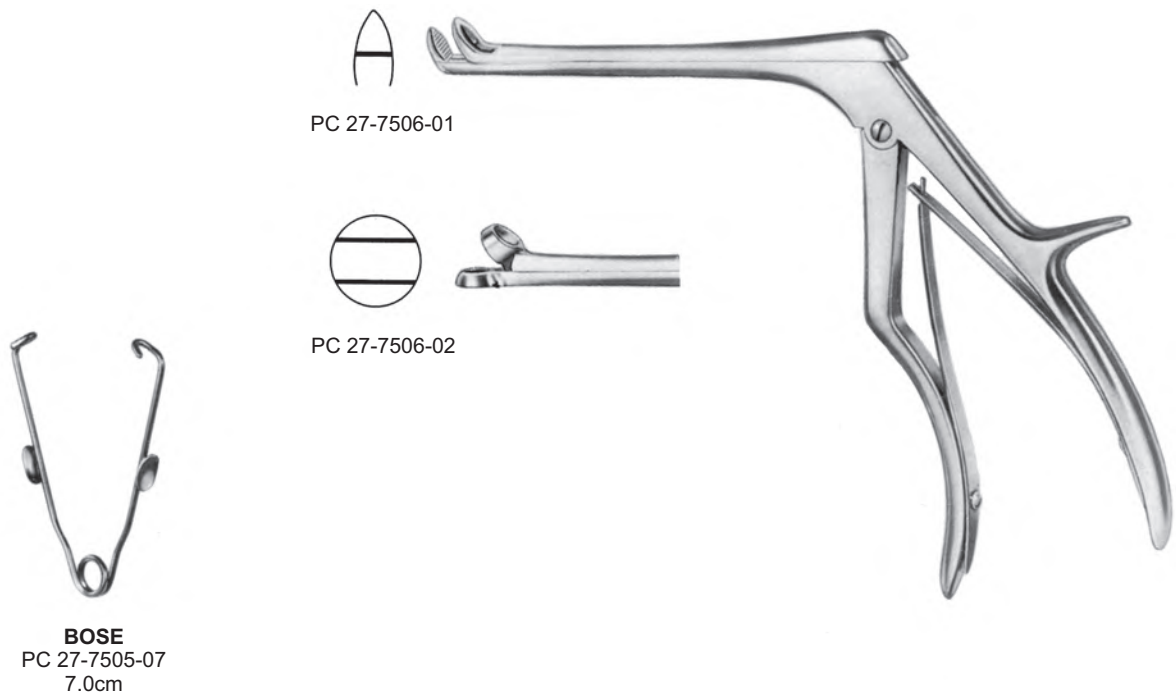
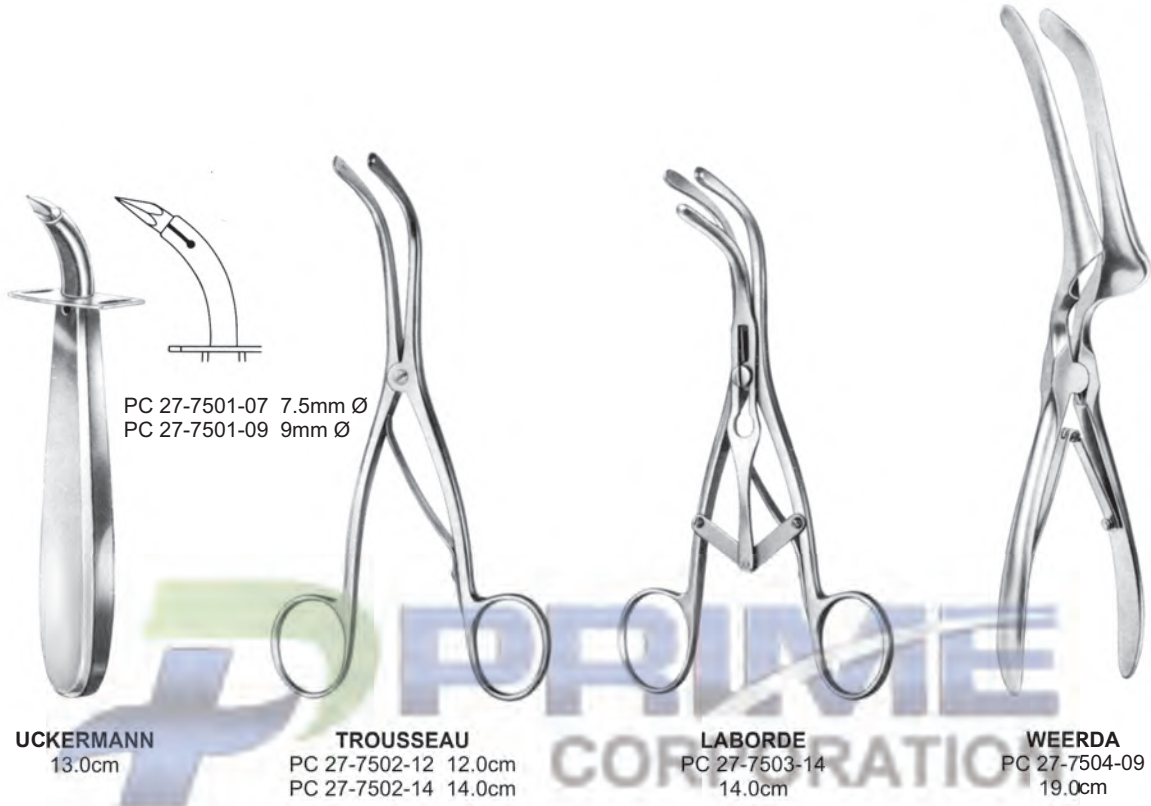



Trachea Retractors ●— EN  
Tracheal-Häkchen ●— DE  
Separadores para le traquea ●— ES



**LUKENS**  
PC 27-7507-17  
17.0cm



**JACKSON**  
PC 27-7508-17  
17.0cm



**JACKSON**  
sharp blunt  
PC 27-7509-18 18.0cm PC 27-7510-18



PC 27-7511-01 sharp  
PC 27-7511-02 blunt  
18.0cm



PC 27-7512-01 sharp  
PC 27-7512-02 blunt  
18.0cm



**SCHOENBORN**  
PC 27-7513-21  
21.0cm

- EN —● Trachea Retractors
- DE —● Tracheal-Häkchen
- ES —● Separadores para le tráquea



**ROSE**  
PC 27-7514-13  
13.0cm



**LUER**  
PC 27-7515-11  
11.0cm



**JACKSON**  
PC 27-7516-15  
15.0cm



PC 27-7517-15  
15.0cm



**ITERSON**  
16.0cm



PC 27-7518-01  
Sharp



PC 27-7518-02  
Blunt



**BOSE**  
PC 27-7519-16  
16.0cm

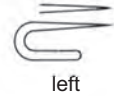

left



**BOSE**  
PC 27-7520-16  
16.0cm

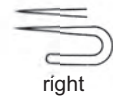

right

- Trachea Tubes ●— EN
- Tracheal-Kanülen ●— DE
- Cánulas traqueales ●— ES

International scale

Fig.	0	1	2	3	4	5	6	7	8	9
Diameter	④	⑤	⑥	⑦	⑧	⑨	⑩	⑪	⑫	⑬mm
Lenght of outer tube N	45	50	55	60	65	70	75	80	85	90mm



### LUER

Fig	mmØ	45-90mm	95mm	105mm
0	4			
1	5			
2	6			
3	7			
4	8		PC 27-7522-08	PC 27-7523-08
5	9		PC 27-7522-09	PC 27-7523-09
6	10		PC 27-7522-10	PC 27-7523-10
7	11		PC 27-7522-11	PC 27-7523-11
8	12		PC 27-7522-12	PC 27-7523-12
9	13		PC 27-7522-13	PC 27-7523-13

### CHEVALIER-JACKSON

Fig	mmØ	45-90mm
0	4	PC 27-7524-04
1	5	PC 27-7524-05
2	6	PC 27-7524-06
3	7	PC 27-7524-07
4	8	PC 27-7524-08
5	9	PC 27-7524-09
6	10	PC 27-7524-10
7	11	PC 27-7524-11
8	12	PC 27-7524-12
9	13	PC 27-7524-13

EN —● Trachea Tubes  
 DE —● Tracheal-Kanülen  
 ES —● Cánulas traqueales

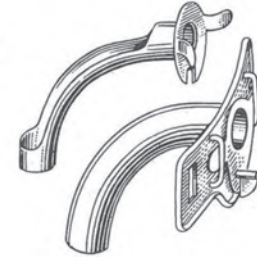
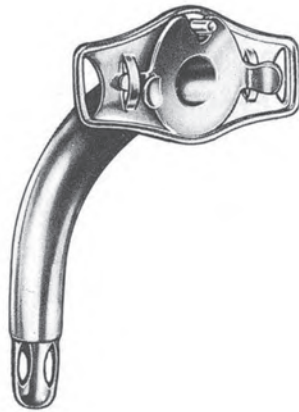

**KRISHABER**

Fig	mm	
0	4	PC 27-7525-04
1	5	PC 27-7525-05
2	6	PC 27-7525-06
3	7	PC 27-7525-07
4	8	PC 27-7525-08
5	9	PC 27-7525-09
6	10	PC 27-7525-10
7	11	PC 27-7525-11
8	12	PC 27-7525-12

**KRISHABER-LUER**

Fig	mm	
0	4	PC 27-7526-04
1	5	PC 27-7526-05
2	6	PC 27-7526-06
3	7	PC 27-7526-07
4	8	PC 27-7526-08
5	9	PC 27-7526-09
6	10	PC 27-7526-10
7	11	PC 27-7526-11
8	12	PC 27-7526-12

**PARKER**

Fig	F.G	
1	16	PC 27-7527-16
2	18	PC 27-7527-18
3	20	PC 27-7527-20
4	22	PC 27-7527-22
5	24	PC 27-7527-24
6	26	PC 27-7527-26
7	28	PC 27-7527-28
8	30	PC 27-7527-30
9	32	PC 27-7527-32

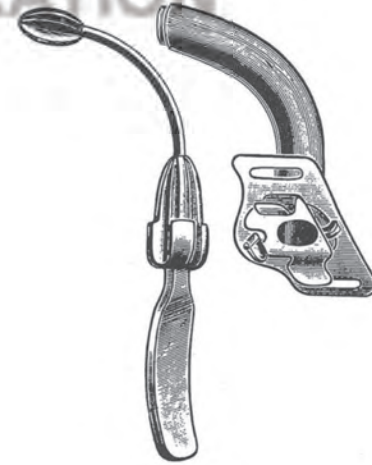
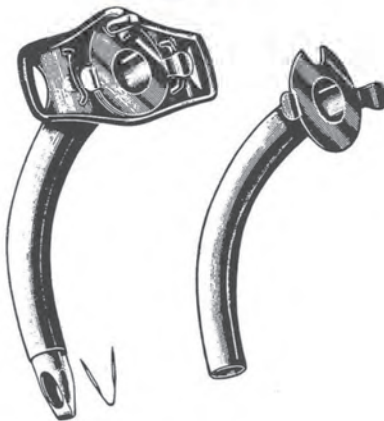

**COLLIN**

Fig	mm	
0	4	PC 27-7528-04
1	5	PC 27-7528-05
2	6	PC 27-7528-06
3	7	PC 27-7528-07
4	8	PC 27-7528-08
5	9	PC 27-7528-09
6	10	PC 27-7528-10
7	11	PC 27-7528-11
8	12	PC 27-7528-12

**FULLER**

Fig	F.G	
1	18	PC 27-7529-18
2	20	PC 27-7529-20
3	22	PC 27-7529-22
4	24	PC 27-7529-24
5	26	PC 27-7529-26
6	28	PC 27-7529-28
7	30	PC 27-7529-30
8	32	PC 27-7529-32

**CUBLEY**

Fig	F.G	
1	16	PC 27-7530-16
2	18	PC 27-7530-18
3	20	PC 27-7530-20
4	22	PC 27-7530-22
5	24	PC 27-7530-24
6	26	PC 27-7530-26
7	28	PC 27-7530-28
8	30	PC 27-7530-30
9	32	PC 27-7530-32

Trachea Tubes ●— EN  
 Tracheal-Kanülen ●— DE  
 Cánulas traqueales ●— ES

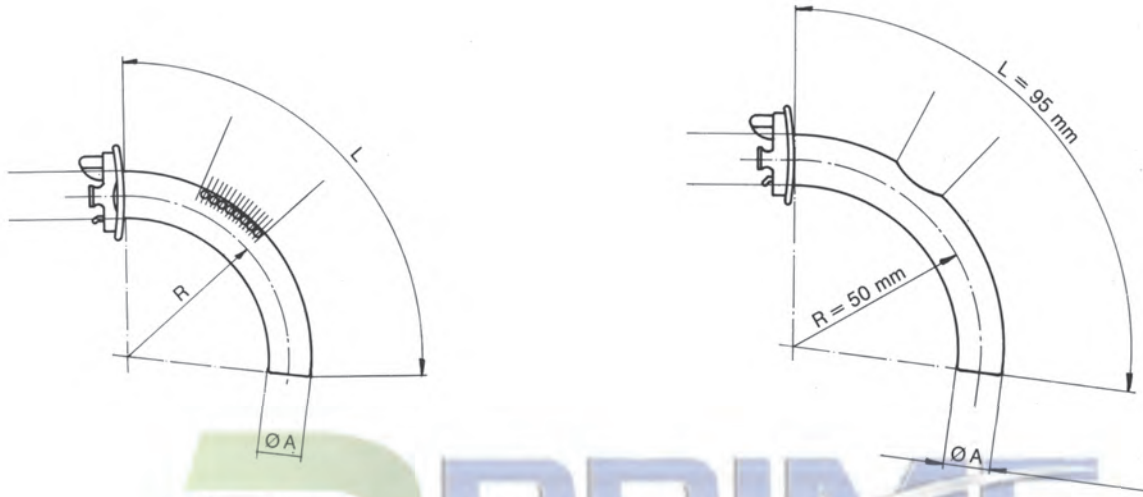
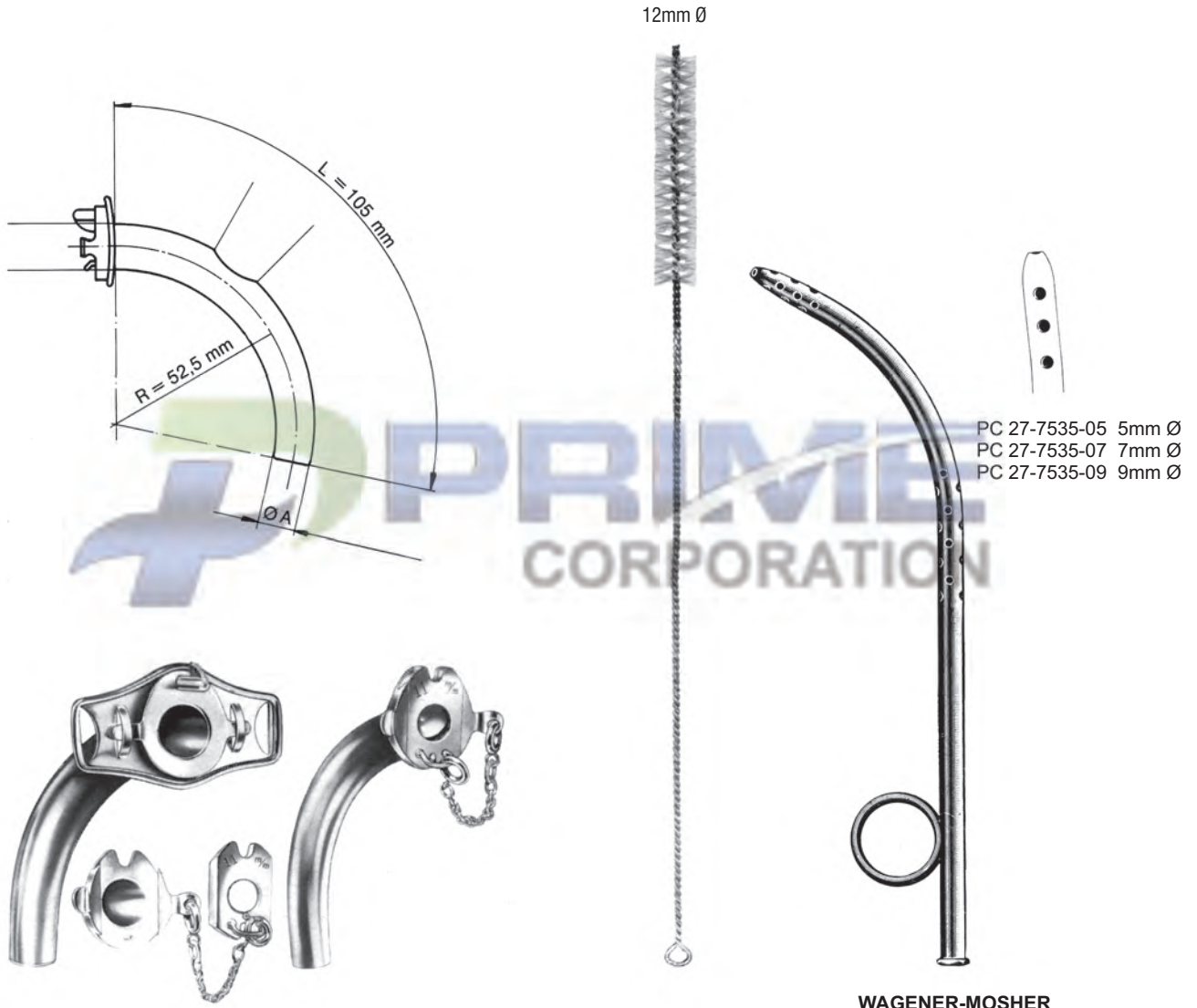

Fig		ØA	L	R
0	PC 27-7531-08	8	65	36.5
1	PC 27-7531-09	9	70	29
2	PC 27-7531-10	10	75	40.5
3	PC 27-7531-11	11	80	41.5
4	PC 27-7531-12	12	85	43
5	PC 27-7531-13	13	90	47.5

Fig		ØA	L	R
0	PC 27-7532-08	8	95	50
1	PC 27-7532-09	9	95	50
2	PC 27-7532-10	10	95	50
3	PC 27-7532-11	11	95	50
4	PC 27-7532-12	12	95	50
5	PC 27-7532-13	13	95	50



- EN —● Trachea Tubes
- DE —● Tracheal-Kanülen
- ES —● Cánulas traqueales



PC 27-7535-05 5mm Ø  
 PC 27-7535-07 7mm Ø  
 PC 27-7535-09 9mm Ø

PC 27-7534-26  
 26.0cm

**WAGENER-MOSHER**  
 20.0cm

Fig		ØA	L	R
0	PC 27-7533-08	8	105	52.5
1	PC 27-7533-09	9	105	52.5
2	PC 27-7533-10	10	105	52.5
3	PC 27-7533-11	11	105	52.5
4	PC 27-7533-12	12	105	52.5
5	PC 27-7533-13	13	105	52.5

- Trachea Tubes ●— EN
- Tracheal-Kanülen ●— DE
- Cánulas traqueales ●— ES

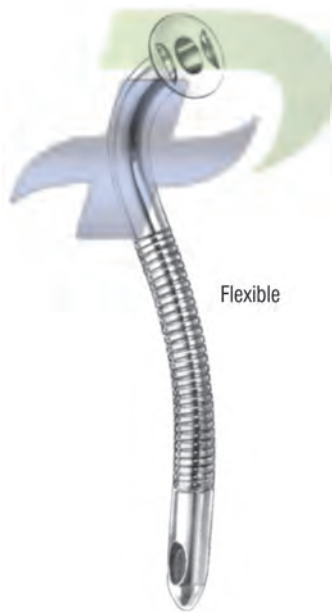
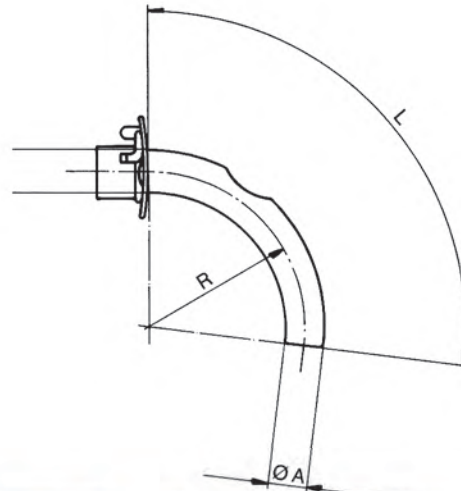

### KOENIG

Fig	mmØ	50-80mm
1	5	PC 27-7536-05
2	6	PC 27-7536-06
3	7	PC 27-7536-07
4	8	PC 27-7536-08
5	9	PC 27-7536-09
6	10	PC 27-7536-10
7	11	PC 27-7536-11

Fig		ØA	L	R
0	PC 27-7537-08	8	65	36.5
1	PC 27-7537-09	9	70	39
2	PC 27-7537-10	10	75	40.5
3	PC 27-7537-11	11	80	41.5
4	PC 27-7537-12	12	85	43
5	PC 27-7537-13	13	90	47.5

- EN —● Tracheotomy Set  
 DE —● Tracheotomie-Besteck  
 ES —● Estuche para traqueotomía

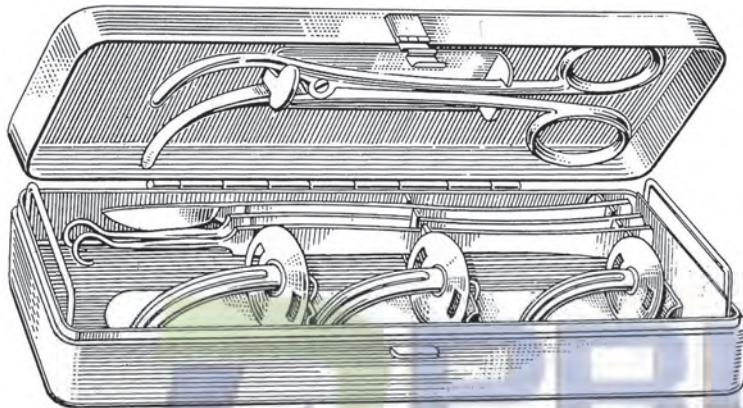

PC 27-7538-00

**TRACHEOTOMY SET**

PC 27-7538-00

complete in stainless steel case comprising:

- Fuller tracheotomy tube, 18
- Fuller tracheotomy tube, 22
- Fuller tracheotomy tube, 26
- Tracheal hook, sharp
- Tracheal hook, blunt
- Scalpel, stainless, 3cm
- Trousseau, tracheal, dilating forcep

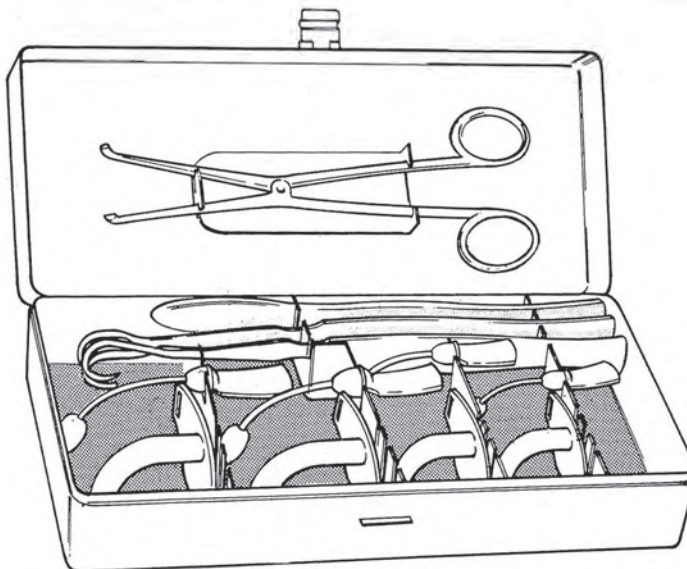

PC 27-7539-00

**TRACHEOTOMY SET**

PC 27-7539-00

complete in stainless steel case comprising:

- Parker tracheotomy tube, 18
- Parker tracheotomy tube, 22
- Parker tracheotomy tube, 24
- Parker tracheotomy tube, 26
- Tracheal hook, sharp.
- Tracheal hook, double blunt.
- Scalpel, stainless, 3cm
- Trousseau, tracheal, dilating forcep

- Tracheotomy Set ●— EN
- Tracheotomie-Besteck ●— DE
- Estuche para traqueotomia ●— ES

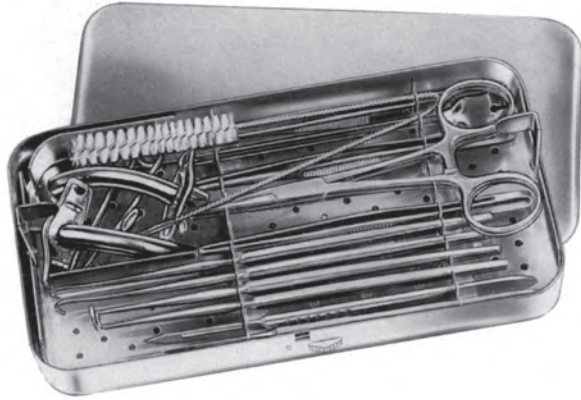

PC 27-7540-00  
200 x 105 x 30mm

### TRACHEOTOMY SET

PC 27-7540-00

complete in metal case, consisting of:

- 1 Handle with 1 blade, Fig. 20
- 1 Handle with 1 blade, Fig. 23
- 1 Thumb forceps, 13.0cm
- 1 Tissue forcep, 13.0cm 1 x 2 teeth
- 2 Pean Artery Forceps, 13.0cm
- 1 Grooved Director, 14.0cm
- 1 Trachea Dilator
- 2 Iterson Trachea Retractors, blunt
- 1 Bose Trachea Retractor, sharp left hand side
- 1 ditto, right hand side
- 1 Luer Trachea Tube, Standard
- 1 ditto
- 1 Cleaning Brush

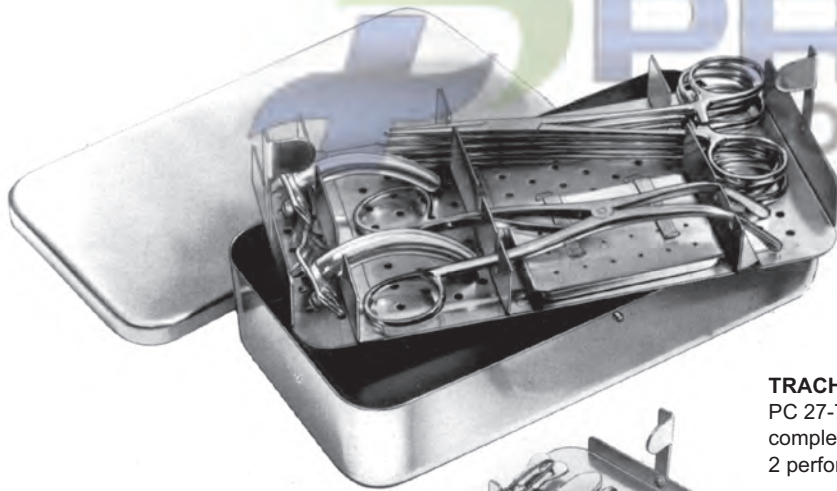

PC 27-7541-00  
200 x 100 x 40mm

### TRACHEOTOMY SET

PC 27-7541-00

complete in metal case 200 x 100 x 40 mm, with 2 perforated trays of 18/8 s/s containing the following instruments:

- 1 Scalpel Handle No. 4, with blade No. 20
- 1 Scalpel Handle No. 4, with blade No. 23
- 3 Scalpel Blades, assorted, in perforated small case.
- 1 Small case for above Scalpel Blades
- 1 Dressing Forceps, serrated, 13.0cm
- 2 Tissue Forceps, 1 x 2 teeth, 13.0cm
- 4 Crile Artery Forceps, straight, 14.0cm
- 1 Grooved Director, 14.0cm
- 1 Trousseau Trachea Dilator, 14.0cm
- 2 Iterson Trachea Hooks, blunt
- 1 Bose Hook, sharp, left hand side, 16.0cm
- 1 ditto, right hand side, 16.0cm
- 1 Luer Trachea Tube, size 2.6mm diam. German Silver.
- 1 ditto, size 4.8mm diam, German Silver.
- 1 Cleaning Brush, 12mm diam. 26.0cm



- EN** Ophthalmology
- DE** Ophthalmologie
- ES** Oftalmología

**Page 651 to 681**

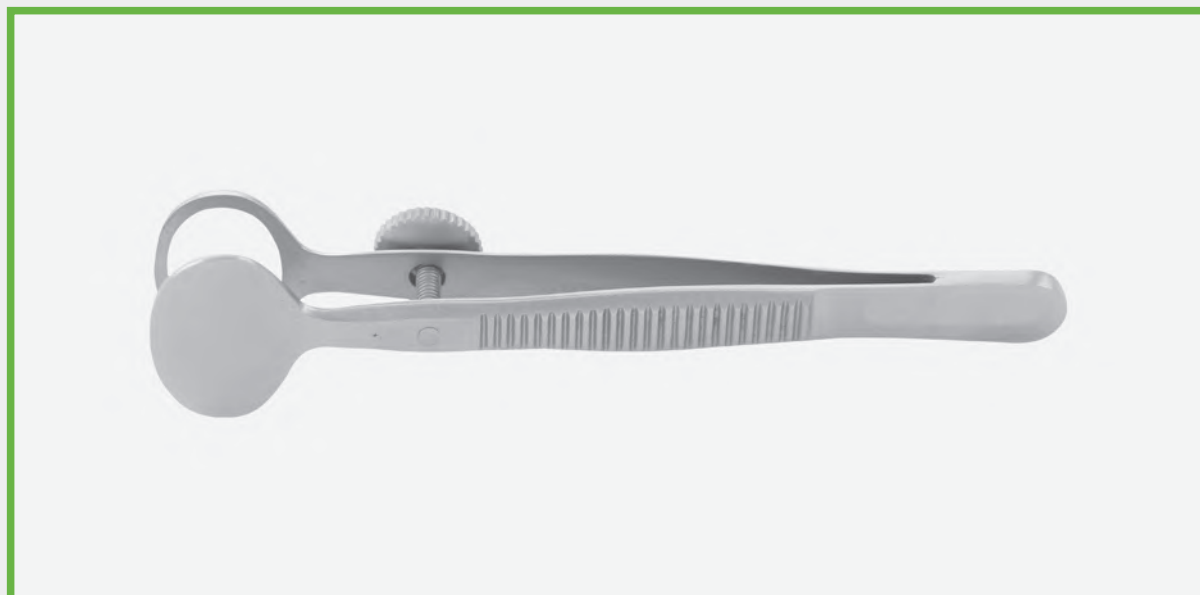



EN —● Eye Speculas  
 DE —● Lidsperrer  
 ES —● Espéculos ojo



**Children Weiss**  
 PC 28-7601-07  
 7 cm/2 4"



**Children Weiss**  
 PC 28-7603-07  
 7 cm/2 3/4"



**Adults**  
 PC 28-7604-09  
 9 cm/3 1/2"



**Park**  
 PC 28-7605-08  
 8 cm/3 1/4"



**Park-Guyton**  
 PC 28-7606-08  
 8 cm/3 1/4"



**Barraquer (Colibri)**  
 Children PC 28-7608-03  
 3 cm/1 1/4"



**Adults**  
 PC 28-7609-04  
 4 cm/1 1/2"



**Bowman**  
 PC 28-7611-07  
 7 cm/2 3/4"



**Sauer**  
 PC 28-7612-03  
 3 cm/1 1/4"



**Goldstein**  
 PC 28-7613-03  
 3 cm/1 1/4"



**Pley**  
 PC 28-7614-06  
 6 cm/2 1/4"

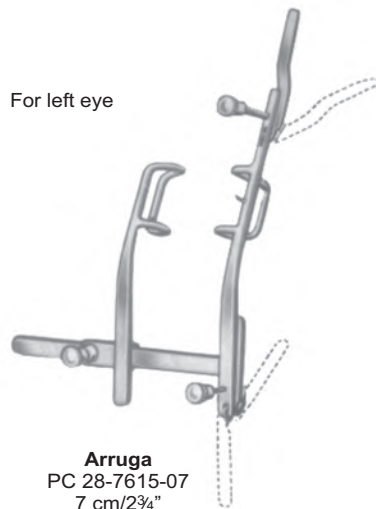

For left eye

**Arruga**  
 PC 28-7615-07  
 7 cm/2 3/4"

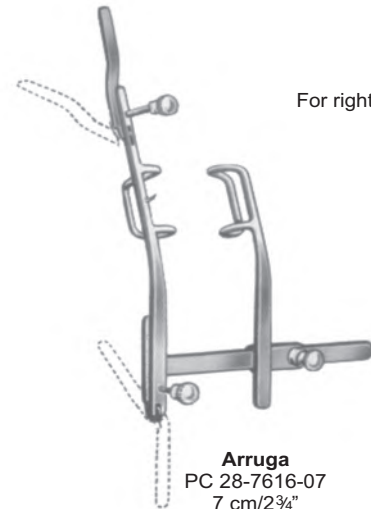

For right eye

**Arruga**  
 PC 28-7616-07  
 7 cm/2 3/4"

Eye Speculas ●— EN  
 Lidsperrer ●— DE  
 Espéculos ojo ●— ES



**Mellinger-Axenfeld**  
 PC 28-7617-07  
 7 cm/2 3/4"



**Mellinger-Axenfeld**  
 PC 28-7618-07  
 7 cm/2 3/4"



Children **Mellinger** Adults  
 PC 28-7619-05 PC 28-7620-07  
 5 cm/2 3/4" 7 cm/2 3/4"



Children **Mellinger Beard** Adults  
 PC 28-7621-05 PC 28-7622-07  
 5 cm/2" 7 cm/2 "



**Knapp Clark**  
 PC 28-7623-08  
 8 cm/3 1/4"



Children **Graefe** Adults  
 PC 28-7624-06 PC 28-7625-09  
 6 cm/2 1/2" 9 cm/3 1/2"



**Lancaster**  
 PC 28-7626-08  
 8 cm/3 1/4"



Children **Williams** Adults  
 PC 28-7627-07 PC 28-7628-08  
 7 cm/2 3/4" 8 cm/3 "



**Lister-Burch**  
 PC 28-7629-08  
 8 cm/3 1/4"



**Weiss**  
 PC 28-7630-08  
 8 cm/3 1/4"



**Murdock**  
 PC 28-7631-05  
 5 cm/2"



**Mueller**  
 PC 28-7632-07  
 7 cm/2 3/4"



**Critchett**  
 PC 28-7633-06  
 6 cm/2 1/2"



**Castroviejo**  
 PC 28-7634-08  
 8 cm/3 1/4"

- EN —● Lid Instruments
- DE —● Deckel Instruments
- ES —● Instrumentos tapa



**Schepens**  
PC 28-7635-13  
13 cm/5"



**Desmarres**  
PC 28-7636-13  
13 cm/5"



**Conway**  
PC 28-7637-13  
13 cm/5"

8 mm



PC 28-7638-12  
12 mm

PC 28-7638-14  
14 mm

PC 28-7638-16  
16 mm

PC 28-7638-18  
18 mm

**Desmarres**  
13 cm/5"

Lid plate



**Jaeger**  
PC 28-7639-11  
11 cm/4 1/2"

Eye Knives ●— EN  
 Eye Messer ●— DE  
 Cuchillos ojo ●— ES

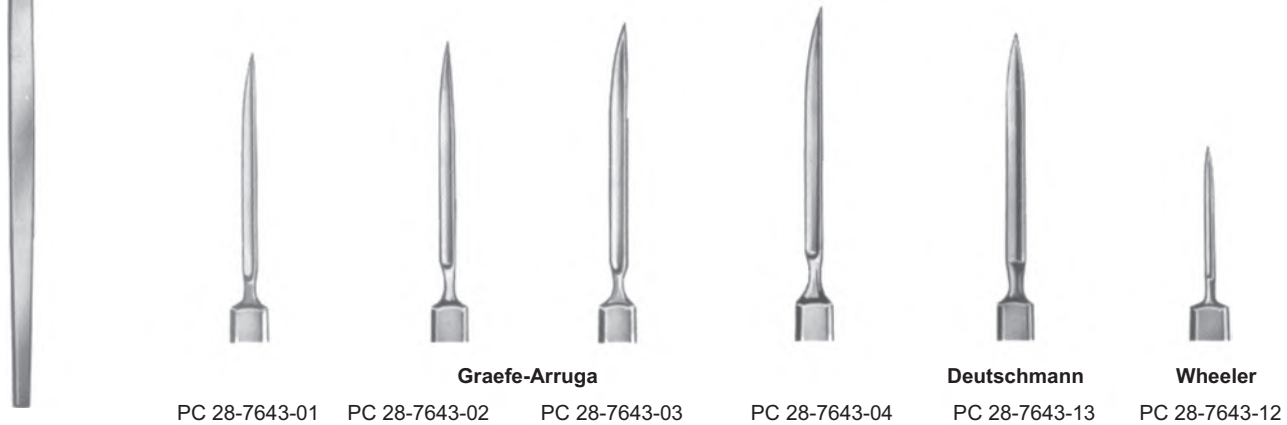
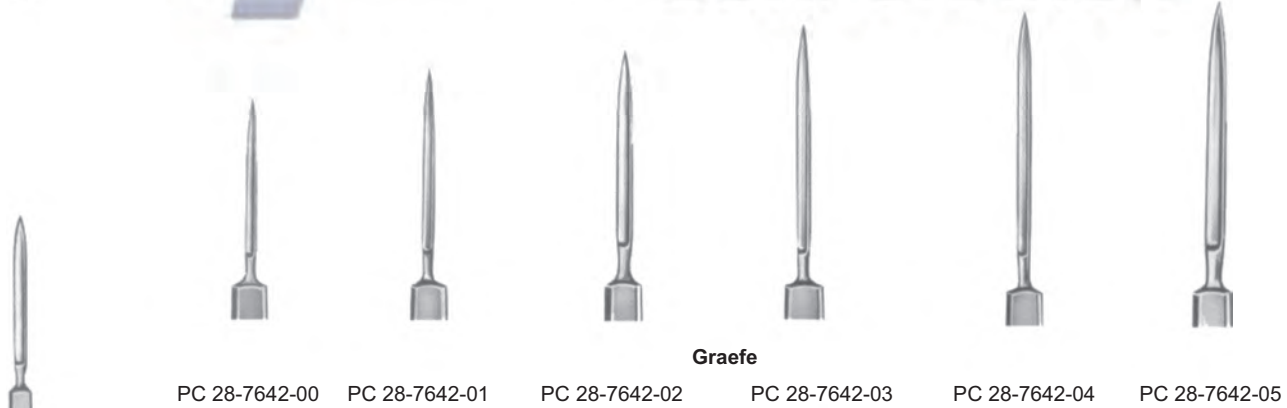
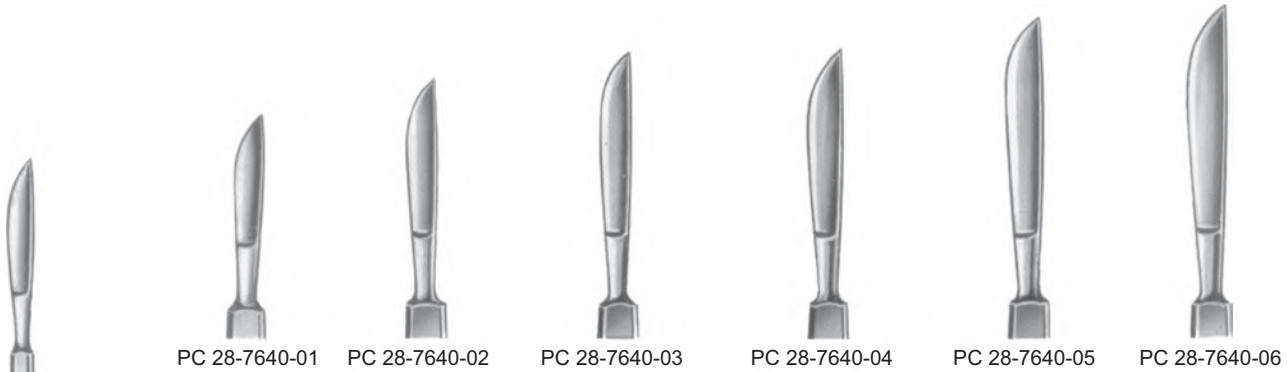

- EN —● Keratomes
- DE —● Keratomes
- ES —● Keratomes



PC 28-7644-02   PC 28-7644-03   PC 28-7644-04   PC 28-7645-01   PC 28-7645-02   PC 28-7645-03   PC 28-7645-04



**Jaeger**  
PC 28-7644-01

PC 28-7646-01   PC 28-7646-02   PC 28-7646-03   PC 28-7646-04



**Jaeger-Grieshaber**  
PC 28-7647-01   PC 28-7647-02   PC 28-7647-03   PC 28-7647-04

**Jaeger-Grieshaber**  
PC 28-7648-01   PC 28-7648-02   PC 28-7648-03   PC 28-7648-04



Keratomes, Various Eye Knives ●— EN  
 Keratomes, Verschiedene Eye Messer ●— DE  
 Keratomes, varios cuchillos de ojos ●— ES



**Wessely-Grieshaber**

PC 28-7649-01 4 mm  
 PC 28-7649-02 5 mm  
 PC 28-7649-03 6 mm  
 PC 28-7649-04 7 mm

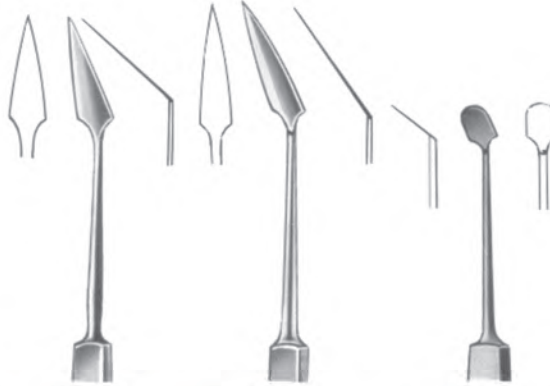

**Wiener**

PC 28-7650-13

**Berens**

PC 28-7651-13

**Papst**

PC 28-7652-13

**Castroviejo**

PC 28-7653-13



**Castroviejo**  
 PC 28-7654-09  
 9 cm/3½"



**Castroviejo**  
 PC 28-7655-09  
 9 cm/3½"



**Castroviejo**  
 PC 28-7656-09  
 9 cm/3½"

- EN —● Various Eye Knives
- DE —● Verschiedene Eye Messer
- ES —● Varios cuchillos de ojos



**Mod. Hamburg**  
PC 28-7657-12



**Graefe**  
PC 28-7658-13



**Weber**  
PC 28-7659-01



**Weber**  
PC 28-7659-02



**Weber**  
PC 28-7659-03



**Bowman**  
PC 28-7660-04  
0.4 mm



**Bowman**  
PC 28-7660-05  
0.5 mm



**Bowman**  
PC 28-7660-06  
0.6 mm



**Bowman**  
PC 28-7660-07  
0.7 mm



**Bowman**  
PC 28-7660-08  
0.8 mm



Left **Bowman** Right  
PC 28-7661-01 PC 28-7661-02



PC 28-7662-01



**Knapp**  
PC 28-7662-02



PC 28-7662-03



**Ziegler**  
PC 28-7663-05  
5 mm



**Ziegler**  
PC 28-7663-06  
6 mm



**Ziegler**  
PC 28-7663-07  
7 mm

Various Eye Knives ●— EN  
 Verschiedene Eye Messer ●— DE  
 Varios cuchillos de ojos ●— ES



**Dean**  
PC 28-7664-13



**Zigler**  
PC 28-7665-11  
3½ mm



**Sato**  
PC 28-7666-12



**Sichel**  
PC 28-7667-13



**Graefe**  
PC 28-7668-13



**Graefe**  
PC 28-7669-13



PC 28-7670-01



**Kuhnt**  
PC 28-7671-02



PC 28-7672-03



PC 28-7673-04



**Paton**  
PC 28-7674-12



**Elsching**  
PC 28-7675-13



**Took**  
PC 28-7676-12



PC 28-7677-01



**Desmarres**  
PC 28-7678-02



PC 28-7679-03



**Gill**  
PC 28-7680-12

- EN —● Fixation Claws and Hooks
- DE —● Fixation Claws und Haken
- ES —● Garras y ganchos de fijación



**Guthrie**  
PC 28-7681-12



**Guthrie**  
PC 28-7682-13



**Berens**  
PC 28-7683-12



**Knapp Blunt**  
PC 28-7684-13



**Rollet Sharp**  
PC 28-7685-12



**Rollet Blunt**  
PC 28-7686-12



**Fink Blunt**  
PC 28-7687-12



Right  
PC 28-7688-01

Left  
PC 28-7688-02

10.5 cm/4 1/4"



**Knapp-Rollet**  
PC 28-7689-02



Flexible  
PC 28-7689-03 PC 28-7689-04

Hooks, Protectors and Spatulas ●— EN  
 Hooks, Protektoren und Spatel ●— DE  
 Ganchos, protectores y espátulas ●— ES

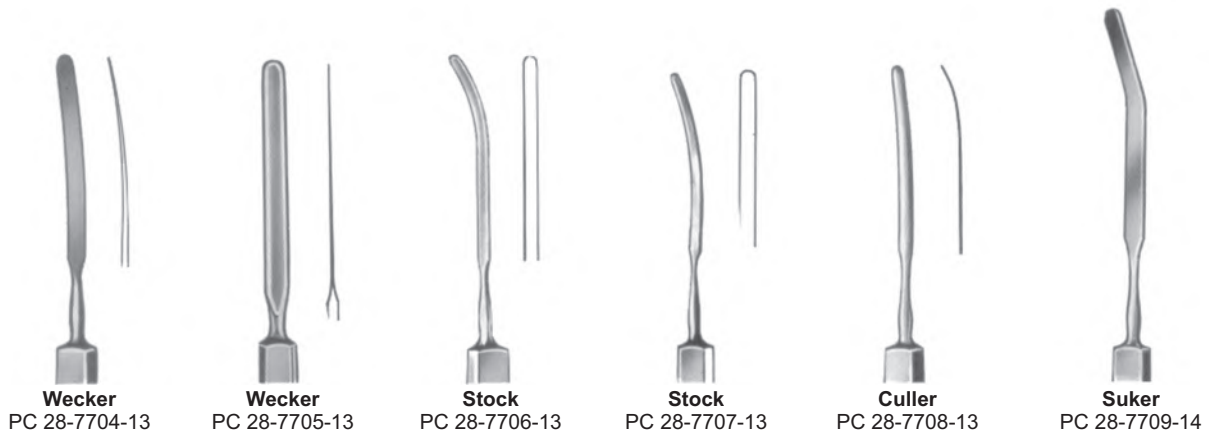
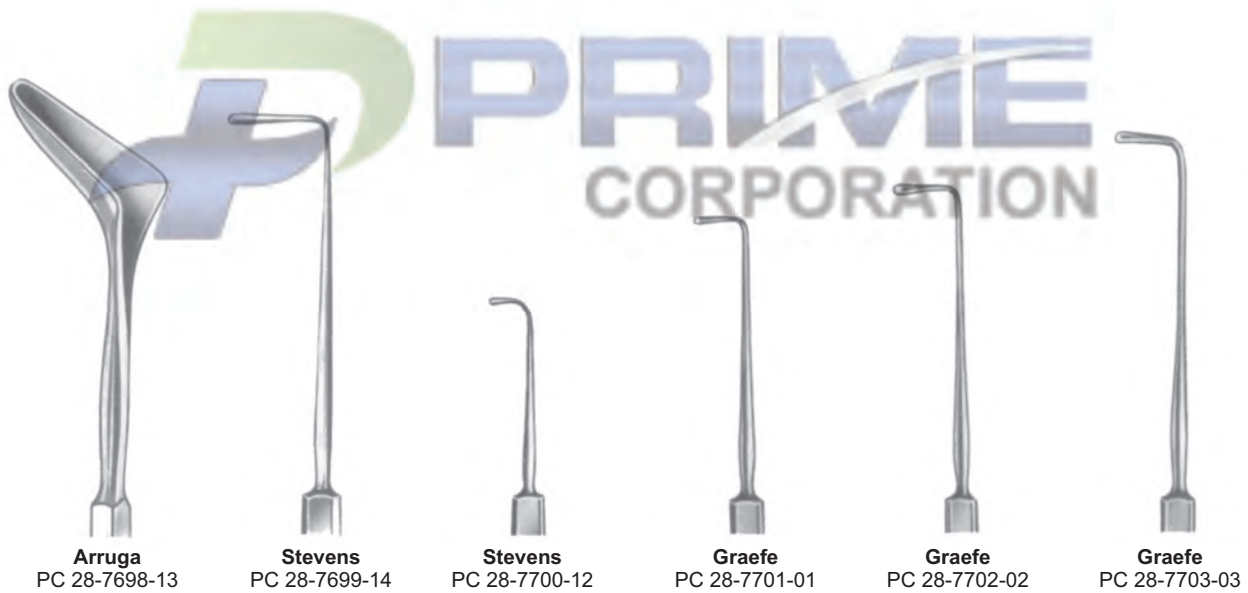
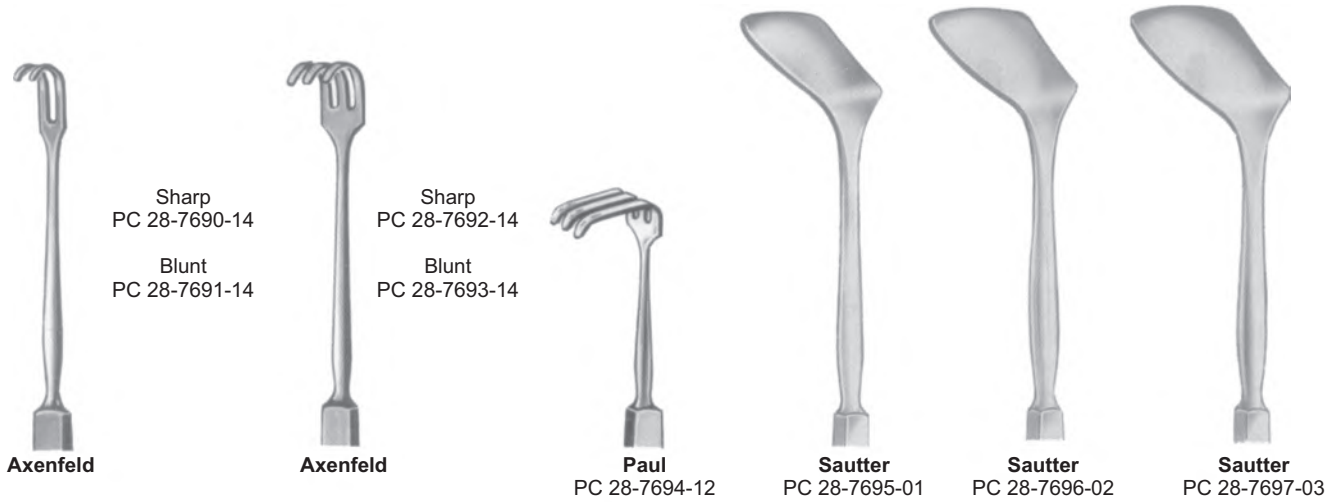



- EN —● Enucleation Scoops and Chalazion Curettes
- DE —● Enucleation Schaufeln und Chalazion Küretten
- ES —● Enucleación Scoops y curetas Chalazión

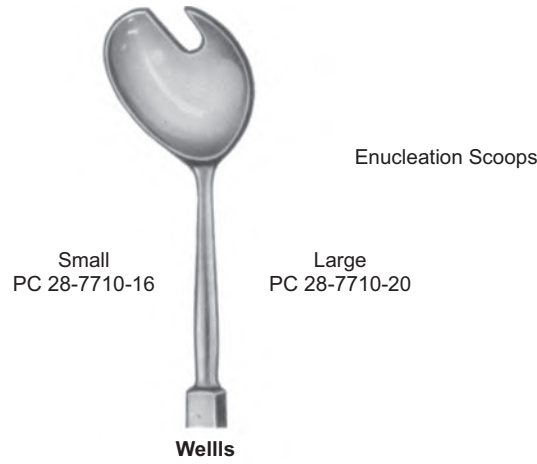

Chalazion Curettes

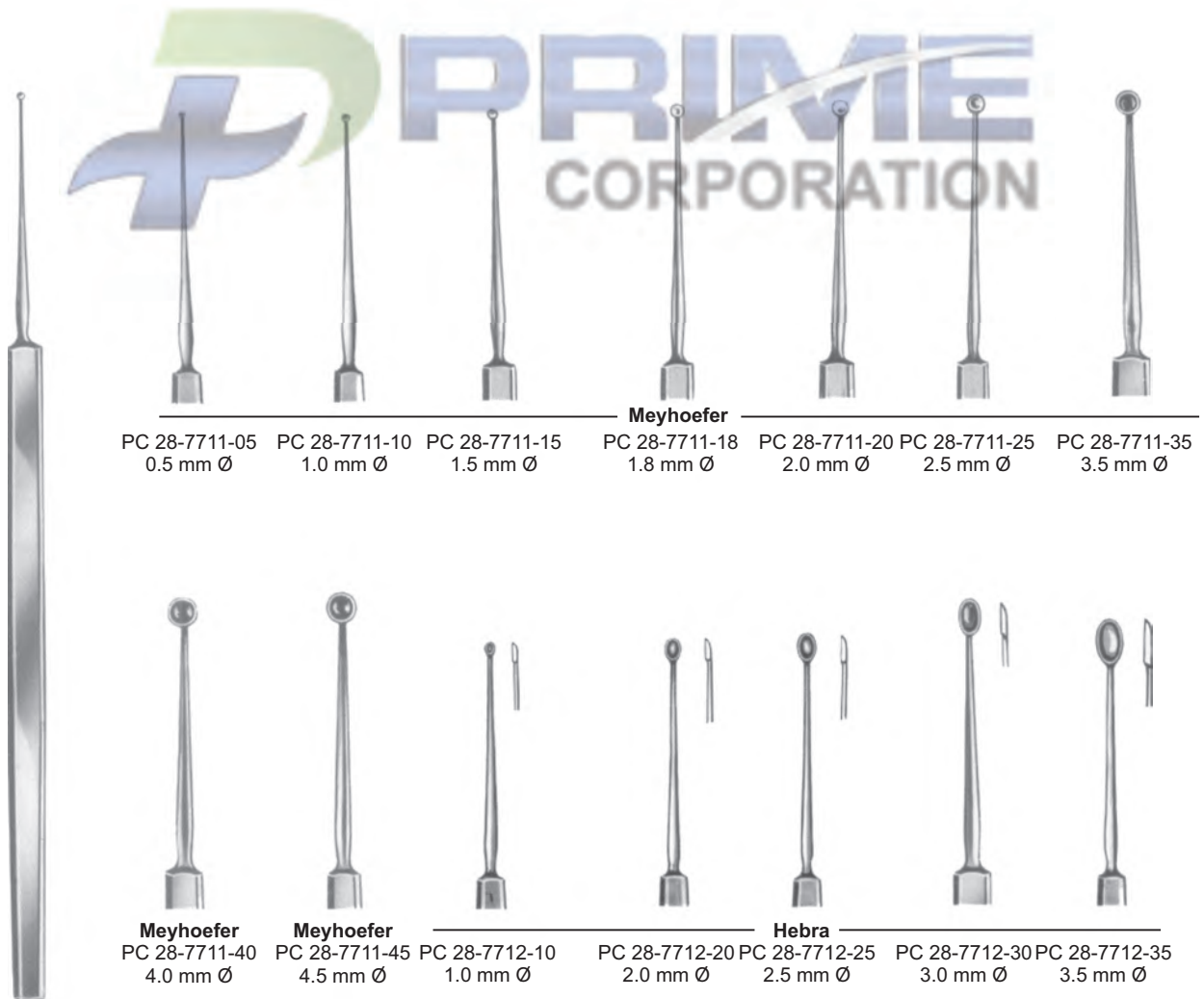

- Exenteration Scoops and Chalazion Curettes ● EN
- Exenteration Schaufeln und Chalazion Küretten ● DE
- Exenteración Scoops y Chalazión Curetas ● ES

Exenteration Scoops



PC 28-7713-01    PC 28-7713-02    **Bunge** PC 28-7713-03    PC 28-7713-04    PC 28-7713-05



Chalazion Curette, Double

**Axenfeld**  
PC 28-7714-13  
13 cm/5"



Lachrymal Sac Dissector

**Lang**  
PC 28-7715-13  
13 cm/5"

EN —● Eye Cannulas  
 DE —● Augenkanülen  
 ES —● Cánulas ojo

Irrigating Cannulas

Straight



**Binkhorst**  
 PC 28-7716-01  
 22 gauge

Right



**Binkhorst**  
 PC 28-7717-02  
 22 gauge

Left



**Binkhorst**  
 PC 28-7718-03  
 22 gauge



**Bonn**  
 PC 28-7719-04  
 20 gauge



**Bonn**  
 PC 28-7720-05  
 19 gauge

Probe Point



**Hamburg**  
 PC 28-7721-06  
 23 gauge



**Simcoe**  
 PC 28-7722-01  
 23 gauge

Irrigation/Aspiration Cannulas

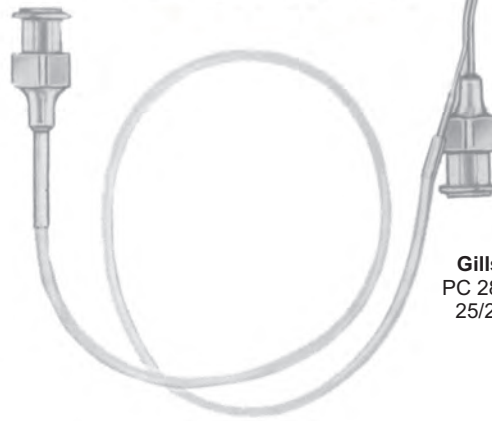

stotome Cannulas

**Gills-Welsh**  
 PC 28-7723-02  
 25/23 gauge



**Knolle-Kelmann**  
 PC 28-7724-01  
 22 gauge



**Nevyas**  
 PC 28-7725-02  
 22 gauge



**Kratz**  
 PC 28-7726-03  
 22 gauge



**Freeman**  
 PC 28-7727-01  
 27 gauge

Lens Mainpulation Cannulas

- Eye Cannulas ● EN
- Augenkanülen ● DE
- Cánulas ojo ● ES



**Sheets**  
PC 28-7728-01

Irrigating Vectis Cannulas



**Knolle Pearce**  
PC 28-7729-02

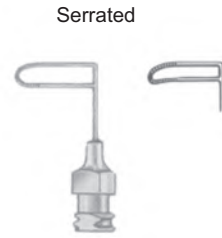

**Simcoe**  
PC 28-7730-03



Cortex Aspiration Cannulas

Capsule Polishing Cannulas



**Simcoe**  
PC 28-7731-01  
23 gauge



**Simcoe**  
PC 28-7732-02  
23 gauge



**Kratz**  
PC 28-7733-01



**Simcoe**  
PC 28-7734-02



**Jensen**  
PC 28-7735-03

Posterior

- EN —● Calipers, Markers, Punches Chisels
- DE —● Messschieber, Marker, Punches Meißel
- ES —● Pinzas, marcadores, cinceles Punzones



**Castroviejo**  
PC 28-7736-15



**Castroviejo**  
PC 28-7737-20  
20 mm



**Holth**  
PC 28-7738-01



**Haitz**  
PC 28-7739-02



**West**  
PC 28-7740-16  
16 cm/6 1/4"

**West**  
PC 28-7741-16  
16 cm/6 1/4"



**Connin-Amsler**  
PC 28-7742-13  
13 cm/5"



**Wilder**  
PC 28-7743-01



**Wilder**  
PC 28-7744-02



**Wilder**  
PC 28-7745-03





Lachrymal Dilators and Probes ●— EN  
 Lachrymal Dilatoren und Probes ●— DE  
 Dilatadores lagrimales y sondas ●— ES

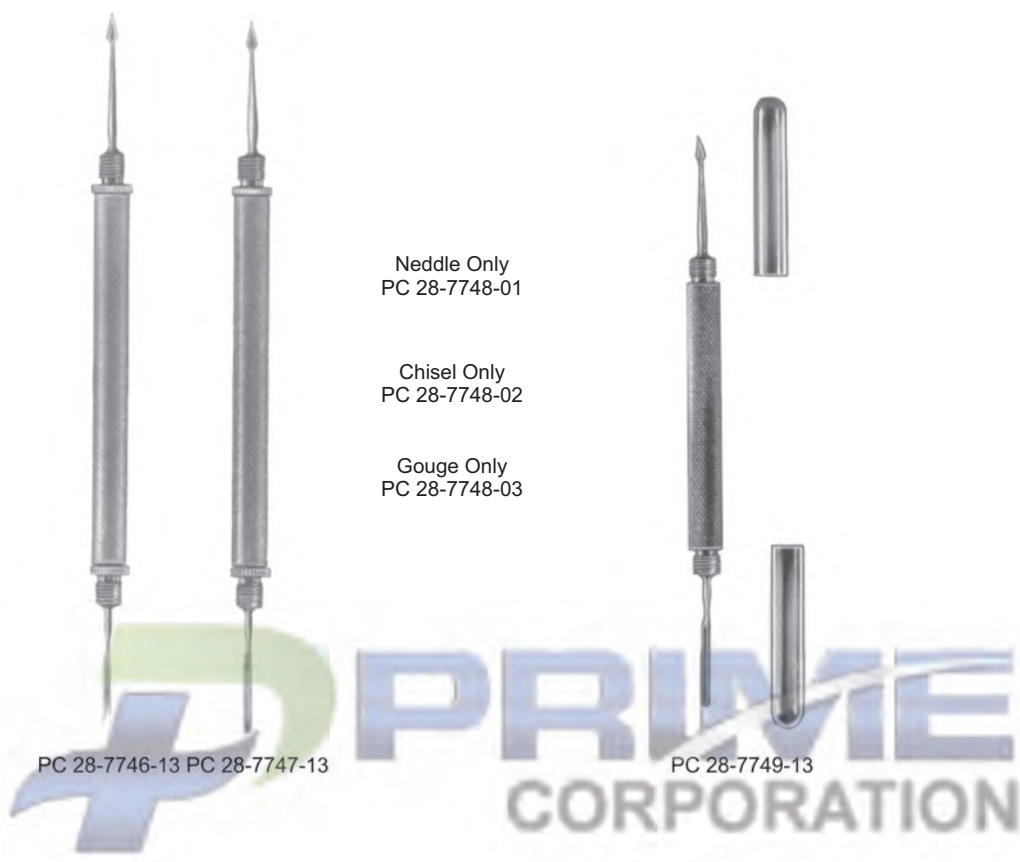

Needle Only  
 PC 28-7748-01

Chisel Only  
 PC 28-7748-02

Gouge Only  
 PC 28-7748-03

PC 28-7746-13 PC 28-7747-13

PC 28-7749-13



Instrumentation for D. B. Kirby Operations

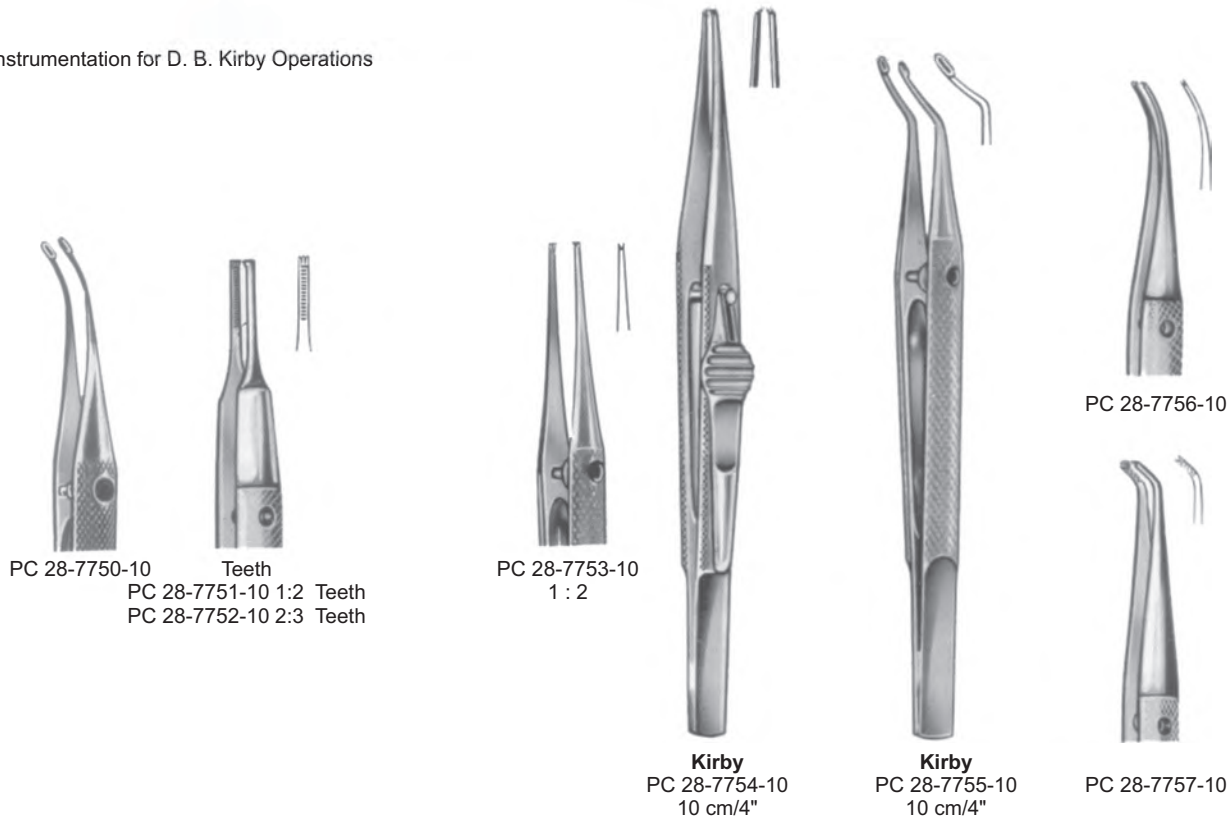

PC 28-7750-10  
 Teeth  
 PC 28-7751-10 1:2 Teeth  
 PC 28-7752-10 2:3 Teeth

PC 28-7753-10  
 1 : 2

**Kirby**  
 PC 28-7754-10  
 10 cm/4"

**Kirby**  
 PC 28-7755-10  
 10 cm/4"

PC 28-7756-10

PC 28-7757-10

- EN —● Suture Forceps  
 DE —● Suture Zange  
 ES —● Pinzas de sutura



**Tuebingen**  
 PC 28-7758-10  
 10 cm/4"



PC 28-7759-08  
 8.5 cm/3 1/2"



**Paufique**  
 PC 28-7760-10  
 10 cm/4"



**Barraquer**  
 PC 28-7761-10  
 10.5 cm/4 1/4"



**McPherson**  
 PC 28-7762-10  
 10 cm/4"



**McPherson**  
 PC 28-7763-07  
 7.5 cm/3"

Suture Forceps, Strabismus Forceps ●— EN  
 Suture Pinzetten, Zangen Strabismus ●— DE  
 Sutura Pinzas, estrabismo ●— ES



**McCullough**  
 PC 28-7764-09  
 9.5 cm/3 3/4"



**McCullough**  
 PC 28-7765-09  
 9.5 cm/3 3/4"



**Bonaccoito**  
 PC 28-7766-10  
 10 cm/4"



**Bonaccoito**  
 PC 28-7767-10  
 10 cm/4"



**PC 28-7768-11**  
 11 cm/4 1/2"



11 cm/4 1/2"



**PC 28-7769-11**  
 1 : 2



**PC 28-7770-11**  
 2 : 3



**PC 28-7771-01**



**PC 28-7772-02**

**Nugent**  
 10 cm/4"

- EN —● Strabismus, Muscle and Advancement Forceps
- DE —● Strabismus, Muskel-und Advancement Zange
- ES —● Estrabismo, los músculos y Promoción Pinzas

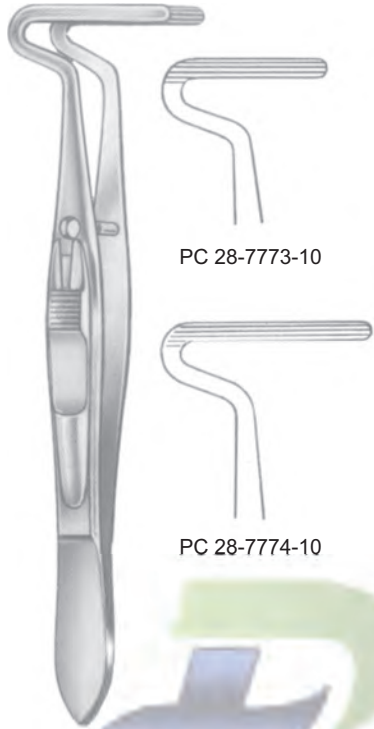

PC 28-7773-10

PC 28-7774-10

**Berke**  
10 cm/4"



**Blascovics**  
PC 28-7775-09  
9 cm/3 1/2"



**Blascovics**  
PC 28-7776-09  
9 cm/3 1/2"



**Worth**  
PC 28-7777-10  
10 cm/4"



**Worth**  
PC 28-7778-10  
10 cm/4"



**Jameson**  
PC 28-7779-10  
10 cm/4"



**Jameson**  
PC 28-7780-10  
10 cm/4"



**Prince**  
PC 28-7781-10  
10 cm/4"



**Prince**  
PC 28-7782-10  
10 cm/4"

- Entropium, Anterior Chamber Forceps ●— EN
- Entropium, Vorderkammer Zange ●— DE
- Entropion, pinzas Cámara Anterior ●— ES



**Snellen**  
PC 28-7783-10  
10 cm/4"



**Snellen**  
PC 28-7784-10  
10 cm/4"



**Erhardt**  
PC 28-7785-09  
9 cm/3 1/2"



**Barraquer**  
PC 28-7786-05  
5.5 cm/2 1/4"

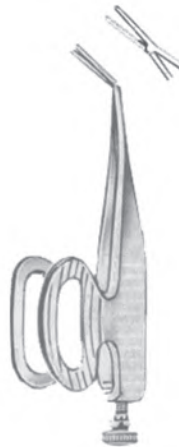

**Barraquer**  
PC 28-7787-05  
5.5 cm/2 1/4"



**Barraquer**  
PC 28-7788-05  
5.5 cm/2 1/4"



- EN —● Iris Forceps
- DE —● Iris Zange
- ES —● Iris Pinzas

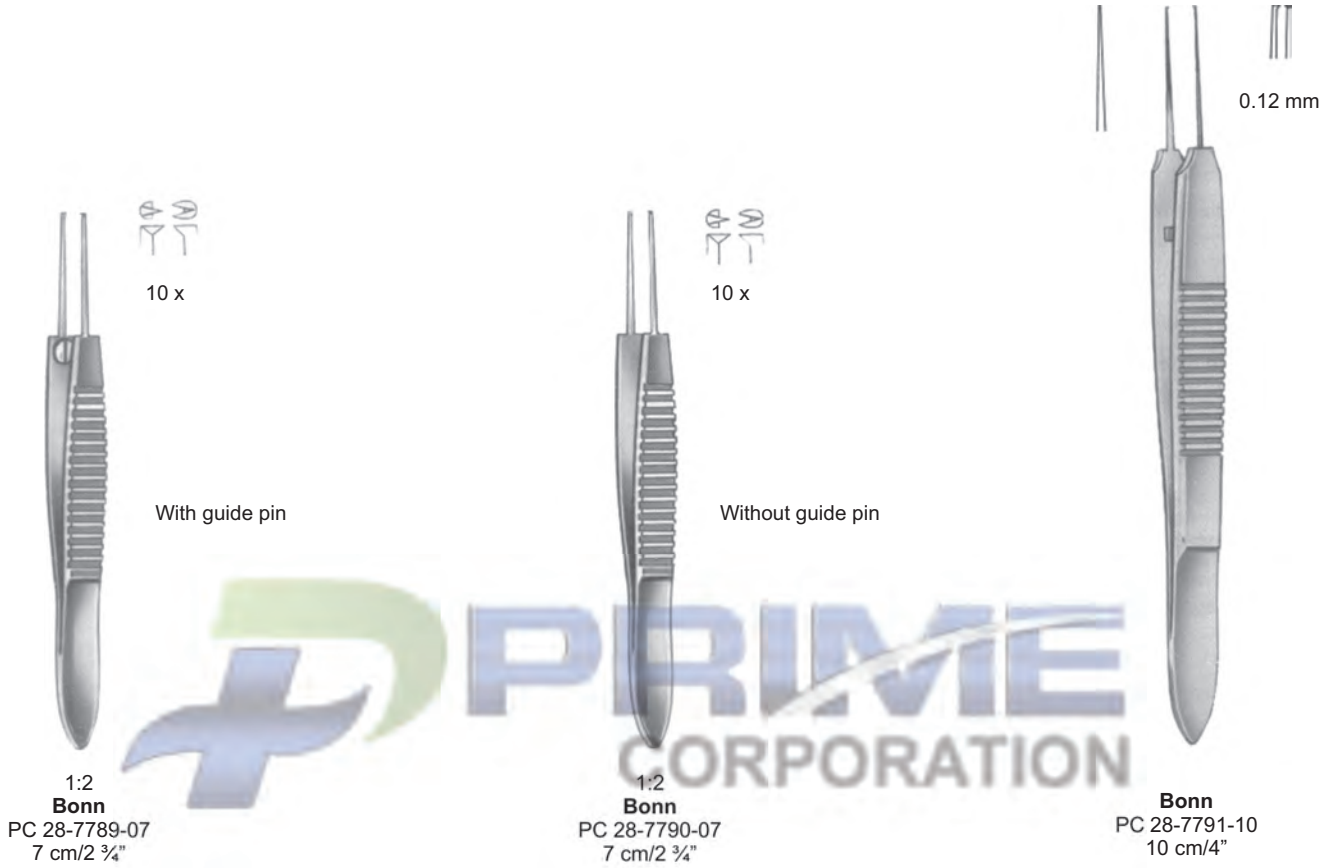

Iris Forceps ●— EN  
 Iris Zange ●— DE  
 Iris Pinzas ●— ES



**Graefe**  
10 cm/4"



PC 28-7796-10



PC 28-7797-10



PC 28-7798-10



PC 28-7799-10



PC 28-7800-10



PC 28-7801-10

Conjunctival forceps



**Stevens**  
10.5 cm/4¼"



PC 28-7802-10



PC 28-7803-10



PC 28-7804-10



PC 28-7805-10



PC 28-7806-10



PC 28-7807-10



**O'Connor**  
PC 28-7808-10  
10 cm/4"



**Stevens**  
PC 28-7809-11  
11 cm/4½"



**Stevens**  
PC 28-7810-11  
11 cm/4½"

- EN —● Iris, Fixation and Capsular Forceps
- DE —● Iris, Fixierung und Kapsel-Pinzetten
- ES —● Iris, la fijación y pinzas capsulares

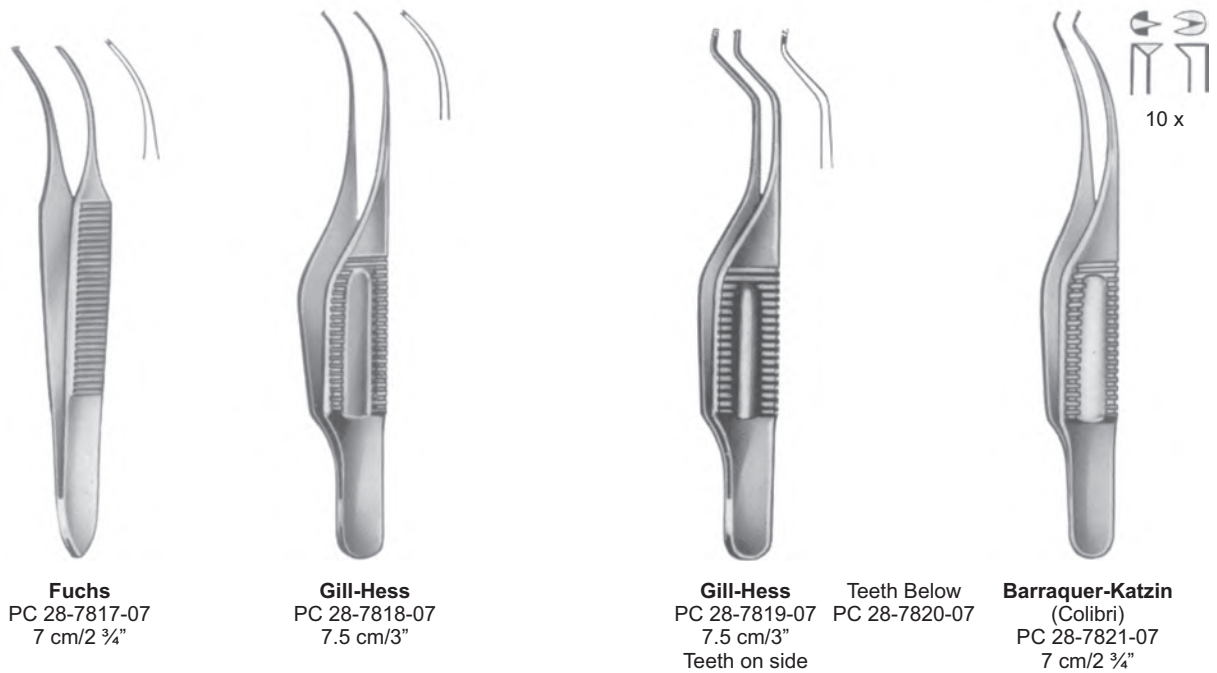
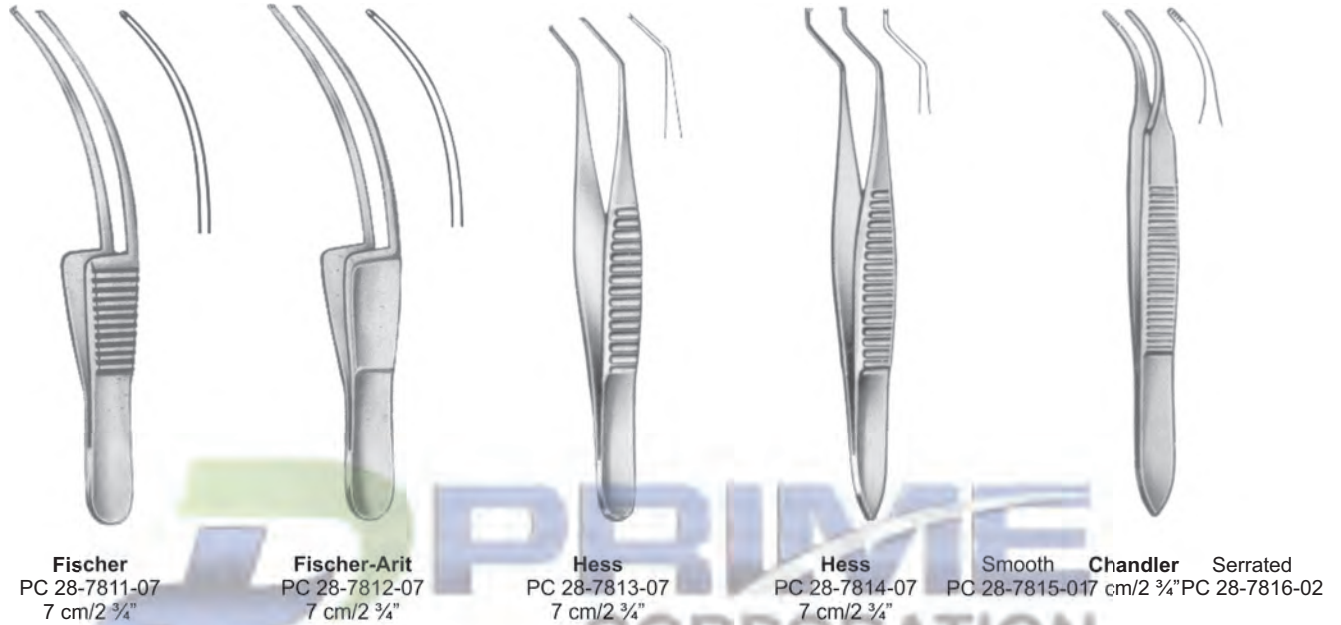

Capsular Forceps ●— EN  
 Kapsel-Pinzetten ●— DE  
 capsular Pinzas ●— ES



**Fuchs**  
PC 28-7822-07  
7 cm/2 ¾"

**Kalt**  
PC 28-7823-10  
10 cm/4"

**Terson**  
PC 28-7824-09  
9.5 cm/3 ¾"

**Arruga-Nizetic**  
PC 28-7825-10  
10 cm/4"

**Castroviejo**  
PC 28-7826-10  
10 cm/4"



**Castroviejo**  
PC 28-7827-10  
10 cm/4"



**Elschnig**  
PC 28-7828-10  
10 cm/4"

For Len Implantation



**Binkhorst**  
PC 28-7829-07  
7 cm/2 ¾"



**Arruga**  
PC 28-7830-09  
9.5 cm/3 ¾"



**Arruga**  
PC 28-7831-09  
9.5 cm/3 ¾"

- EN —● Trochoma and Chalazion Forceps
- DE —● Trochoma und Chalazion Zange
- ES —● Trochoma y Chalazión Pinzas



**Knapp**  
PC 28-7832-11  
11 cm/4¼"



**Ayer**  
PC 28-7833-09  
9 cm/3½"



**Ayer**  
PC 28-7834-09  
9 cm/3½"



**Lambert**  
PC 28-7835-09  
9 cm/3½"



**Desmarres**  
9 cm/3½"



PC 28-7836-01



PC 28-7837-02



PC 28-7838-03



Iridectomy Scissors ●— EN  
 Iridektomie Scissors ●— DE  
 Tijeras iridectomia ●— ES



Fig. 1



Fig. 2



Fig. 3



**Noyes**  
PC 28-7840-12  
12 cm/4 3/4"



**Wecker**  
11.5 cm/4 1/2"



PC 28-7841-01



PC 28-7842-02



**Barraquer**  
PC 28-7843-05  
5.5 cm/2 1/4"

**Noyes**  
Fig.1 PC 28-7839-01  
Fig.2 PC 28-7839-02  
Fig.3 PC 28-7839-03  
12 cm/4 3/4"



PC 28-7844-09  
9 cm/3 1/2"



PC 28-7845-09



PC 28-7846-09



PC 28-7847-09



PC 28-7848-09



PC 28-7849-09

- EN —● Iridectomy Scissors
- DE —● Iridektomie Scissors
- ES —● Tijeras iridectomia



**Vannas**  
PC 28-7850-08  
8 cm/3 1/4"



**Vannas**  
PC 28-7851-08  
8 cm/3 1/4"

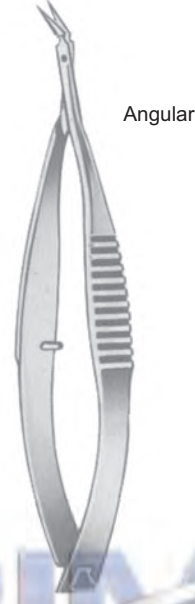

**Vannas**  
PC 28-7852-08  
8 cm/3 1/4"

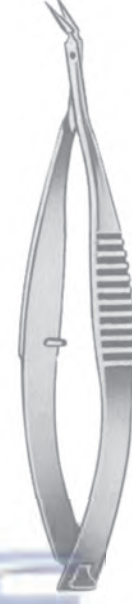

**Vannas**  
PC 28-7853-08  
8 cm/3 1/4"



PC 28-7854-08  
8.5 cm/3 1/4"



**Vannas Mod, Tubingen**  
PC 28-7855-08  
8.5 cm/3 1/4"



PC 28-7856-08  
8.5 cm/3 1/4"



PC 28-7857-08  
8.5 cm/3 1/4"

Iridectomy Scissors ● EN  
 Iridektomie Scissors ● DE  
 Tijeras iridectomia ● ES



PC 28-7858-10  
10 cm/4"



PC 28-7859-10  
10 cm/4"



Castroviejo  
PC 28-7860-10  
10 cm/4"



Castroviejo  
PC 28-7861-10  
10 cm/4"



Aebli  
PC 28-7862-10  
10 cm/4"



Castroviejo  
PC 28-7863-10  
10 cm/4"



Castroviejo  
PC 28-7864-10  
10 cm/4"

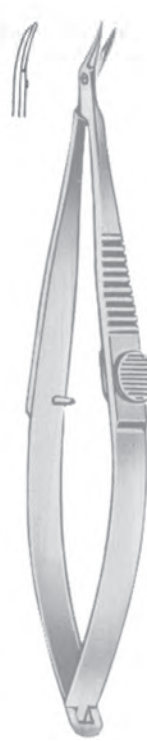

Troutman-Barraquer  
PC 28-7865-10  
10 cm/4"



Troutman-Barraquer  
PC 28-7866-10  
10 cm/4"

- EN —● Micro Scissors
- DE —● Mikro-Scheren
- ES —● Micro-Tijeras

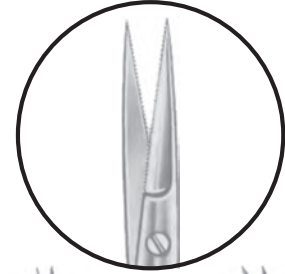

Saw Edge



Straight  
PC 28-7867-16  
16cm/6 1/4"

Curved  
PC 28-7868-16  
16cm/6 1/4"

Straight  
PC 28-7869-16  
16cm/6 1/4"

Curved  
PC 28-7870-16  
16cm/6 1/4"

**Millesi**  
Straight  
PC 28-7871-16  
16cm/6 1/4"

**Millesi**  
Curved  
PC 28-7872-16  
16cm/6 1/4"



- Micro Scissors ● EN
- Mikro-Scheren ● DE
- Micro-Tijeras ● ES



Straight  
PC 28-7873-18  
18.5cm/7 ¼"



Curved  
PC 28-7874-18  
18.5cm/7 ¼"



Angular  
PC 28-7875-18  
18.5cm/7 ¼"



Straight  
PC 28-7876-23  
23cm/9"



- EN —● Micro Scissors  
 DE —● Mikro-Scheren  
 ES —● Micro-Tijeras

## Dissecting Scissors



Straight  
 PC 28-7877-14  
 14.5cm/5 3/4"



Curved  
 PC 28-7878-14  
 14.5cm/5 3/4"



Curved  
 PC 28-7879-14  
 14.5cm/5 3/4"

**EN** Gynecology

**DE** Gynäkologie

**ES** Ginecología

Page 682 to 722



EN —● Vaginal Speculas  
 DE —● Scheidenspekula  
 ES —● Espéculos vaginales



**CUSCO**

- PC 29-8001-01 75 x 17mm
- PC 29-8001-02 75 x 32mm
- PC 29-8001-03 85 x 35mm
- PC 29-8001-04 100 x 37mm

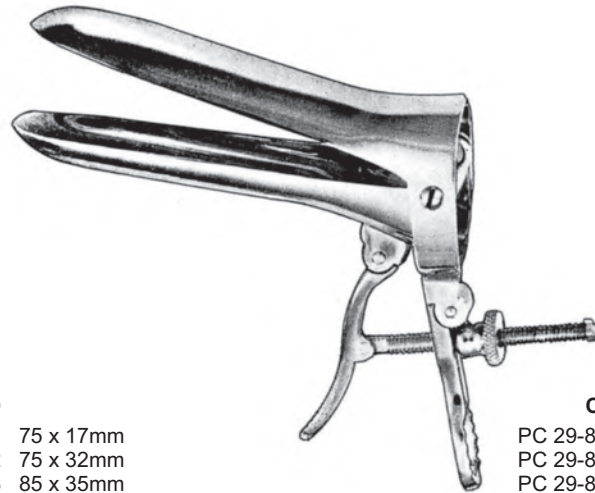

**CUSCO**

- PC 29-8002-01 75 x 17mm
- PC 29-8002-02 75 x 32mm
- PC 29-8002-03 80 x 32mm
- PC 29-8002-04 85 x 35mm
- PC 29-8002-05 110 x 35mm
- PC 29-8002-06 115 x 37mm



**CUSCO**

- PC 29-8003-01 75 x 32mm
- PC 29-8003-02 85 x 35mm
- PC 29-8003-03 100 x 35mm
- PC 29-8003-04 85 x 35mm ( with cold light carrier)
- PC 29-8003-05 (cold light carrier only)



**CUSCO**

- PC 29-8004-01 75 x 17mm
- PC 29-8004-02 85 x 17mm
- PC 29-8004-03 100 x 17mm



**CUSCO (Swiss pattern)**

- PC 29-8005-01 80 x 22mm
- PC 29-8005-02 100 x 25mm
- PC 29-8005-03 105 x 27mm
- PC 29-8005-04 115 x 27mm



**CUSCO'S**

- PC 29-8006-01 (LL)
- PC 29-8006-02 (L)
- PC 29-8006-03 (M)
- PC 29-8006-04 (S)
- PC 29-8006-05 (SS)
- PC 29-8006-06 (SSS)

Vaginal Speculas ● EN  
 Scheidenspekula ● DE  
 Esfécúlos vaginales ● ES



for children

**COLLIN**  
 PC 29-8007-01 55 x 10mm



**COLLIN**  
 PC 29-8007-02 65 x 20mm



**Collin-Landau**  
 Medium PC 29-8007-03 35 x 100 mm



**Collin**  
 Small PC 29-8007-12 30 x 85 mm  
 Medium PC 29-8007-13 35 x 100 mm  
 Large PC 29-8007-14 40 x 110 mm

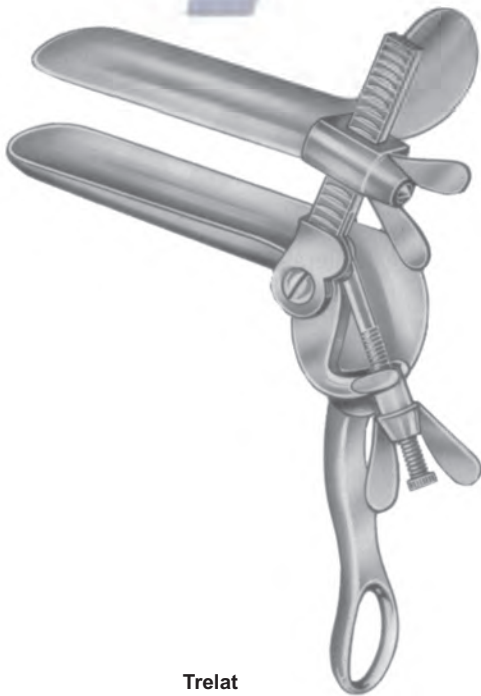

**Trelat**

	a	b
	mm	mm
PC 29-8008-01	85	33
PC 29-8008-02	95	35
PC 29-8008-03	115	43



**Grave (Standard)**

	a	b
	mm	mm
PC 29-8009-01	75	20
PC 29-8009-02	95	35
PC 29-8009-03	115	35
PC 29-8009-04	125	35

- EN —● Vaginal Speculas
- DE —● Scheidenspekula
- ES —● Espéculos vaginales



Black



Grave	a mm	b mm
PC 29-8010-01	75	20
PC 29-8010-02	95	35
PC 29-8010-03	115	35
PC 29-8010-04	130	25

Grave	a mm	b mm
Angled 135°		
PC 29-8011-00	101	35

Fergusson	
PC 29-8011-01	25mm Ø
PC 29-8011-02	30mm Ø
PC 29-8011-03	35mm Ø
PC 29-8011-04	40mm Ø

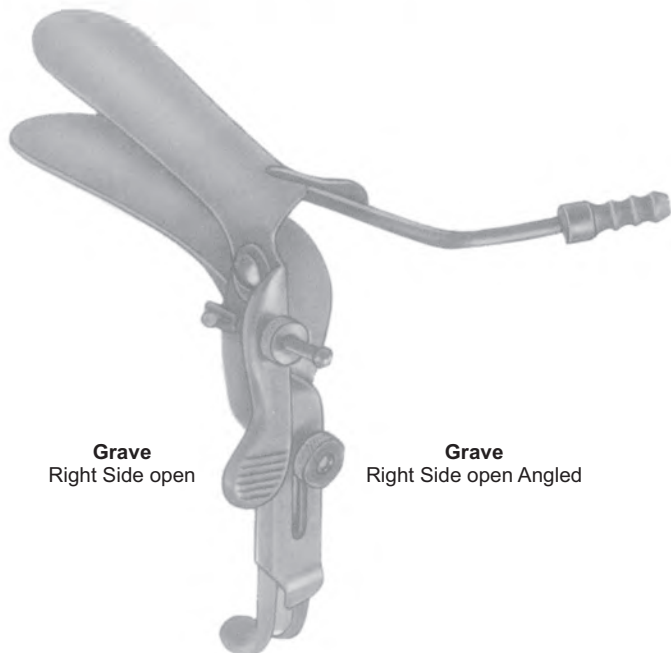

Grave  
Right Side open

Grave  
Right Side open Angled

	a mm	b mm
PC 29-8012-01	101	35
PC 29-8012-02		

Lateral Specula



PC 29-8013-00



Vaginal Speculas ●— EN  
 Scheidenspekula ●— DE  
 Espécúlos vaginales ●— ES



**Pederson**

	a	b
	mm	mm
PC 29-8014-01	75	13
PC 29-8014-02	100	22
PC 29-8014-03	120	25
PC 29-8014-04	130	25

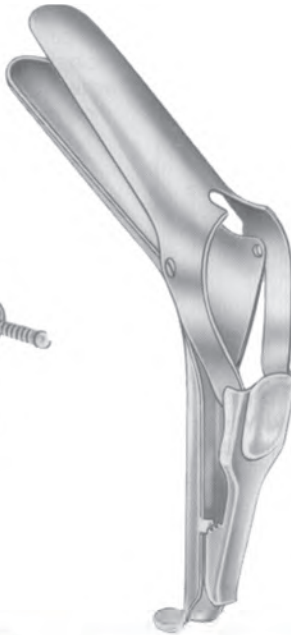

**Semm**

	a	b
	mm	mm
PC 29-8015-01	90	14/18
PC 29-8015-02	100	17/20
PC 29-8015-03	100	25/30

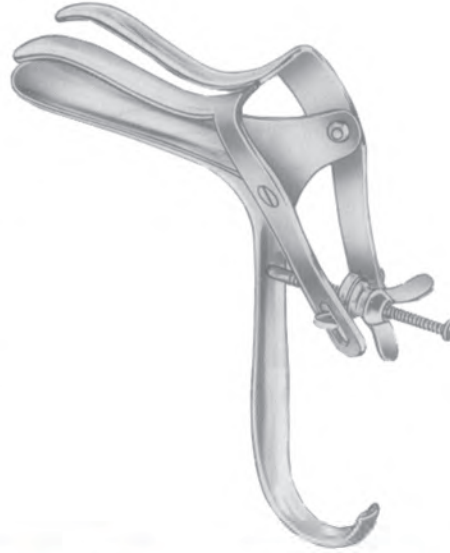

**Nott**

	a	b
	mm	mm
PC 29-8016-01	90	30
PC 29-8016-02	110	30



**Seyffert**

	a	b
	mm	mm
PC 29-8017-01	100	17
PC 29-8017-02	110	33

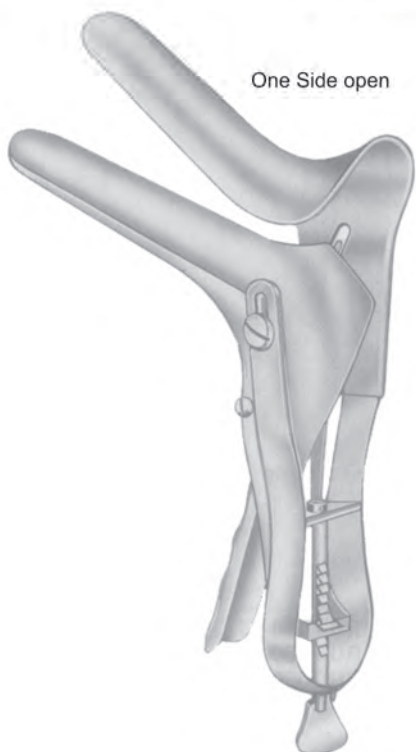

One Side open

**Seyffert**

	a	b
	mm	mm
PC 29-8018-00	110	33



**SAKURAI'S**

PC 29-8018-01 (LL)
PC 29-8018-02 (L)
PC 29-8018-03 (M)
PC 29-8018-04 (S)

- EN —● Vaginal Speculas
- DE —● Scheidenspekula
- ES —● Espéculos vaginales



**Sims (single ended)**  
 PC 29-8019-01 63 x 32 mm  
 PC 29-8019-02 76 x 32 mm  
 PC 29-8019-03 89 x 38 mm



**Sims (double ended)**  
 PC 29-8020-01 65 x 25 mm (70 x 30 mm)  
 PC 29-8020-02 70 x 35 mm (70 x 35 mm)  
 PC 29-8020-03 85 x 35 mm (90 x 40 mm)  
 PC 29-8020-04 100 x 35 mm x 40 mm  
 PC 29-8020-05 120 x 35 mm x 40 mm



**SIMS**  
 PC 29-8020-11 60 x 25mm  
 PC 29-8020-12 70 x 30mm  
 PC 29-8020-13 80 x 35mm



**Jackson**

Fig.	a	b
	mm	mm
PC 29-8021-01	1	75 X 35
PC 29-8021-02	2	90 X 35
PC 29-8021-03	3	100 X 35
PC 29-8021-04	4	75 X 40
PC 29-8021-05	5	90 x 40
PC 29-8021-06	6	100 x 40



**Eastman**

Fig.	a	b
	mm	mm
PC 29-8022-01	1	75 X 35
PC 29-8022-02	2	90 X 35
PC 29-8022-03	3	100 X 35
PC 29-8022-04	4	75 X 40
PC 29-8022-05	5	90 x 40
PC 29-8022-06	6	100 x 40

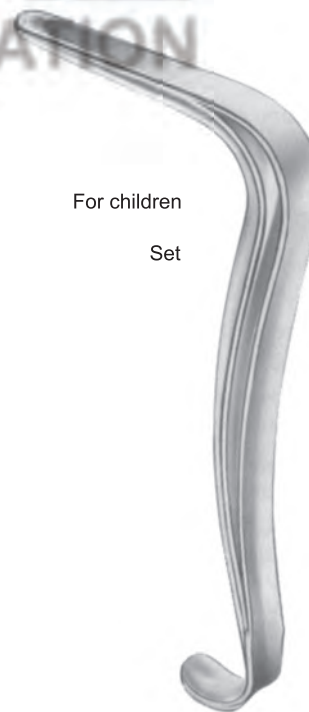

For children  
Set

**Kristeller**  
 PC 29-8023-00  
 70x15 mm

Vaginal Speculas ●— EN  
 Scheidenspekula ●— DE  
 Espéculos vaginales ●— ES

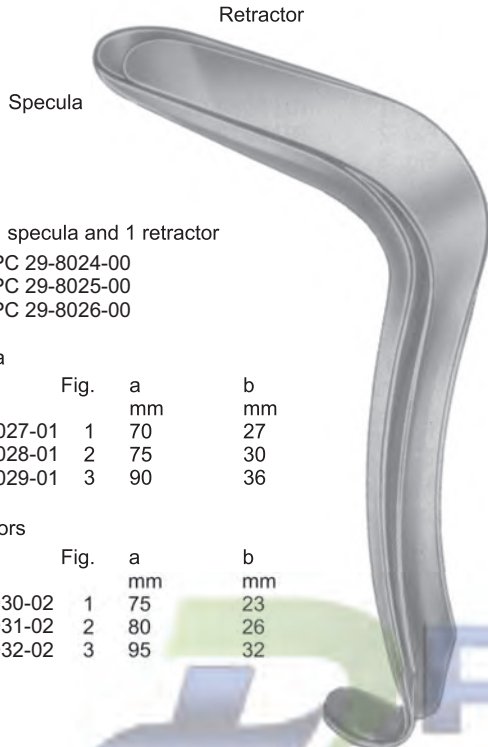

Retractor  
 Specula

Set of 1 specula and 1 retractor  
 Fig. 1 PC 29-8024-00  
 Fig. 2 PC 29-8025-00  
 Fig. 3 PC 29-8026-00

Specula

Fig.	a mm	b mm
PC 29-8027-01	1 70	27
PC 29-8028-01	2 75	30
PC 29-8029-01	3 90	36

Retractors

Fig.	a mm	b mm
PC 29-8030-02	1 75	23
PC 29-8031-02	2 80	26
PC 29-8032-02	3 95	32

Kristeller (Standard)

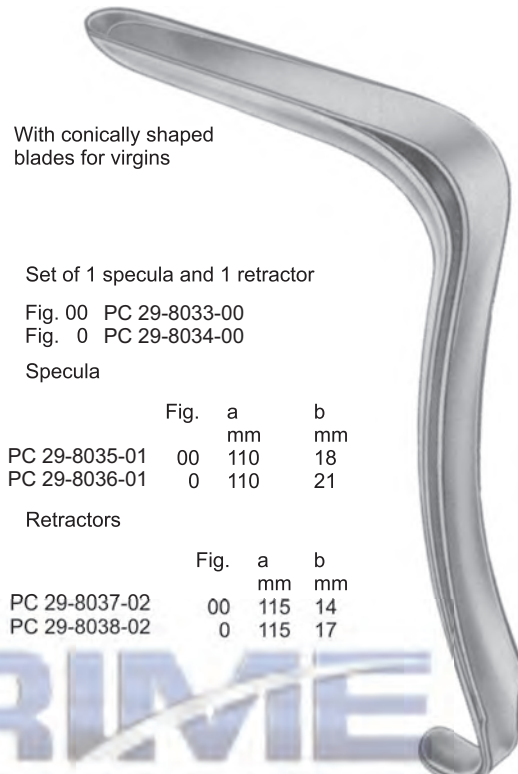

With conically shaped blades for virgins

Set of 1 specula and 1 retractor  
 Fig. 00 PC 29-8033-00  
 Fig. 0 PC 29-8034-00

Specula

Fig.	a mm	b mm
PC 29-8035-01	00 110	18
PC 29-8036-01	0 110	21

Retractors

Fig.	a mm	b mm
PC 29-8037-02	00 115	14
PC 29-8038-02	0 115	17

Kristeller

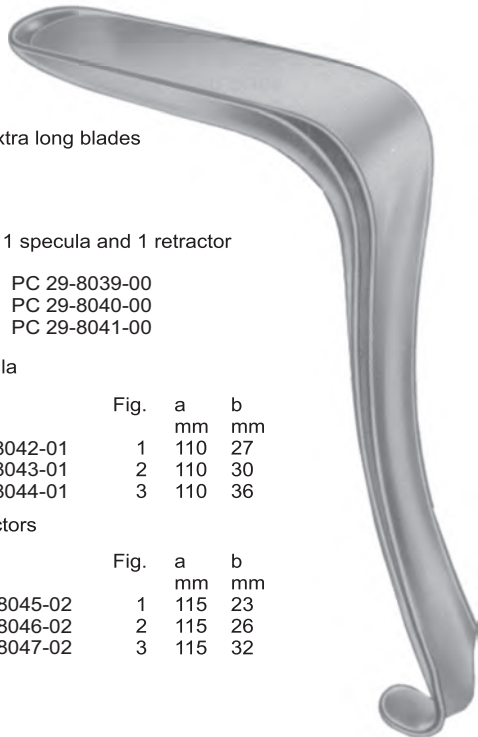

With extra long blades

Set of 1 specula and 1 retractor  
 Fig. 1 PC 29-8039-00  
 Fig. 2 PC 29-8040-00  
 Fig. 3 PC 29-8041-00

Specula

Fig.	a mm	b mm
PC 29-8042-01	1 110	27
PC 29-8043-01	2 110	30
PC 29-8044-01	3 110	36

Retractors

Fig.	a mm	b mm
PC 29-8045-02	1 115	23
PC 29-8046-02	2 115	26
PC 29-8047-02	3 115	32

Kristeller (Standard)

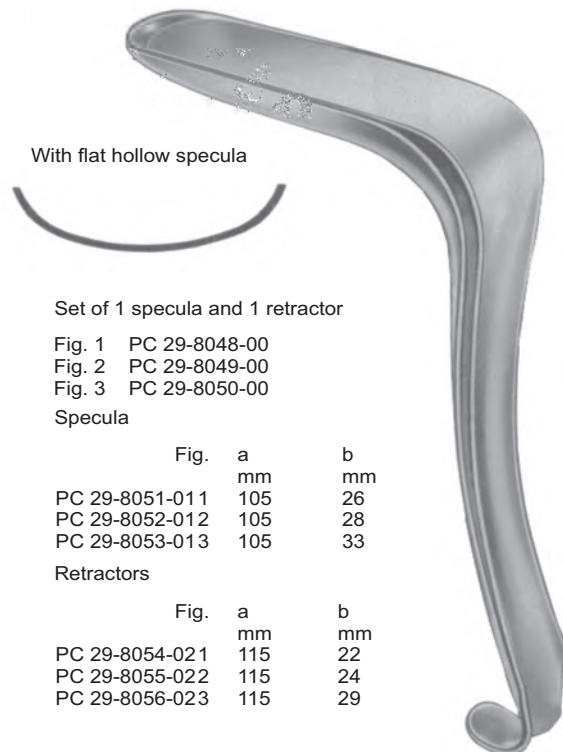

With flat hollow specula

Set of 1 specula and 1 retractor  
 Fig. 1 PC 29-8048-00  
 Fig. 2 PC 29-8049-00  
 Fig. 3 PC 29-8050-00

Specula

Fig.	a mm	b mm
PC 29-8051-011	105	26
PC 29-8052-012	105	28
PC 29-8053-013	105	33

Retractors

Fig.	a mm	b mm
PC 29-8054-021	115	22
PC 29-8055-022	115	24
PC 29-8056-023	115	29

Kristeller

EN —● Vaginal Speculas and Retractors  
 DE —● Scheidenspekula und -halter  
 ES —● Espéculos y Valvas vaginales

	a	b
	mm	mm
PC 29-8057-20	100	20
PC 29-8057-25	100	25
PC 29-8057-30	100	30
PC 29-8057-35	100	35
PC 29-8057-40	100	40
PC 29-8058-20	130	20
PC 29-8058-25	130	25
PC 29-8058-30	130	30
PC 29-8058-35	130	35
PC 29-8058-40	130	40

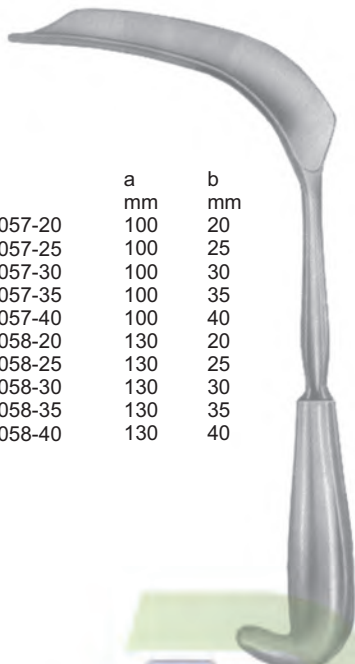

**Matzenauer**



**Braun**  
 PC 29-8059-18  
 18 cm/7"  
 56x13 mm



**Braun**  
 PC 29-8060-18  
 18 cm/7"  
 60x10 mm



**Ulrich**  
 PC 29-8061-19  
 19.5 cm/7 1/2"  
 80x20 mm



**PC 29-8062-19**  
 19 cm/7 1/2"  
 85x17 mm

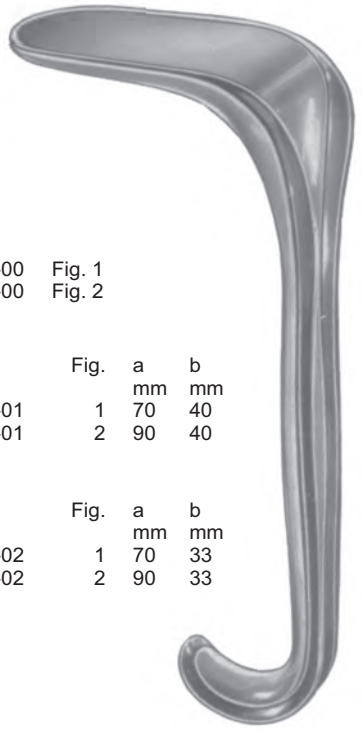

**Kallmorgen**

Set		Fig.	a	b
			mm	mm
PC 29-8063-00	Fig. 1			
PC 29-8064-00	Fig. 2			
Specula				
	Fig.	a	b	
		mm	mm	
PC 29-8065-01	1	70	40	
PC 29-8066-01	2	90	40	
Retractors				
	Fig.	a	b	
		mm	mm	
PC 29-8067-02	1	70	33	
PC 29-8068-02	2	90	33	



Vaginal Speculas and Retractors ● EN  
 Scheidenspekula und -halter ● DE  
 Espéculos y Valvas vaginales ● ES



Specula				Retractors				Doyen			
	Fig.	a	b		Fig.	a	b		Fig.	a	b
	Set	mm	mm		Set	mm	mm			mm	mm
PC 29-8069-00				PC 29-8070-00				PC 29-8071-01	1	75	45
PC 29-8069-01	1	100	13/23	PC 29-8070-01	1	100	11/21	PC 29-8071-02	2	90	45
PC 29-8069-02	2	100	16/30	PC 29-8070-02	2	100	14/27	PC 29-8071-03	3	110	45
								PC 29-8072-01			75 x 280mm
								PC 29-8072-02			90 x 280mm
								PC 29-8072-03			100 x 280mm
								PC 29-8072-04			115 x 280mm



PC 29-8073-14 140 x 30mm      PC 29-8074-13 135 x 36mm      PC 29-8074-14 140 x 36mm



EN —● Vaginal Speculas  
 DE —● Scheidenspekula  
 ES —● Espéculos vaginales

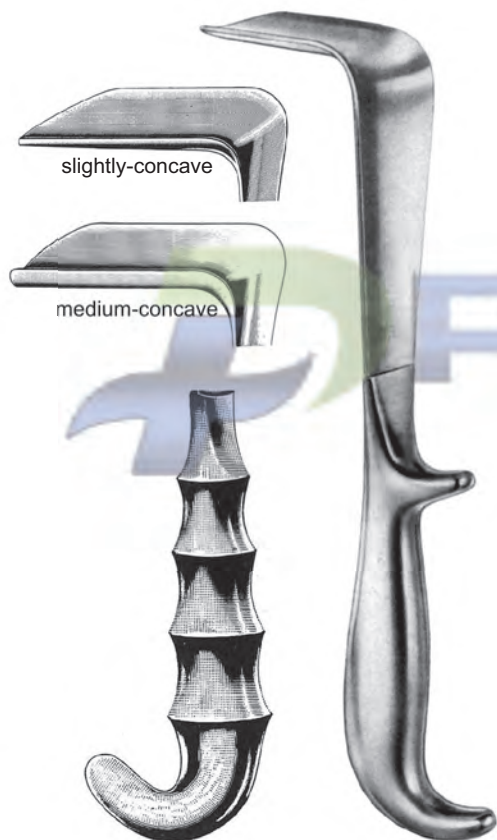
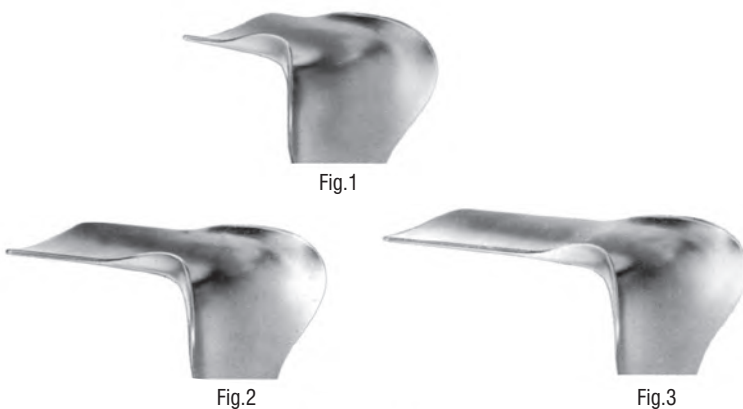
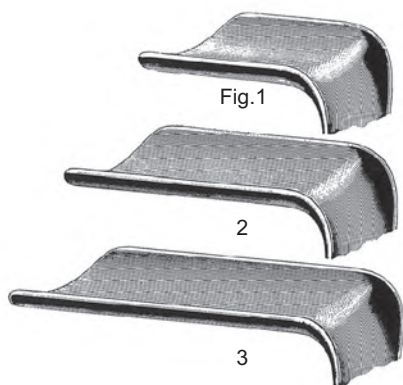

Fig	DOYEN FG		DOYEN		
	mm	mm	slightly-concave	slightly-concave	medium-concave
1	55	35	PC 29-8075-11	PC 29-8075-01	PC 29-8078-01
2	85	35	PC 29-8075-12	PC 29-8075-02	PC 29-8078-02
3	115	35	PC 29-8075-13	PC 29-8075-03	PC 29-8078-03
1	55	45	PC 29-8076-11	PC 29-8076-01	PC 29-8079-01
2	85	45	PC 29-8076-12	PC 29-8076-02	PC 29-8079-02
3	115	45	PC 29-8076-13	PC 29-8076-03	PC 29-8079-03
1	55	60	PC 29-8077-11	PC 29-8077-01	PC 29-8080-01
2	85	60	PC 29-8077-12	PC 29-8077-02	PC 29-8080-02
3	115	60	PC 29-8077-13	PC 29-8077-03	PC 29-8080-03

**DOYEN**  
 PC 29-8080-11 75 x 45mm  
 PC 29-8080-12 90 x 45mm  
 PC 29-8080-13 110 x 45mm

**Doyen**  
 25 cm/10"

	a	b
	mm	mm
PC 29-8081-01	60	30
PC 29-8081-02	70	30
PC 29-8081-03	80	30

Vaginal Speculas — EN  
 Scheidenspekula — DE  
 Espéculos vaginales — ES



**AUVARD**  
 PC 29-8082-01 80 x 38mm 2 lbs  
 PC 29-8082-02 80 x 38mm 2.5 lbs  
 PC 29-8082-03 80 x 38mm 3 lbs

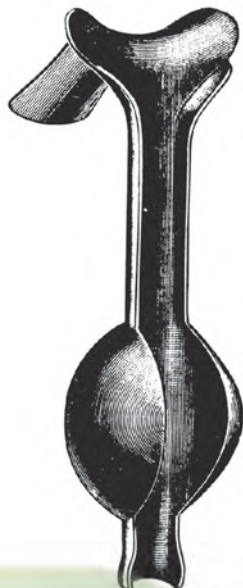

**AUVARD**  
 PC 29-8082-00 68 x 40mm 3 lbs



80 x 38 mm

**AUVARD**  
 PC 29-8082-04 2.5 lbs  
 PC 29-8082-05 3 lbs

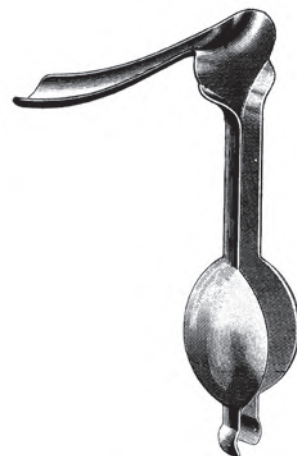

**Steiner-Auvard**  
 PC 29-8083-01 140 x 35mm 2.5 lbs  
 PC 29-8083-02 140 x 35mm 2.5 lbs  
 laser pattern



**Henrotin**  
 PC 29-8083-03 80 x 35mm 3 lbs  
 30° blade angled down



**Landau**

	a	b
	mm	mm
PC 29-8084-01	105	28
PC 29-8084-02	105	38



**Dunkel**  
 PC 29-8084-22



**Breisky**

	a	b
	mm	mm
PC 29-8085-20	100	20
PC 29-8085-25	100	25
PC 29-8085-30	100	30
PC 29-8085-35	100	35
PC 29-8085-40	100	40
PC 29-8086-20	130	20
PC 29-8086-25	130	25
PC 29-8086-30	130	30
PC 29-8086-35	130	35
PC 29-8086-40	130	40
PC 29-8087-20	160	20
PC 29-8087-25	160	25
PC 29-8087-30	160	30
PC 29-8087-35	160	35
PC 29-8087-40	160	40
PC 29-8088-20	180	20
PC 29-8088-25	180	25
PC 29-8088-30	180	30
PC 29-8088-35	180	35
PC 29-8088-40	180	40
PC 29-8088-50	155	40



**Berlind-Auvard**  
 PC 29-8083-04  
 105 x 40mm 2.5 lbs

- EN —● Retractors
- DE —● Wundspreizer
- ES —● Separadores



**BOZEMANN**

- PC 29-8089-20 compl. set with handle A, B and 8 blades
- PC 29-8089-30 compl. set with handle A and 8 blades
- PC 29-8089-40 compl. set with handle B and 8 blades



**Friedman**  
PC 29-8090-20  
10 cm/4"

**Comyn Berkeley**  
Vulva self retaining  
PC 29-8090-15  
15.5cm/6"

**Joll**  
Thyroid self retaining  
PC 29-8091-15  
15.5cm/6"



- Lateral Wall Retractors ● EN
- Wundspreizer ● DE
- Separadores ● ES

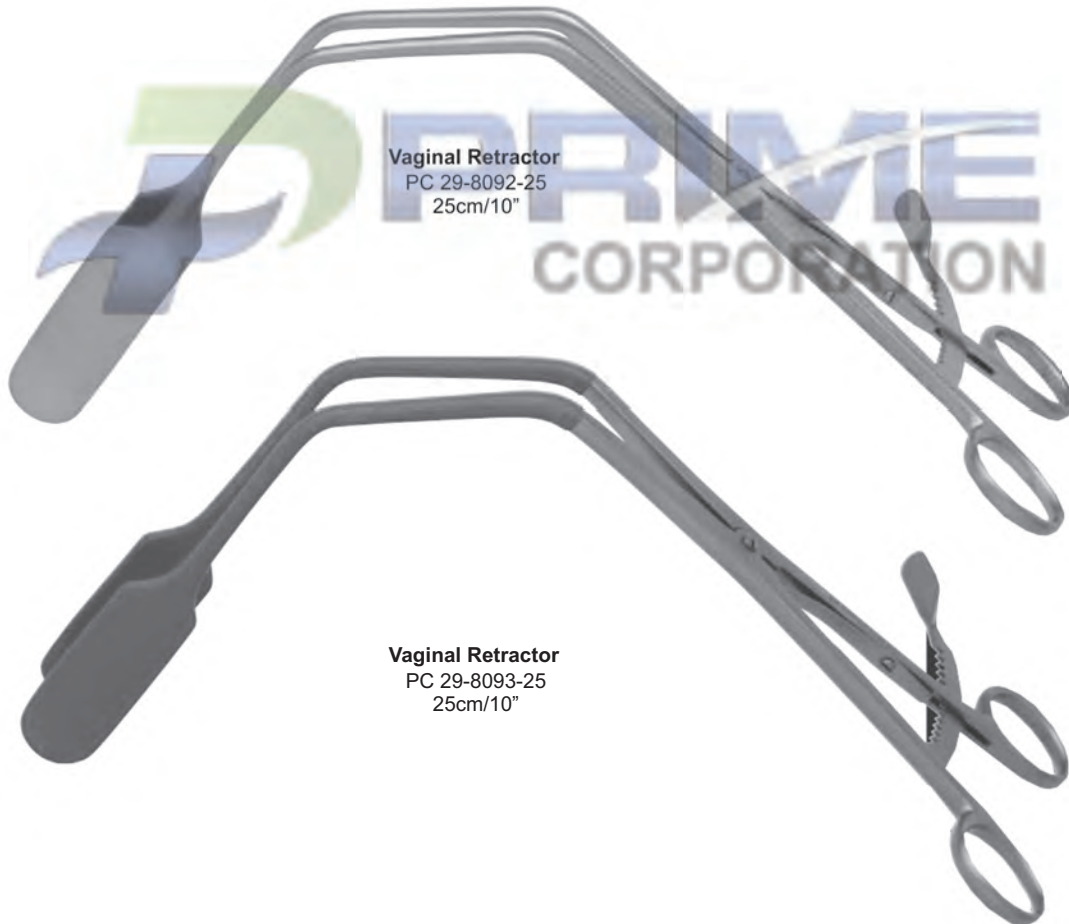
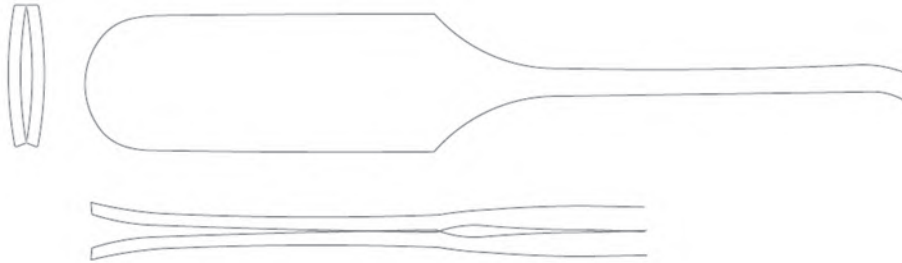

- EN —● Vaginal Speculas and Retractors
- DE —● Scheidenspekula und -halter
- ES —● Espéculos y Valvas vaginales



**Scherbak**  
 PC 29-8094-00 Complete  
 PC 29-8094-10 Handle only



PC 29-8094-01  
 80x30 mm



PC 29-8094-02  
 85x35 mm



PC 29-8094-03  
 90x40 mm



PC 29-8094-04  
 55x40/60 mm



PC 29-8094-05  
 70x45/70 mm



Fig.	a	b
	mm	mm
PC 29-8095-01 1	45	17
PC 29-8095-02 2	90	37
PC 29-8095-03 3	90	45

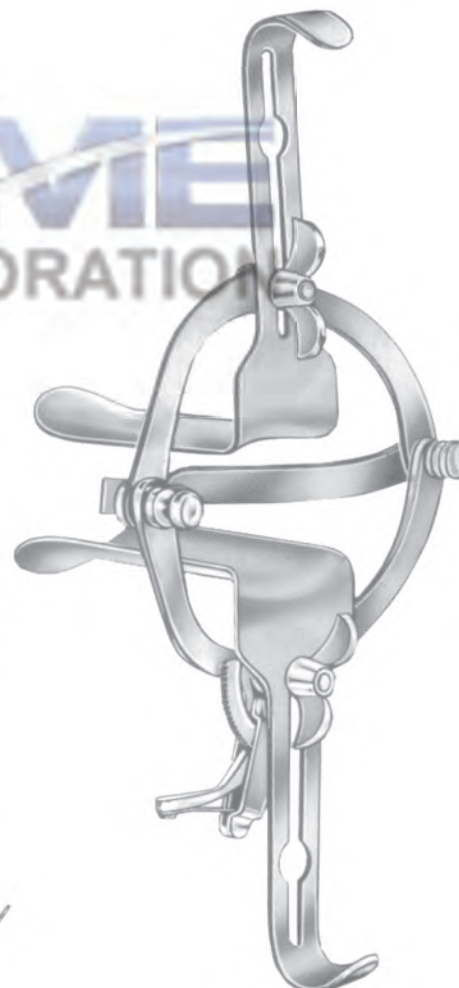

**O'Sullivan-O'Connor**  
 PC 29-8095-00  
 Complete



Uterine Dilators ●— EN  
 Uterus-Dilatatoren ●— DE  
 Dilatadores uterinos ●— ES



**Hegar**  
single ended  
18.5 cm long

mm Ø	PC 29-8096-01	PC 29-8096-51	mm dia.
1.0	PC 29-8096-01	PC 29-8096-51	1.5
2.0	PC 29-8096-02	PC 29-8096-52	2.5
3.0	PC 29-8096-03	PC 29-8096-53	3.5
4.0	PC 29-8096-04	PC 29-8096-54	4.5
5.0	PC 29-8096-05	PC 29-8096-55	5.5
6.0	PC 29-8096-06	PC 29-8096-56	6.5
7.0	PC 29-8096-07	PC 29-8096-57	7.5
8.0	PC 29-8096-08	PC 29-8096-58	8.5
9.0	PC 29-8096-09	PC 29-8096-59	9.5
10.0	PC 29-8096-10	PC 29-8096-60	10.5
11.0	PC 29-8096-11	PC 29-8096-61	11.5
12.0	PC 29-8096-12	PC 29-8096-62	12.5
13.0	PC 29-8096-13	PC 29-8096-63	13.5
14.0	PC 29-8096-14	PC 29-8096-64	14.5
15.0	PC 29-8096-15	PC 29-8096-65	15.5
16.0	PC 29-8096-16	PC 29-8096-66	16.5
17.0	PC 29-8096-17	PC 29-8096-67	17.5
18.0	PC 29-8096-18	PC 29-8096-68	18.5
19.0	PC 29-8096-19	PC 29-8096-69	19.5
20.0	PC 29-8096-20	PC 29-8096-70	20.5
21.0	PC 29-8096-21	PC 29-8096-71	21.5
22.0	PC 29-8096-22	PC 29-8096-72	22.5
23.0	PC 29-8096-23	PC 29-8096-73	23.5
24.0	PC 29-8096-24	PC 29-8096-74	24.5
25.0	PC 29-8096-25	PC 29-8096-75	25.5
26.0	PC 29-8096-26	PC 29-8096-76	26.5
27.0	PC 29-8096-27	PC 29-8096-77	27.5
28.0	PC 29-8096-28	PC 29-8096-78	28.5
29.0	PC 29-8096-29	PC 29-8096-79	29.5
30.0	PC 29-8096-30	PC 29-8096-80	30.5



Pieces per set

PC 29-8097-10	14	4 - 17 mm
PC 29-8097-20	26	1 - 26 mm
PC 29-8097-30	30	1 - 30 mm

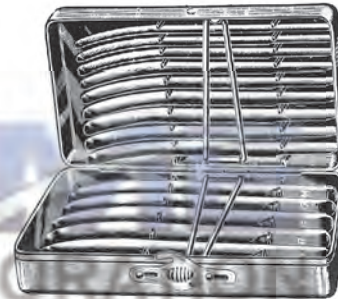

Pieces per set

PC 29-8098-40	14	4 - 17 mm
PC 29-8098-50	26	1 - 26 mm
PC 29-8098-60	30	1 - 30 mm



**Hegar**  
double ended  
20 cm long

Ø mm	PC 29-8099-02
1/2	PC 29-8099-02
3/4	PC 29-8099-04
5/6	PC 29-8099-06
7/8	PC 29-8099-08
9/10	PC 29-8099-10
11/12	PC 29-8099-12
13/14	PC 29-8099-14
15/16	PC 29-8099-16
17/18	PC 29-8099-18
19/20	PC 29-8099-20
21/22	PC 29-8099-22
23/24	PC 29-8099-24
25/26	PC 29-8099-26

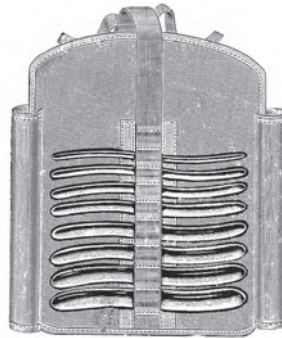

Pieces per set set

PC 29-8100-00	08	3/4 - 17/18 mm	PC 29-8100-30
PC 29-8100-01	13	1/2 - 25/26 mm	PC 29-8100-31

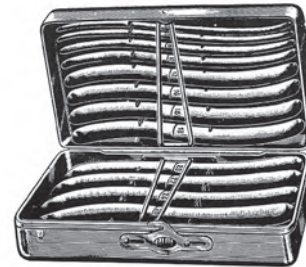

EN —● Uterine Dilators  
 DE —● Uterus-Dilatatoren  
 ES —● Dilatadores uterinos



mm	PC
3/6	PC 29-8102-03
4/7	PC 29-8102-04
5/8	PC 29-8102-05
6/9	PC 29-8102-06
7/10	PC 29-8102-07
8/11	PC 29-8102-08
9/12	PC 29-8102-09
10/13	PC 29-8102-10
11/14	PC 29-8102-11
12/15	PC 29-8102-12
13/16	PC 29-8102-13
14/17	PC 29-8102-14
15/18	PC 29-8102-15
16/19	PC 29-8102-16
17/20	PC 29-8102-17
18/21	PC 29-8102-18

**Hawkin Ambler**

PC 29-8101-12 Set of 12 3/6 - 14/17  
 PC 29-8101-16 Set of 16 3/6 - 18/21  
 17 cm long



**Hank**  
 PC 29-8103-30

mm	PC
9/10	PC 29-8104-10
11/12	PC 29-8104-12
13/14	PC 29-8104-14
15/16	PC 29-8104-16
17/18	PC 29-8104-18
19/20	PC 29-8104-20

Set  
 PC 29-8105-00  
 double ended  
 27 cm

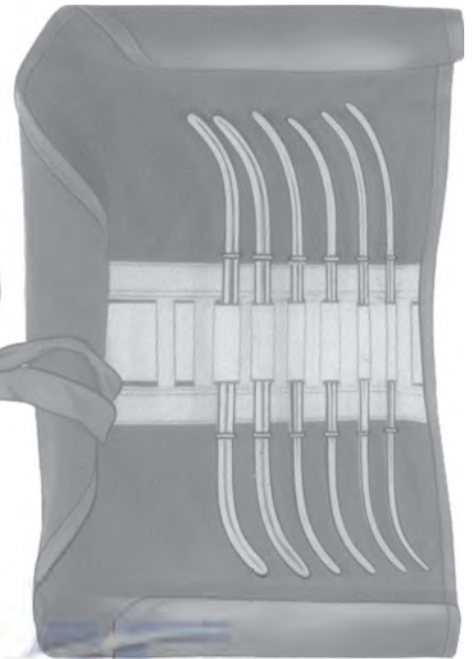

mm	PC
13/15	PC 29-8106-15
17/19	PC 29-8106-19
21/23	PC 29-8106-23
25/27	PC 29-8106-27
29/31	PC 29-8106-31
33/35	PC 29-8106-35
37/39	PC 29-8106-39
41/43	PC 29-8106-43

**Pratt**

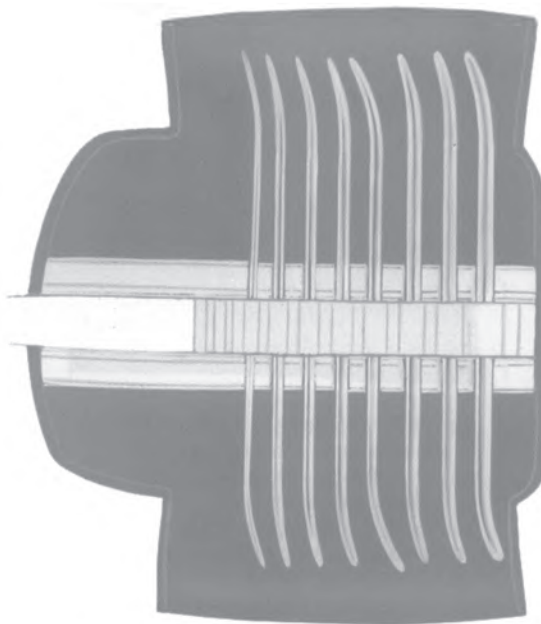

Set  
 PC 29-8106-00  
 double ended  
 29 cm



**Jolly**

PC 29-8107-00 set of 5  
 PC 29-8107-01 3-7 mm dia  
 PC 29-8107-02 5-9 mm dia  
 PC 29-8107-03 7-12 mm dia  
 PC 29-8107-04 9-15 mm dia  
 PC 29-8107-05 12-18 mm dia

Uterine Sounds and Depressors ●— EN  
 Uterussonden, -depressoren ●— DE  
 Histerómetros, Depresores uterinos ●— ES

Tip 4 mm

Uterine Depressor



	<b>Sims</b>	<b>Martin (Simpson)</b>	<b>Valleix</b>	<b>Collin</b>	<b>Braun</b>
	32 cm/12½"	32 cm/12½"	PC 29-8110-25	PC 29-8111-28	PC 29-8112-28
Rigid	cm PC 29-8108-01 s/s	cm PC 29-8109-01 s/s	25 cm/10"	28 cm/11"	28 cm/11"
Malleable	cm / in PC 29-8108-02 s/s PC 29-8108-03 c/p	cm / in PC 29-8109-02 s/s PC 29-8109-03 c/p			

- EN —● Uterine Dilators  
 DE —● Uterus-Dilatatoren  
 ES —● Dilataores uterinos

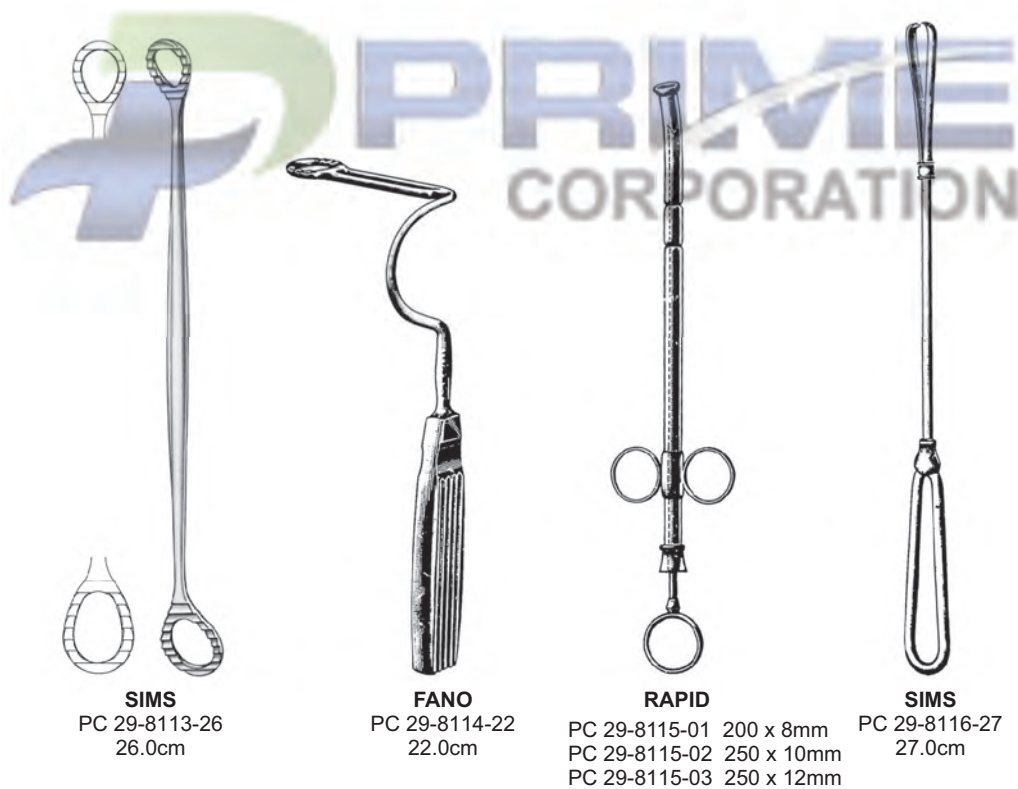



Uterine Sounds ● EN  
 Uterussonden ● DE  
 Histerómetros ● ES



<b>VALLEIX</b> PC 29-8117-25 25.0cm	<b>PC 29-8118-30</b> 30.5cm	<b>GALABIN</b> PC 29-8119-32 32.0cm	<b>HORROCKS</b> PC 29-8120-32 32.0cm	<b>SIMPSON</b> PC 29-8121-32 32.0cm
---	--------------------------------	---	--	---



- EN —● Laser Instruments
- DE —● Laser Instrumente
- ES —● Instrumentos láser

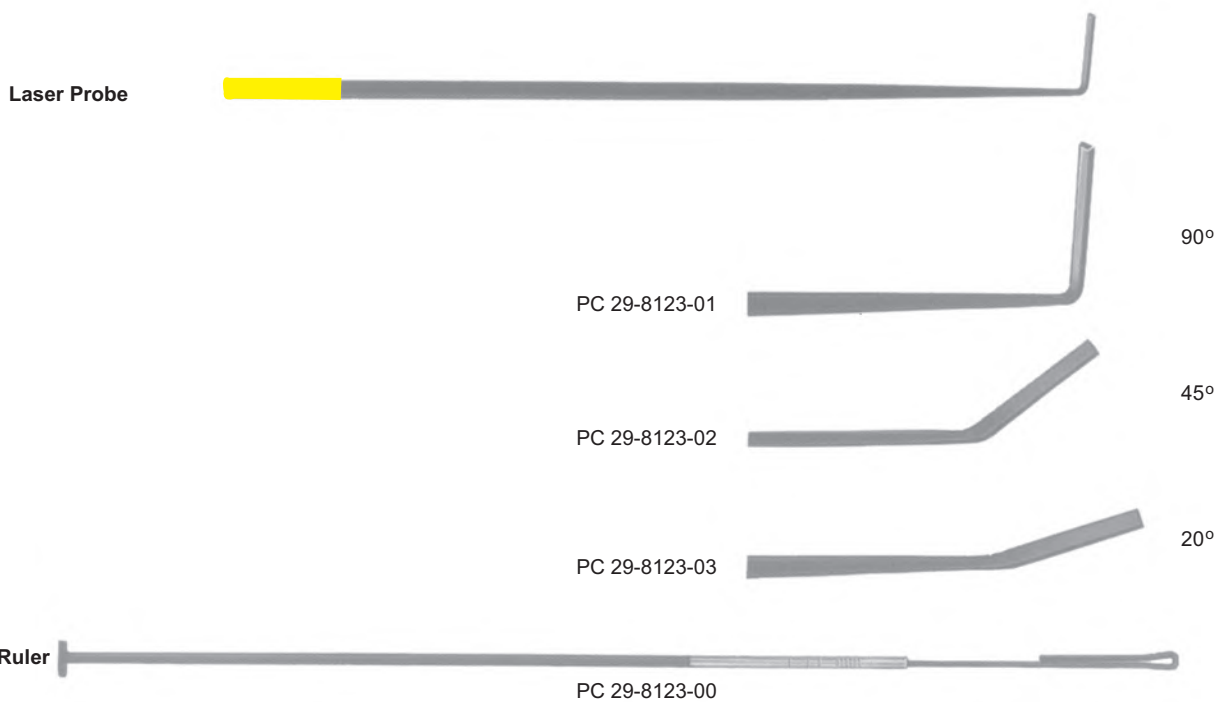
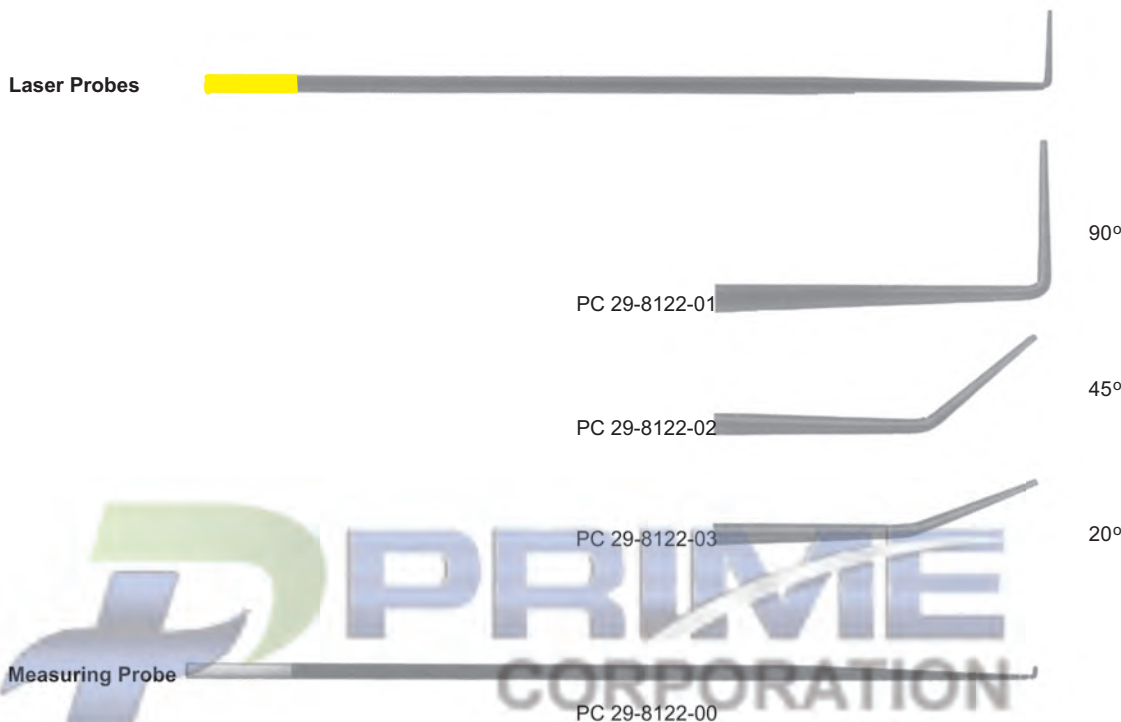

- Laser Instruments — EN
- Laser Instrumente — DE
- Instrumentos láser — ES

Measuring Instruments

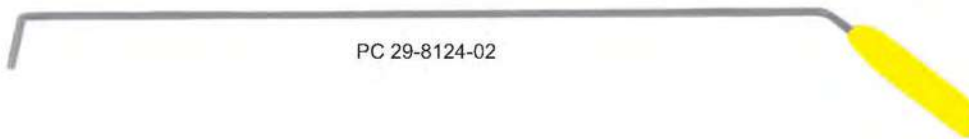

Hooks



PC 29-8125-02 Emmet

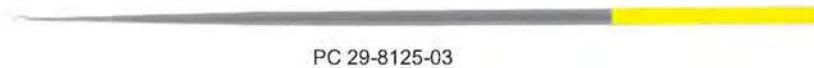

- EN —● Corn Knives, Fistula Hooks, Myoma Instruments
- DE —● Konusmesser, Fistelhaken, Myom-instrumente
- ES —● Bisturí p. conos de atraccion, Ganchos p. fistulas



**Ayre**  
PC 29-8128-23  
23 cm/9"

**Simon**  
PC 29-8129-22  
22 cm/8¾"

**Simon**  
PC 29-8130-22  
22 cm/8¾"

**Emmet**  
22 cm/8¾"

PC 29-8131-01

PC 29-8131-02

PC 29-8131-03

PC 29-8131-04

PC 29-8131-05

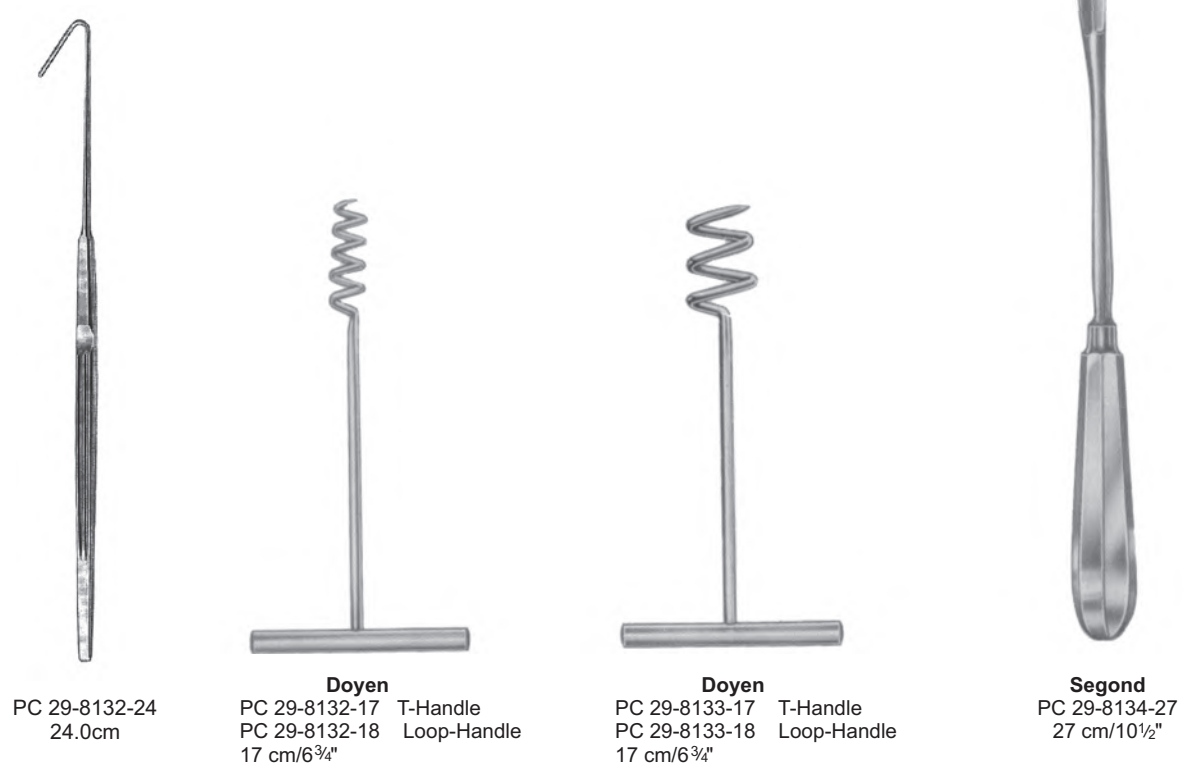

PC 29-8132-24  
24.0cm

**Doyen**  
PC 29-8132-17 T-Handle  
PC 29-8132-18 Loop-Handle  
17 cm/6¾"

**Doyen**  
PC 29-8133-17 T-Handle  
PC 29-8133-18 Loop-Handle  
17 cm/6¾"

**Segond**  
PC 29-8134-27  
27 cm/10½"

Suction Biopsy Curettes ● EN  
 Saug- und Biopsieküretten ● DE  
 Curetas aspiradoras para biopsia ● ES

Secretion Spoon



PC 29-8135-27  
27 cm/10½"



Muenchen  
27 cm/10½"



PC 29-8136-04  
4 mm



PC 29-8136-05  
5 mm



Randall  
24 cm/9½"

4 mmØ

- PC 29-8137-01 1 mm
- PC 29-8137-02 2 mm
- PC 29-8137-03 3 mm
- PC 29-8137-04 4 mm



Novak  
23 cm/9"

- PC 29-8138-01 1 mm
- PC 29-8138-02 2 mm
- PC 29-8138-03 3 mm
- PC 29-8138-04 4 mm



Novak-Schoeckaert  
PC 29-8139-24  
24 cm/9"

- EN —● Suction Biopsy Curettes
- DE —● Saug- und Biopsieküretten
- ES —● Curetas aspiradoras para biopsia





- Periosteal Raspatories ● EN
- Periosteal Raspatories ● DE
- Legras-Periostótomos ● ES



**Goodell**  
PC 29-8148-34  
34 cm/13 1/2"



**Kogan-Laser**  
24 cm

Black Insulated

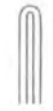

PC 29-8149-28



PC 29-8150-28



PC 29-8151-28  
28 cm/11"



**Kogan**  
PC 29-8152-24 24 cm  
PC 29-8152-48 48 cm

**Kogan**  
PC 29-8153-24 24 cm  
PC 29-8153-48 48 cm



**Kogan**  
28 cm/11"

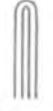

PC 29-8154-28

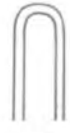

PC 29-8155-28

- EN —● Tenaculum Forceps  
 DE —● Hakenzangen  
 ES —● Pinzas para coger el cuello del útero



**Martin**  
 PC 29-8156-27  
 27 cm/10½"



**Staude-Moore**  
 PC 29-8157-17  
 17 cm/6¾"



**Barrett**  
 PC 29-8158-18  
 18 cm/7"



**Schroeder**  
 PC 29-8159-10  
 25 cm/10"



**Teale**  
 PC 29-8159-18 18.0cm  
 PC 29-8159-23 23.0cm  
 PC 29-8159-25 25.0cm



**Braun**  
 PC 29-8160-25  
 25 cm/10"



**Collin-Pozzi**  
 PC 29-8161-25  
 25 cm/10"



**Pozzi**  
 PC 29-8162-01  
 25.5 cm/10¼"



**Pozzi**  
 PC 29-8162-02  
 25.0cm



**Duplay**  
 PC 29-8163-28  
 28 cm/11"

Tenaculum Forceps ● EN  
 Hakenzangen ● DE  
 Pinzas para coger el cuello del útero ● ES

Amniotome for the  
 amnion Bladder

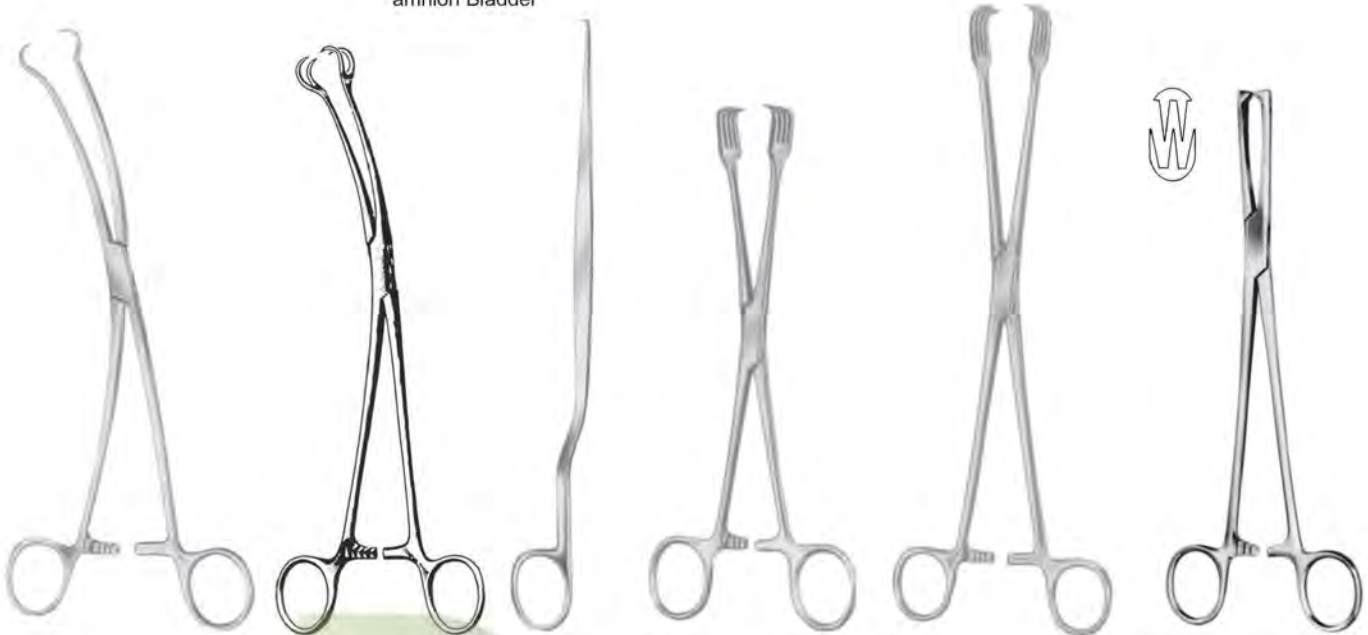

**Skene**  
 PC 29-8164-24  
 24 cm/9½"

**Skene**  
 PC 29-8164-23  
 23.0cm

**Beacham**  
 PC 29-8165-26  
 26 cm/10¼"

**Czerny**  
 PC 29-8166-20  
 20.5 cm/8¼"

PC 29-8167-26  
 26 cm/10¼"

**Henrotin**  
 PC 29-8167-20  
 20.0cm

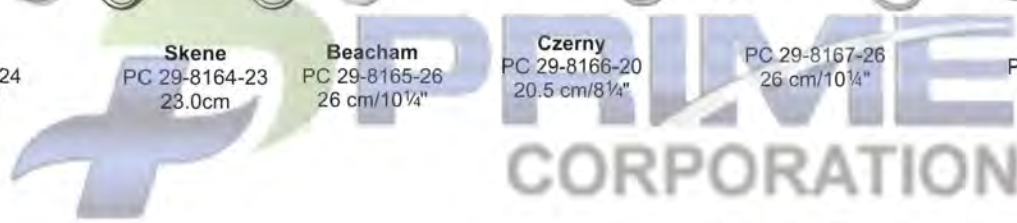

**Abel**  
 PC 29-8168-27  
 27.0cm



**Schroeder**  
 PC 29-8168-23 23 cm  
 PC 29-8168-24 24 cm  
 PC 29-8168-26 26 cm  
 Straight



**Schroeder**  
 PC 29-8169-23  
 PC 29-8169-24  
 PC 29-8169-26

Curved on Flat



**Schroeder**  
 PC 29-8170-23  
 PC 29-8170-24  
 PC 29-8170-26

Curved Sideway



**Atrauma**  
 PC 29-8171-29  
 Vulsellum Forcep  
 29cm/11 ½"



**Luer**  
 PC 29-8172-30  
 Vulsellum Forcep  
 30.5cm/12"



EN —● Tenaculum Forceps  
 DE —● Hakenzangen  
 ES —● Pinzas para coger el cuello del útero

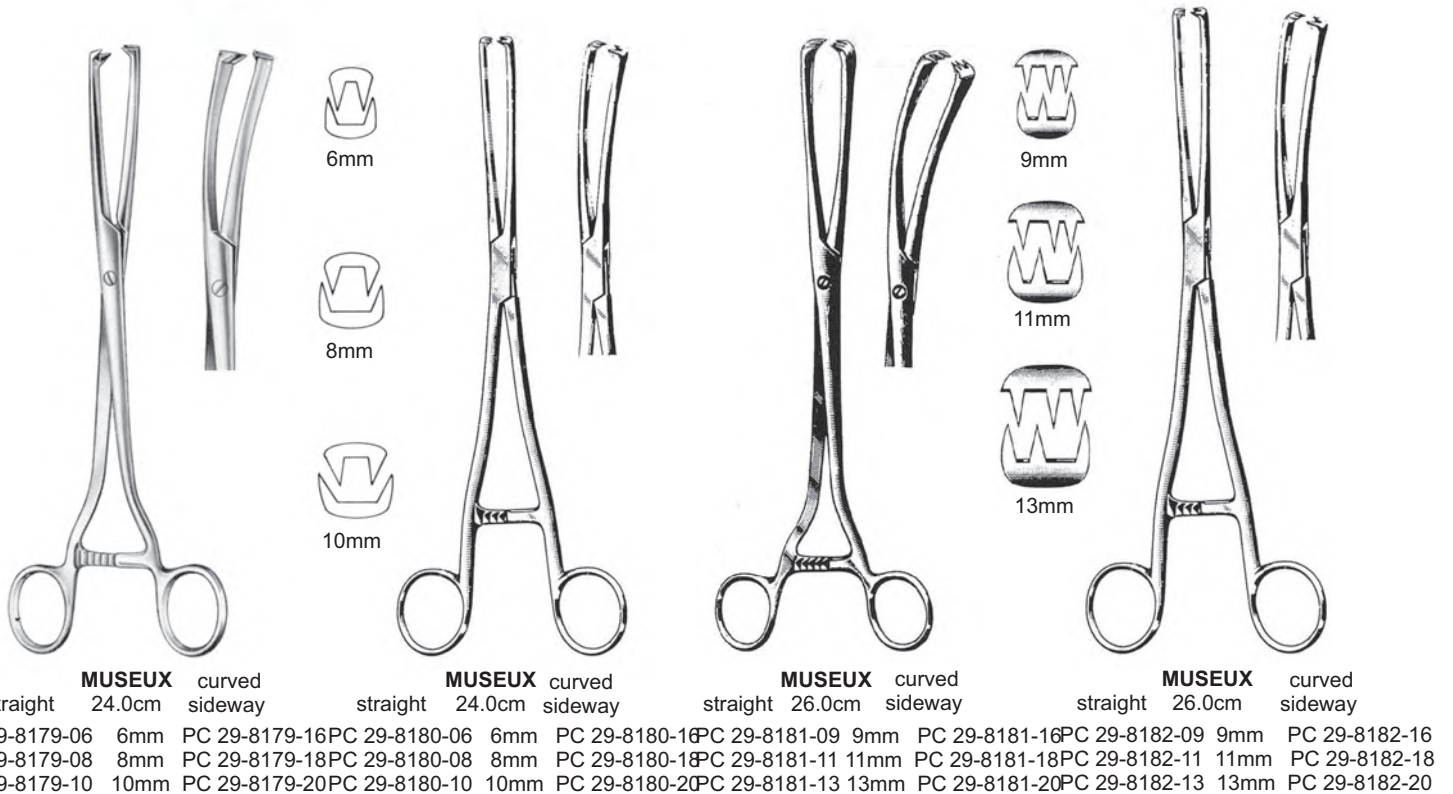

Tenaculum Forceps ● EN  
 Hakenzangen ● DE  
 Pinzas para coger el cuello del útero ● ES

For the amnion Bladder



**Pratt**  
PC 29-8183-28  
28 cm/11"



**Iowa**  
PC 29-8184-26  
26 cm/10¼"



**Jacobs**  
Straight Curved Sideway  
PC 29-8185-21 PC 29-8186-21  
21 cm/8¼"



**Bonney Polypus**  
PC 29-8187-26  
24 cm/9 ½"



**Kelly**  
PC 29-8188-32  
32 cm/12½"



**Heywood-Smith**  
PC 29-8189-20  
20 cm/8"



**Heywood-Smith**  
PC 29-8190-25  
25 cm/10"



**Noto**  
PC 29-8191-27  
27 cm/10½"

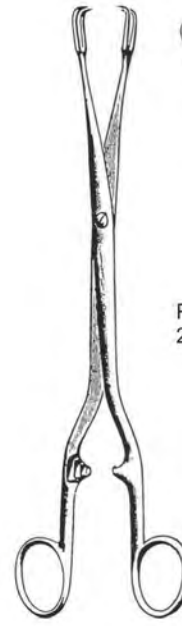

**Schroeder**  
PC 29-8192-01  
26.0cm

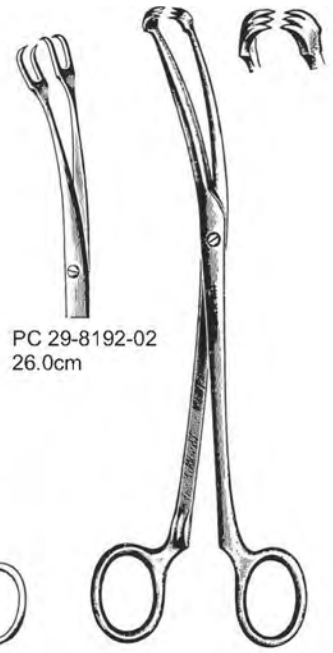

**Teale**  
PC 29-8193-18 18.0cm  
PC 29-8193-23 23.0cm



- EN —• Uterine Elevating, Ovarian Forceps, Vaginal Clamps
- DE —• Uterine Erhebend, Ovarian Pinzetten, Vaginal Schellen
- ES —• Elevación uterino, de ovario fórceps

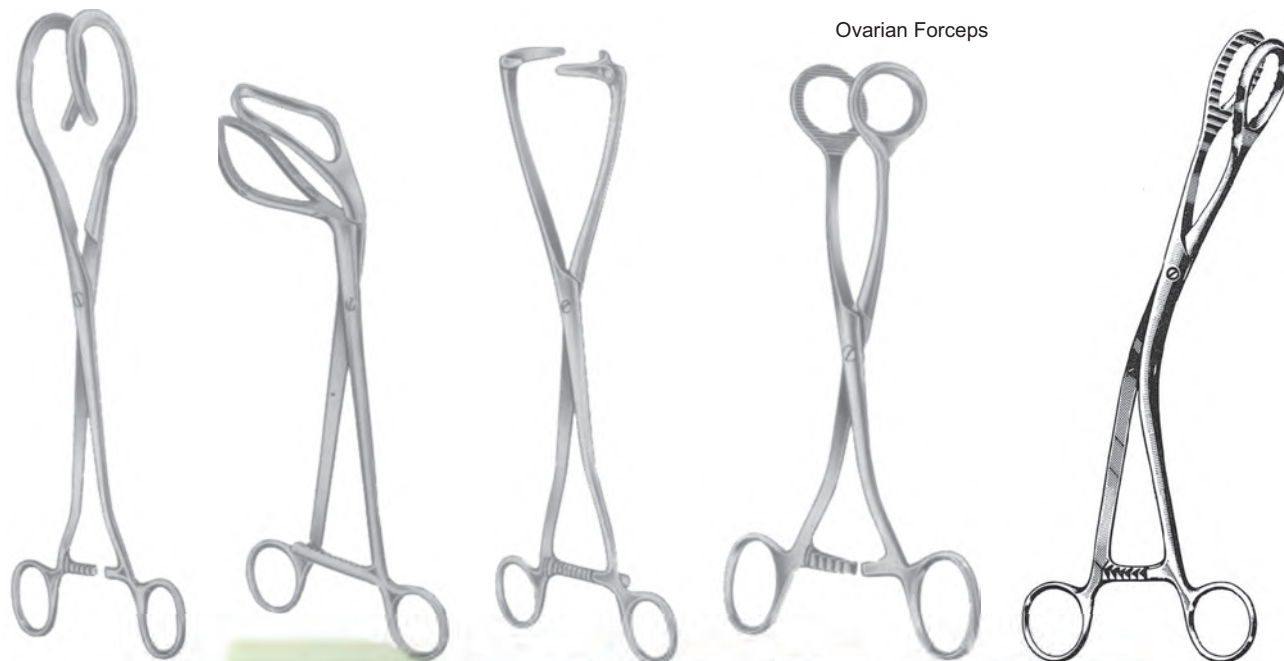

Ovarian Forceps

**Dartigues**  
PC 29-8194-27  
27 cm/10½"

**Somer**  
PC 29-8195-23  
23 cm/9"

**Collin**  
PC 29-8196-25  
25 cm/10"

**Doyen**  
PC 29-8197-18 18 cm/7"  
PC 29-8197-20 20 cm/8"

**Pruesmann**  
PC 29-8197-27  
27.5cm



**Bonney**  
PC 29-8198-27  
27 cm/11"

**Bonney**  
PC 29-8199-27  
27 cm/10½"

**Bonney**  
PC 29-8200-20  
20 cm/8"  
curved

**Bonney Berkley**  
PC 29-8201-20  
20 cm/8"  
angled

Cervical Biopsy and Specimen Forceps ● EN  
 Probeexzisionszangen ● DE  
 Pinzas saca-bocados para biosia ● ES



**THOMS-GAYLOR**  
PC 29-8202-24  
24.0cm



**THOMS-GAYLOR**  
PC 29-8203-24 24.0cm



PC 29-8204-01



PC 29-8204-02

**VAN DOREN**  
24.0cm



**GELLHORN**  
PC 29-8205-23  
23.0cm



**FAURE**  
PC 29-8206-21  
21.0cm



**SCHUBERT**  
PC 29-8207-26  
26.0cm



**SCHUBERT**  
PC 29-8208-21 21.0cm  
PC 29-8208-29 29.0cm

- EN —● Cervical Biopsy and Specimen Forceps
- DE —● Probeexzisionszangen
- ES —● Pinzas saca-bocados para biopsia

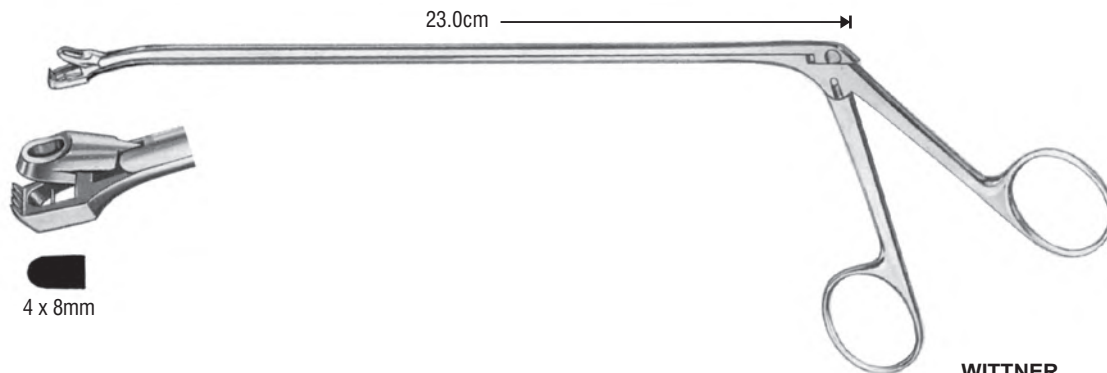

**WITTNER**

PC 29-8209-23 23.0cm (straight)  
PC 29-8210-23 23.0cm (angled)

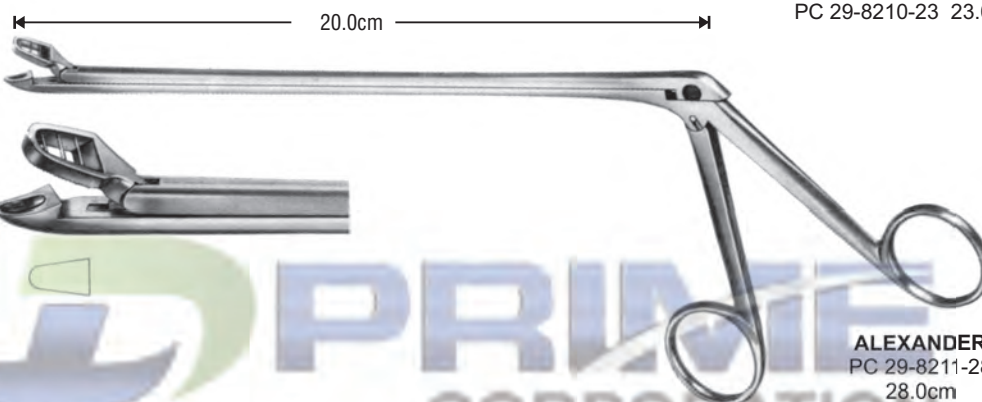

**ALEXANDER**  
PC 29-8211-28  
28.0cm

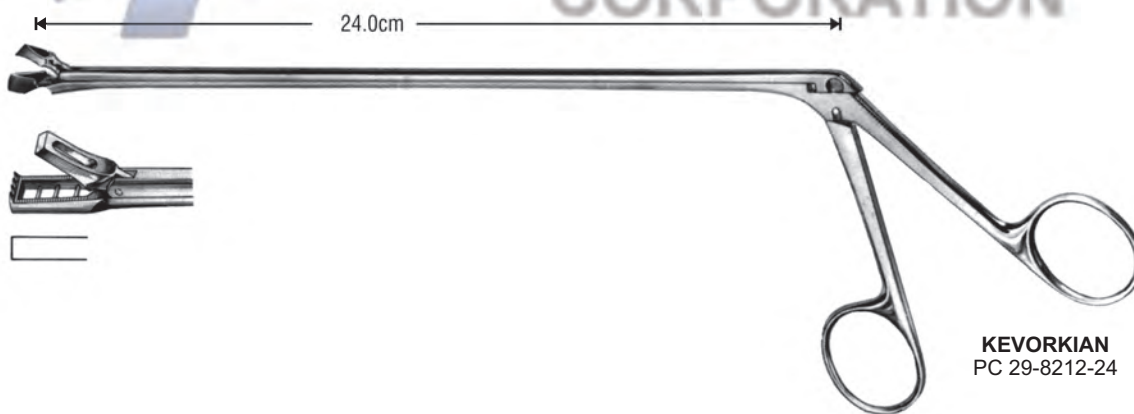

**KEVORKIAN**  
PC 29-8212-24

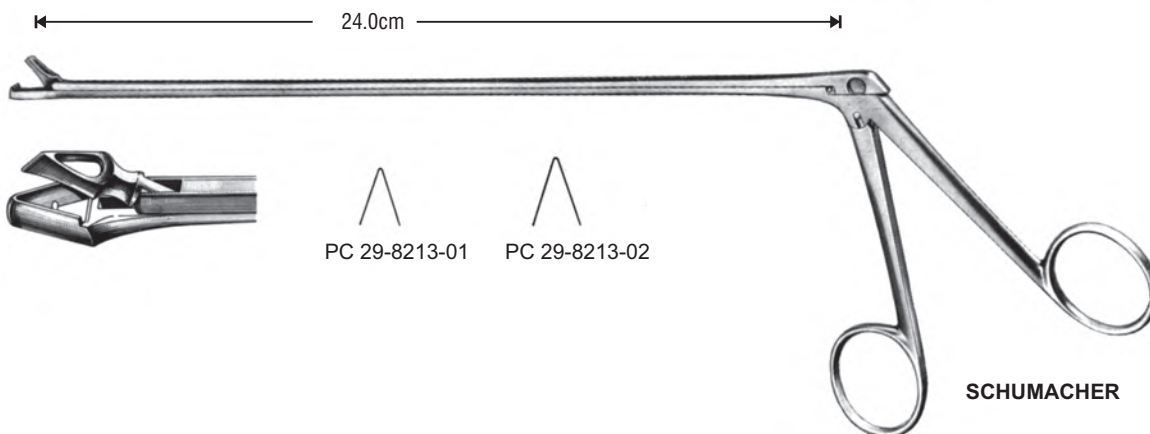

**SCHUMACHER**

PC 29-8213-01

PC 29-8213-02



Cervical Biopsy and Specimen Forceps ● EN  
 Probeexzisionszangen ● DE  
 Pinzas saca-bocados para biopsia ● ES



■ 2.3 x 4.2 mm



**TOWNSEND-MINI**  
PC 29-8214-00



■ 3 x 9.5 mm



**TISCHLER-KEVORKIAN**  
PC 29-8215-00



● 4 x 6.5 mm



**BAGGISH**  
PC 29-8216-00



■ 4 x 8 mm

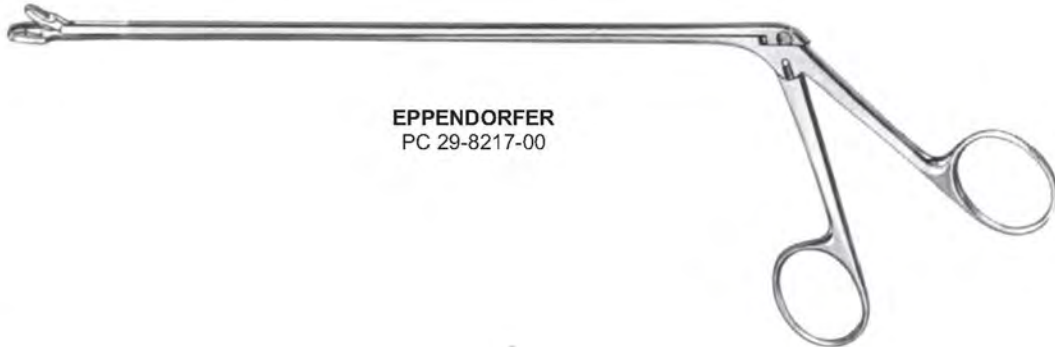

**EPPENDORFER**  
PC 29-8217-00

- EN —● Cervical Biopsy and Specimen Forceps
- DE —● Probeexzisionszangen
- ES —● Pinzas saca-hocados para hionsía



oval  
7 x 5 mm

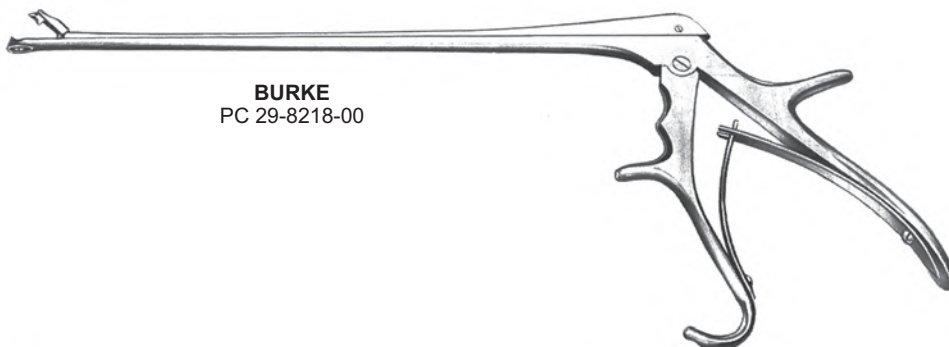

**BURKE**  
PC 29-8218-00



3 x 8 mm

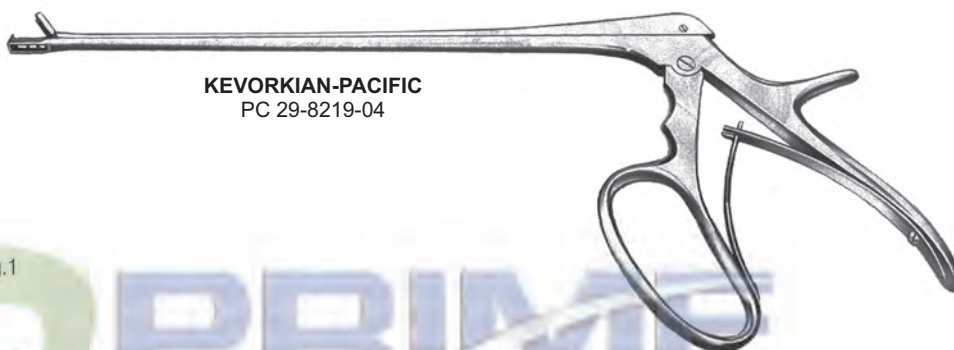

**KEVORKIAN-PACIFIC**  
PC 29-8219-04



Fig.1

**TISCHLER-MORGAN**



Fig.3

oval ● 3.7 x 5 mm



Fig.4

**KEVORKIAN**



Fig.5

mini

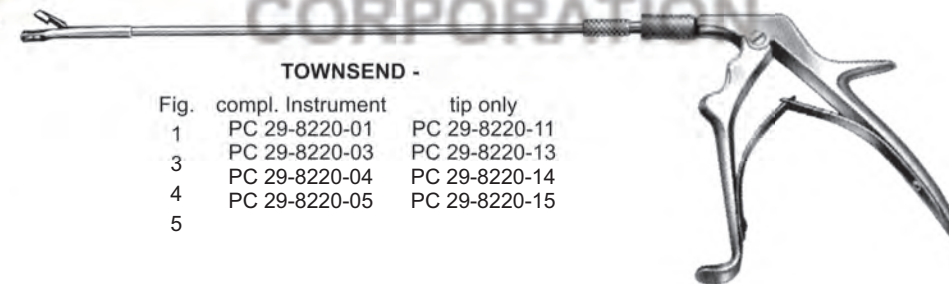

**TOWNSEND -**

Fig.	compl. Instrument	tip only
1	PC 29-8220-01	PC 29-8220-11
	PC 29-8220-03	PC 29-8220-13
3	PC 29-8220-04	PC 29-8220-14
4	PC 29-8220-05	PC 29-8220-15
5		

PC 29-8220-99  
handle only



Tip only



**SCHUMACHER**  
PC 29-8221-00



PC 29-8221-01



Uterine Scoops ●— EN  
 Uterusloffel ●— DE  
 Cucharillas uterinas ●— ES

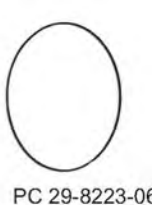
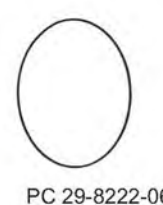
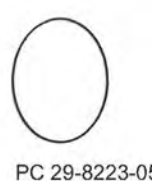
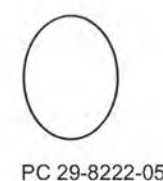
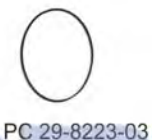
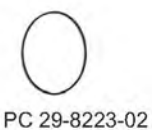
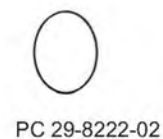
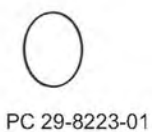
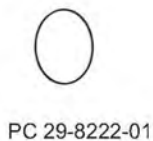

**SIMON**  
25.0cm, sharp, rigid



**SCHROEDER**  
30.0cm, sharp, rigid



**GOURDET**  
28.0cm, blunt

EN —● Uterine Curettes  
 DE —● Uterusküretten  
 ES —● Curetas uterinas

**SIMS**  
31.0cm

**RECAMIER**  
31.0cm

Fig	sharp	blunt	sharp	blunt
00	PC 29-8229-05	PC 29-8230-05	PC 29-8227-05	PC 29-8228-05
0	PC 29-8229-06	PC 29-8230-06	PC 29-8227-06	PC 29-8228-06
1	PC 29-8229-07	PC 29-8230-07	PC 29-8227-07	PC 29-8228-07
2	PC 29-8229-08	PC 29-8230-08	PC 29-8227-08	PC 29-8228-08
3	PC 29-8229-09	PC 29-8230-09	PC 29-8227-09	PC 29-8228-09
4	PC 29-8229-10	PC 29-8230-10	PC 29-8227-10	PC 29-8228-10
5	PC 29-8229-11	PC 29-8230-11	PC 29-8227-11	PC 29-8228-11
6	PC 29-8229-12	PC 29-8230-12	PC 29-8227-12	PC 29-8228-12
7	PC 29-8229-13	PC 29-8230-13	PC 29-8227-13	PC 29-8228-13
8	PC 29-8229-14	PC 29-8230-14	PC 29-8227-14	PC 29-8228-14
9	PC 29-8229-15	PC 29-8230-15	PC 29-8227-15	PC 29-8228-15
10	PC 29-8229-16	PC 29-8230-16	PC 29-8227-16	PC 29-8228-16
11	PC 29-8229-17	PC 29-8230-17	PC 29-8227-17	PC 29-8228-17
12	PC 29-8229-18	PC 29-8230-18	PC 29-8227-18	PC 29-8228-18
13	PC 29-8229-19	PC 29-8230-19	PC 29-8227-19	PC 29-8228-19
14	PC 29-8229-20	PC 29-8230-20	PC 29-8227-20	PC 29-8228-20
15	PC 29-8229-21	PC 29-8230-21	PC 29-8227-21	PC 29-8228-21
16	PC 29-8229-22	PC 29-8230-22	PC 29-8227-22	PC 29-8228-22
	PC 29-8225-05	PC 29-8226-05	PC 29-8225-06	PC 29-8226-06
	PC 29-8225-06	PC 29-8226-06	PC 29-8225-07	PC 29-8226-07
	PC 29-8225-07	PC 29-8226-07	PC 29-8225-08	PC 29-8226-08
	PC 29-8225-08	PC 29-8226-08	PC 29-8225-09	PC 29-8226-09
	PC 29-8225-09	PC 29-8226-09	PC 29-8225-10	PC 29-8226-10
	PC 29-8225-10	PC 29-8226-10	PC 29-8225-11	PC 29-8226-11
	PC 29-8225-11	PC 29-8226-11	PC 29-8225-12	PC 29-8226-12
	PC 29-8225-12	PC 29-8226-12	PC 29-8225-13	PC 29-8226-13
	PC 29-8225-13	PC 29-8226-13	PC 29-8225-14	PC 29-8226-14
	PC 29-8225-14	PC 29-8226-14	PC 29-8225-15	PC 29-8226-15
	PC 29-8225-15	PC 29-8226-15	PC 29-8225-16	PC 29-8226-16
	PC 29-8225-16	PC 29-8226-16	PC 29-8225-17	PC 29-8226-17
	PC 29-8225-17	PC 29-8226-17	PC 29-8225-18	PC 29-8226-18
	PC 29-8225-18	PC 29-8226-18	PC 29-8225-19	PC 29-8226-19
	PC 29-8225-19	PC 29-8226-19	PC 29-8225-20	PC 29-8226-20
	PC 29-8225-20	PC 29-8226-20	PC 29-8225-21	PC 29-8226-21
	PC 29-8225-21	PC 29-8226-21	PC 29-8225-22	PC 29-8226-22
	PC 29-8225-22	PC 29-8226-22	PC 29-8225-23	PC 29-8226-23
	PC 29-8225-23	PC 29-8226-23	PC 29-8225-24	PC 29-8226-24
	PC 29-8225-24	PC 29-8226-24	PC 29-8225-25	PC 29-8226-25
	PC 29-8225-25	PC 29-8226-25	PC 29-8225-26	PC 29-8226-26
	PC 29-8225-26	PC 29-8226-26	PC 29-8225-27	PC 29-8226-27
	PC 29-8225-27	PC 29-8226-27	PC 29-8225-28	PC 29-8226-28
	PC 29-8225-28	PC 29-8226-28	PC 29-8225-29	PC 29-8226-29
	PC 29-8225-29	PC 29-8226-29	PC 29-8225-30	PC 29-8226-30
	PC 29-8225-30	PC 29-8226-30	PC 29-8225-31	PC 29-8226-31
	PC 29-8225-31	PC 29-8226-31	PC 29-8225-32	PC 29-8226-32
	PC 29-8225-32	PC 29-8226-32	PC 29-8225-33	PC 29-8226-33
	PC 29-8225-33	PC 29-8226-33	PC 29-8225-34	PC 29-8226-34
	PC 29-8225-34	PC 29-8226-34	PC 29-8225-35	PC 29-8226-35
	PC 29-8225-35	PC 29-8226-35	PC 29-8225-36	PC 29-8226-36
	PC 29-8225-36	PC 29-8226-36	PC 29-8225-37	PC 29-8226-37
	PC 29-8225-37	PC 29-8226-37	PC 29-8225-38	PC 29-8226-38
	PC 29-8225-38	PC 29-8226-38	PC 29-8225-39	PC 29-8226-39
	PC 29-8225-39	PC 29-8226-39	PC 29-8225-40	PC 29-8226-40

Uterine Scoops — EN  
Uterusloffel — DE  
Cucharillas uterinas — ES

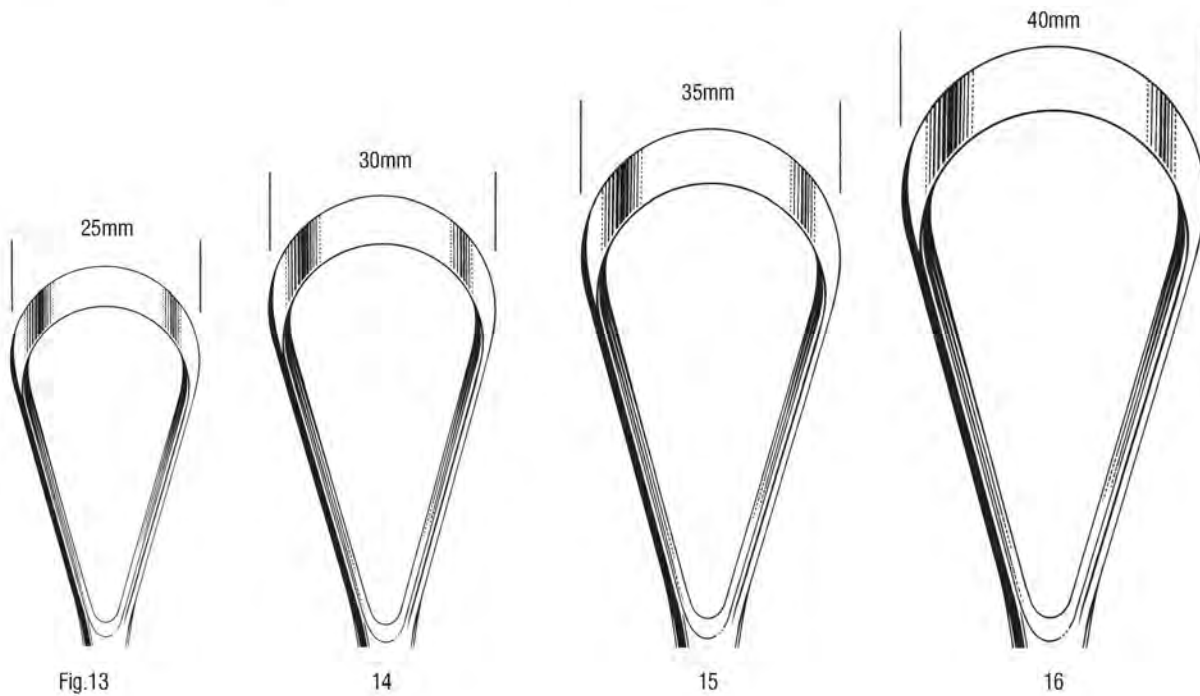
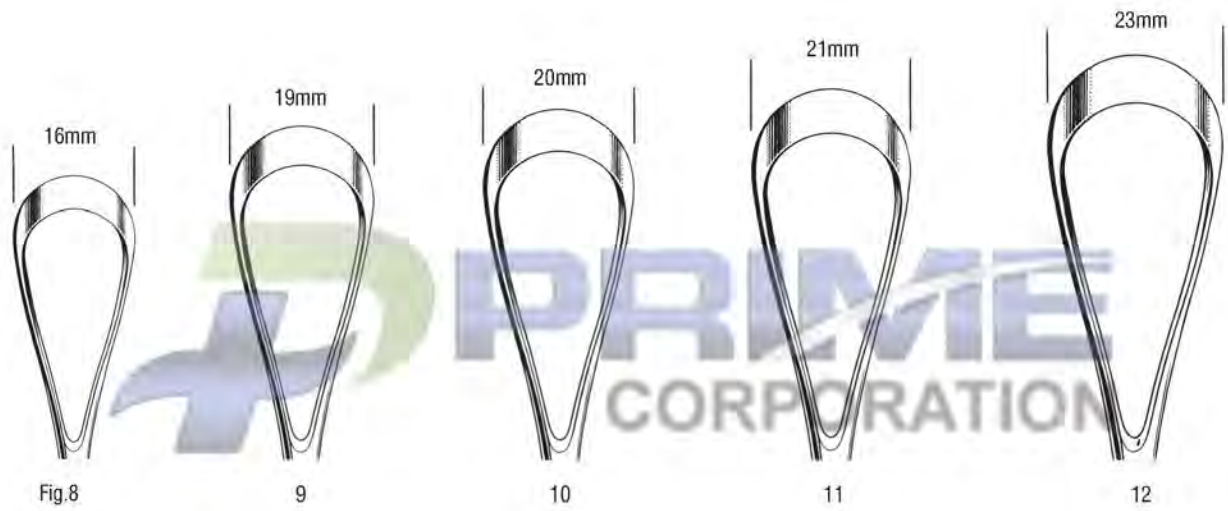
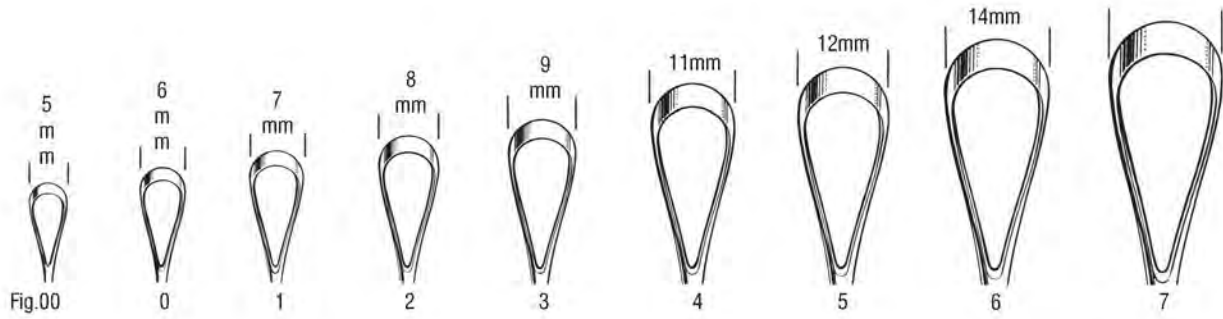

- EN —● Uterine Curettes
- DE —● Uterusküretten
- ES —● Curetas uterinas



Fig	sharp	blunt	sharp	blunt
13	PC 29-8233-25	PC 29-8234-25	PC 29-8235-25	PC 29-8236-25
14	PC 29-8233-30	PC 29-8234-30	PC 29-8235-30	PC 29-8236-30
15	PC 29-8233-35	PC 29-8234-35	PC 29-8235-35	PC 29-8236-35
16	PC 29-8233-40	PC 29-8234-40	PC 29-8235-40	PC 29-8236-40



Uterine Scoops ●— EN  
 Uterusloffel ●— DE  
 Cucharillas uterinas ●— ES



28.0cm

Fig.		mm
1	PC 29-8237-01	4.5
2	PC 29-8237-02	6
3	PC 29-8237-03	9
4	PC 29-8237-04	12
5	PC 29-8237-05	15

**OLSHAUSEN'S**  
27.0cm

Fig.	
1	PC 29-8238-01
2	PC 29-8238-02
3	PC 29-8238-03
4	PC 29-8238-04
5	PC 29-8238-05

**BUMM'S**  
28.0cm

Fig.	
1	PC 29-8239-01
2	PC 29-8239-02
3	PC 29-8239-03
4	PC 29-8239-04
5	PC 29-8239-05



EN —● Uterine Curettes  
 DE —● Uterusküretten  
 ES —● Curetas uterinas



**SIMS**  
 25.0cm

sharp	Fig	blunt
PC 29-8240-01	1	PC 29-8241-01
PC 29-8240-02	2	PC 29-8241-02
PC 29-8240-03	3	PC 29-8241-03
PC 29-8240-04	4	PC 29-8241-04
PC 29-8240-05	5	PC 29-8241-05
PC 29-8240-06	6	PC 29-8241-06

**SIMS**  
 25.0cm

sharp	Fig	blunt
PC 29-8242-01	1	PC 29-8243-01
PC 29-8242-02	2	PC 29-8243-02
PC 29-8242-03	3	PC 29-8243-03

sharp / blunt  
 PC 29-8244-27 27.0cm

**BLAKE**  
 sharp / blunt  
 PC 29-8245-27 27.0cm



**SIMS**  
 PC 29-8246-25  
 25.0cm, sharp

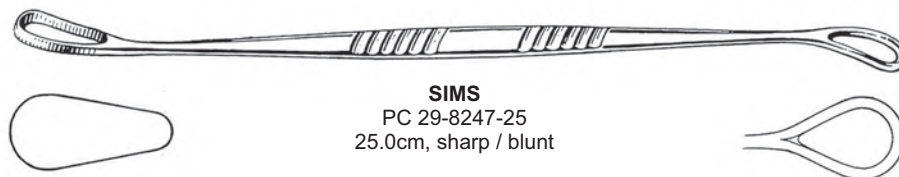

**SIMS**  
 PC 29-8247-25  
 25.0cm, sharp / blunt

Uterine Scoops ● EN  
 Uterusloffel ● DE  
 Cucharillas uterinas ● ES



Fig.1

**UNIVERSAL**  
28.0cm

- Fig  
 1 PC 29-8248-01  
 2 PC 29-8248-02  
 3 PC 29-8248-03

**RHEINSTADTER**  
29.0cm

- |                       |               |
|-----------------------|---------------|
| sharp                 | blunt         |
| PC 29-8249-01 7.9 mm  | PC 29-8250-01 |
| PC 29-8249-02 11.1 mm | PC 29-8250-02 |
| PC 29-8249-03 14.3mm  | PC 29-8250-03 |

**CHELSEA HOSPITAL**  
PC 29-8251-31 31.0cm

**DONALD**  
sharp  
PC 29-8252-33 33.0cm

- EN —● Suction Biopsy Curettes
- DE —● Saug und Biopsiekuretten
- ES —● Curetas aspiradores para biopsia

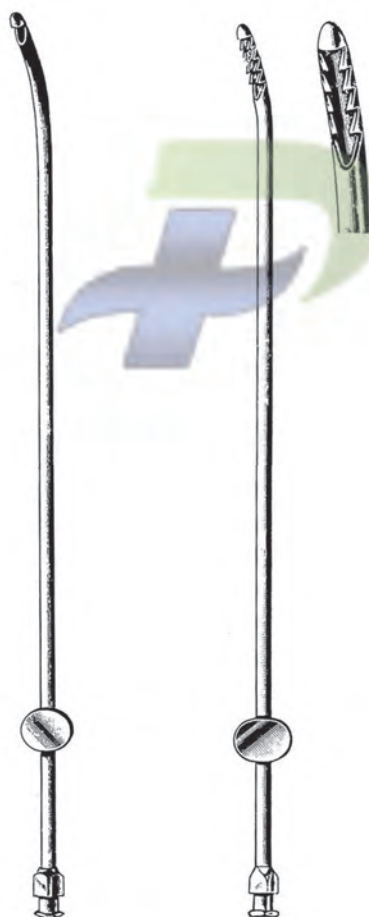

**RANDALL**  
24.0cm  
1mm dia. PC 29-8253-01  
2mm dia. PC 29-8253-02  
3mm dia. PC 29-8253-03  
4mm dia. PC 29-8253-04

**NOVAK**  
23.0cm  
PC 29-8254-01  
PC 29-8254-02  
PC 29-8254-03  
PC 29-8254-04



**SHERMAN**  
PC 29-8255-23 23.0cm  
3.5mm dia.

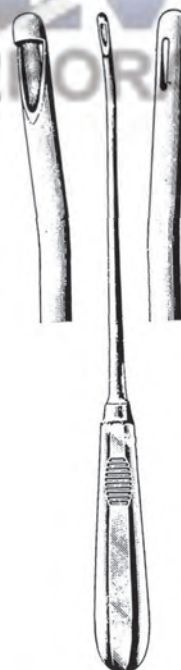

**MUENCHEN**  
PC 29-8256-27 27.0cm

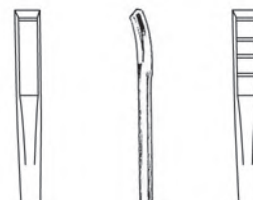

with basket



**KEVORKIAN**  
30.0cm  
PC 29-8257-12 1.2mm PC 29-8258-12  
PC 29-8257-40 4.0mm PC 29-8258-40

- EN** Obstetrics
- DE** Geburtshilfe
- ES** Obstetricia

Page 723 to 740

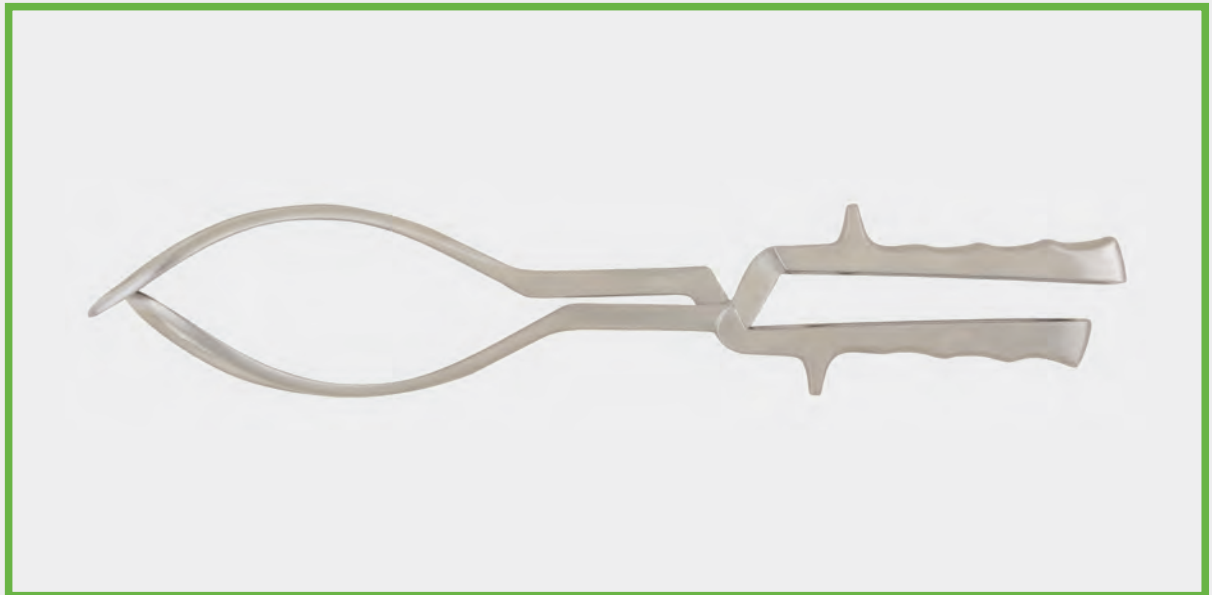

- EN —●— Obstetrical Forceps
- DE —●— Geburtszangen
- ES —●— Forceps obstetricos



**WRIGLEY**  
PC 30-8401-23 23.0cm  
PC 30-8401-28 28.0cm



**DE-LEE**  
PC 30-8402-30  
30.0cm



**DE-LEE**  
PC 30-8403-36  
36.0cm



**SIMPSON**  
PC 30-8404-23 23.0cm, str.  
PC 30-8405-23 23.0cm, cvd.



**SIMPSON**  
PC 30-8406-23 23.0cm  
PC 30-8406-30 30.0cm

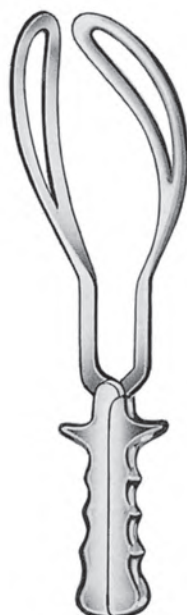

**SIMPSON-BRAUN**  
PC 30-8407-33 33.0cm  
PC 30-8407-36 36.0cm



**KIELLAND**  
PC 30-8408-41  
41.0cm



**PIPER**  
PC 30-8409-44  
44.0cm



Obstetrical Forceps ●— EN  
 Geburtszangen ●— DE  
 Forceps obstetricos ●— ES

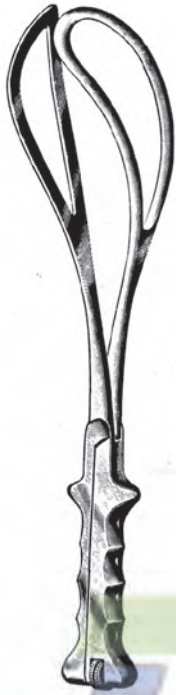

**ELLIOT**  
 PC 30-8410-32 32.0cm  
 PC 30-8410-38 38.0cm



**NAEGELE**  
 PC 30-8411-36 36.0cm  
 PC 30-8411-40 40.0cm



**KEDAR NATH DAS**  
 PC 30-8412-33 33.0cm



**BOERMA**  
 PC 30-8413-29 29.0cm

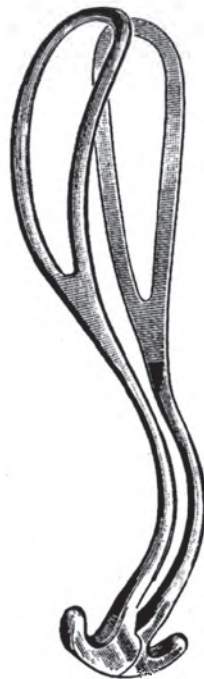

**LAUFE-PIPER**  
 PC 30-8414-30 30.0cm

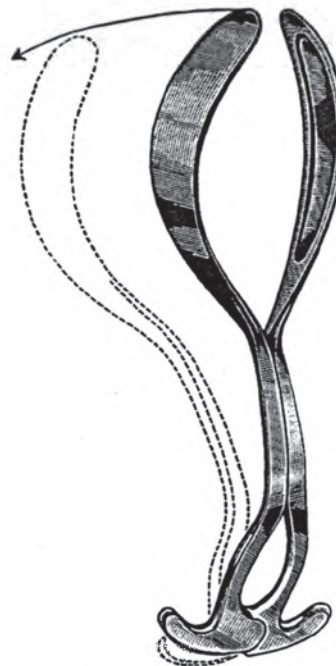

**LAUFE DIVERGENT OUTLET**  
 PC 30-8415-31 31.0cm

- EN —●— Obstetrical Forceps  
 DE —●— Geburtszangen  
 ES —●— Forceps obstetricos

**SIMPSON-LUIKART**  
 PC 30-8416-36  
 36.0cm



**McLEAN**  
 PC 30-8419-36  
 36.0cm

**KIELLAND-LUIKART**  
 PC 30-8417-40  
 40.0cm



**McLEAN-TUCKER**  
 PC 30-8420-39  
 39.0cm

**LUIKART**  
 PC 30-8418-40  
 40.0cm



**McLEAN-TUCKER-LUIKART**  
 PC 30-8421-40  
 40.0cm

Obstetrical Forceps — EN  
 Geburtszangen — DE  
 Forceps obstetricos — ES



**HIRST**  
PC 30-8422-26  
26.0cm



**ANDERSON**  
PC 30-8423-38  
38.0cm



**BARTON**  
PC 30-8424-36  
36.0cm

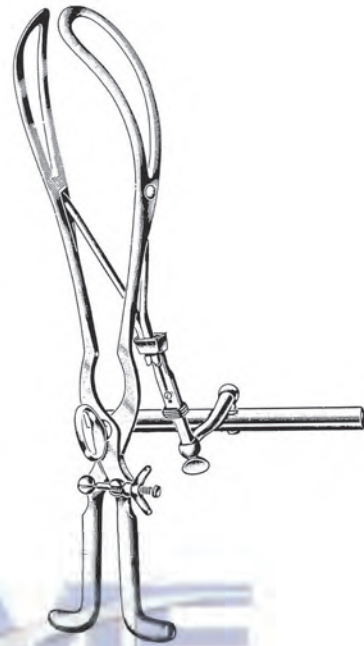

**TARNIER**  
PC 30-8425-40  
40.0cm



**KEDAR NATH DAS**  
PC 30-8426-38  
38.0cm



**DEWEY**  
PC 30-8427-37  
37.0cm



**BARNES-NEVILLE-SIMPSON**  
PC 30-8428-40  
40.0cm

- EN —●— Obstetrical Forceps
- DE —●— Geburtszangen
- ES —●— Forceps obstetricos



**MILNE-MURRAY**  
PC 30-8429-40  
40.0cm

**BARNES-NEVILLE**  
PC 30-8430-40  
40.0cm

**HAIG-FERGUSON**  
PC 30-8431-40  
40.0cm

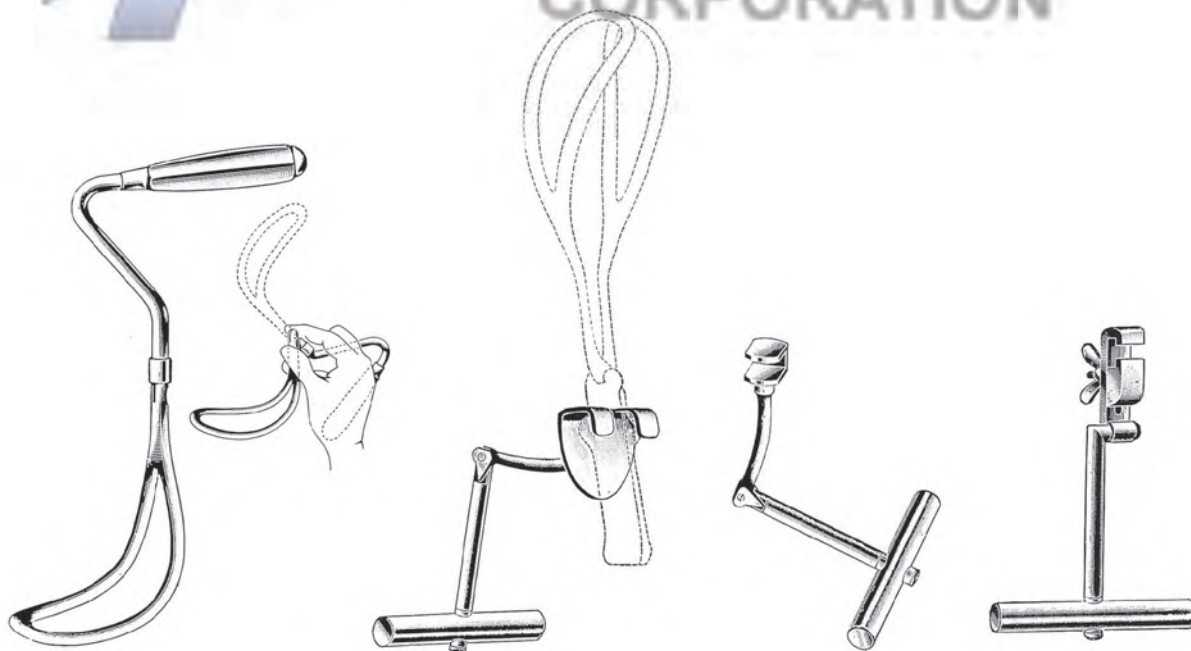

**MURLESS**  
PC 30-8432-26  
26.0cm

**BILL**  
PC 30-8433-21  
21.0cm

**LUIKART-BILL**  
PC 30-8434-21  
21.0cm

**BARTON**  
PC 30-8435-17  
17.0cm



Perforator, Cranioclast ●— EN  
 Parforatorien-Kranioklast ●— DE  
 Perforador, craneoclasto ●— ES



**SMELLIE**  
PC 30-8436-25  
25.0cm



**NAEGELE**  
PC 30-8437-25  
25.0cm



**WINTER**  
PC 30-8438-36  
36.0cm

**AUVARD-ZWEIFEL**  
PC 30-8439-42  
42.0cm

**TARNIER**  
PC 30-8440-46  
46.0cm

**BRAUN**  
PC 30-8441-42  
42.0cm



- EN —● Uterine Haemostasis Forceps and Umbilical Cord Clamps
- DE —● Uterus-Klemmzange und Nabelschnurklemmen
- ES —● Pinzas uterinas p/hemostasis y clamps umbilicales

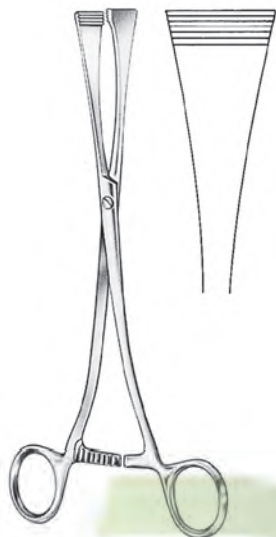

**GREEN-ARMYTAGE**  
PC 30-8442-21  
21.0cm

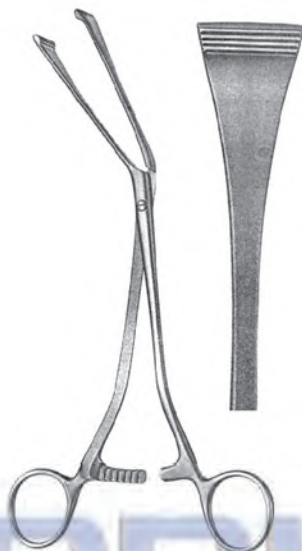

**GREEN-ARMYTAGE**  
PC 30-8443-19  
19.5cm

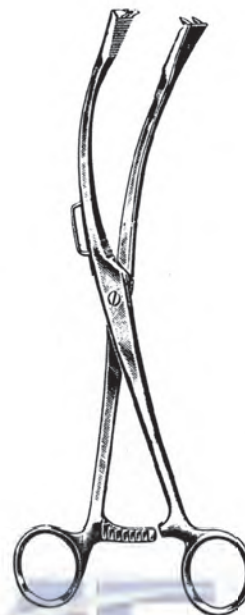

**GAUSS**  
PC 30-8444-26  
26.0cm

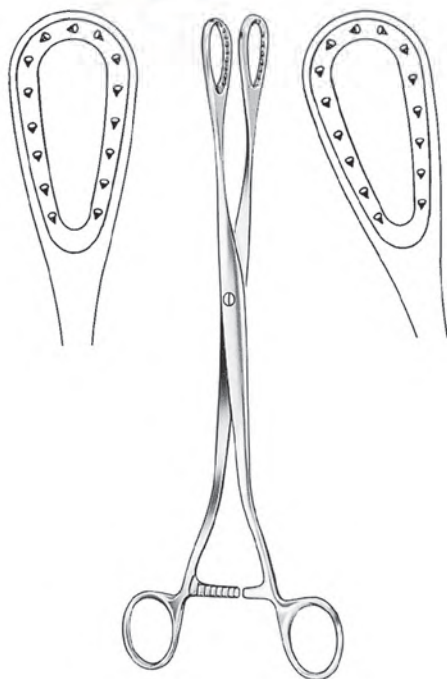

**SAENGER**  
PC 30-8445-27 27.0cm PC 30-8446-27



**SELLHEIM**  
PC 30-8447-28  
28.0cm



**KANE**  
PC 30-8448-08  
8.5cm



**COLLIN**  
PC 30-8449-09  
9.0cm

Placenta and Ovum forceps ●— EN  
 Plazenter-und-Abortuszangen ●— DE  
 Pinzas para abortoto y placenta ●— ES



**HEYWOOD-SMITH**  
PC 30-8450-25  
25.0cm



**COREY**  
PC 30-8451-24  
24.0cm

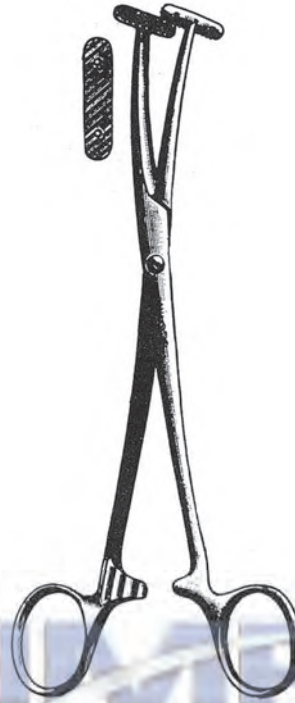

**WILLET**  
PC 30-8452-19  
19.0cm

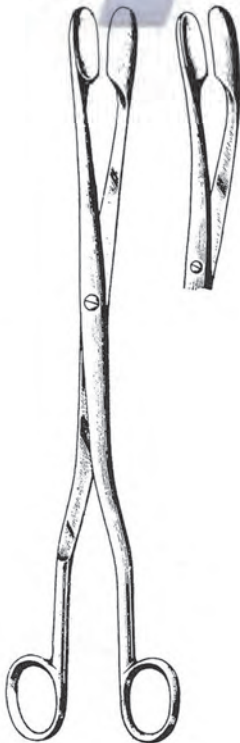

**WINTER**  
28.0cm

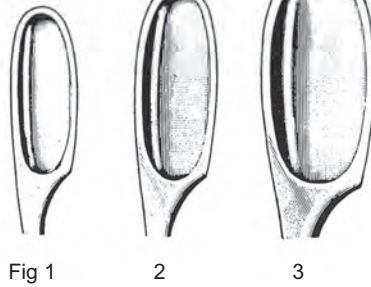
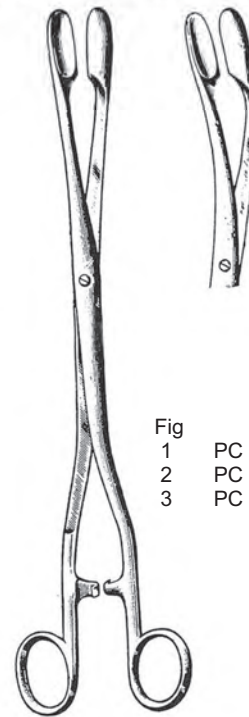

Fig	str	cur
1	PC 30-8453-01	PC 30-8454-01
2	PC 30-8453-02	PC 30-8454-02
3	PC 30-8453-03	PC 30-8454-03



**WINTER-NASSAUER**  
28.0cm

Fig	str	cur
1	PC 30-8455-01	PC 30-8456-01
2	PC 30-8455-02	PC 30-8456-02
3	PC 30-8455-03	PC 30-8456-03

- EN —● Placenta and Ovum Forceps  
 DE —● Plazenter-und-Abortuszgen  
 ES —● pinzas para aborto v placenta



**Mc CLINTOCK**  
 PC 30-8457-24  
 24.0cm

**BONNEY**  
 PC 30-8458-24  
 24.0cm

**VANT'S**  
 PC 30-8459-24 24.0cm  
 PC 30-8459-27 27.0cm

**BIERER**  
 PC 30-8460-28  
 28.0cm

- Placenta Forceps ●— EN
- Plazenterzangen ●— DE
- Pinzas para placenta ●— ES

Cordura Jackets

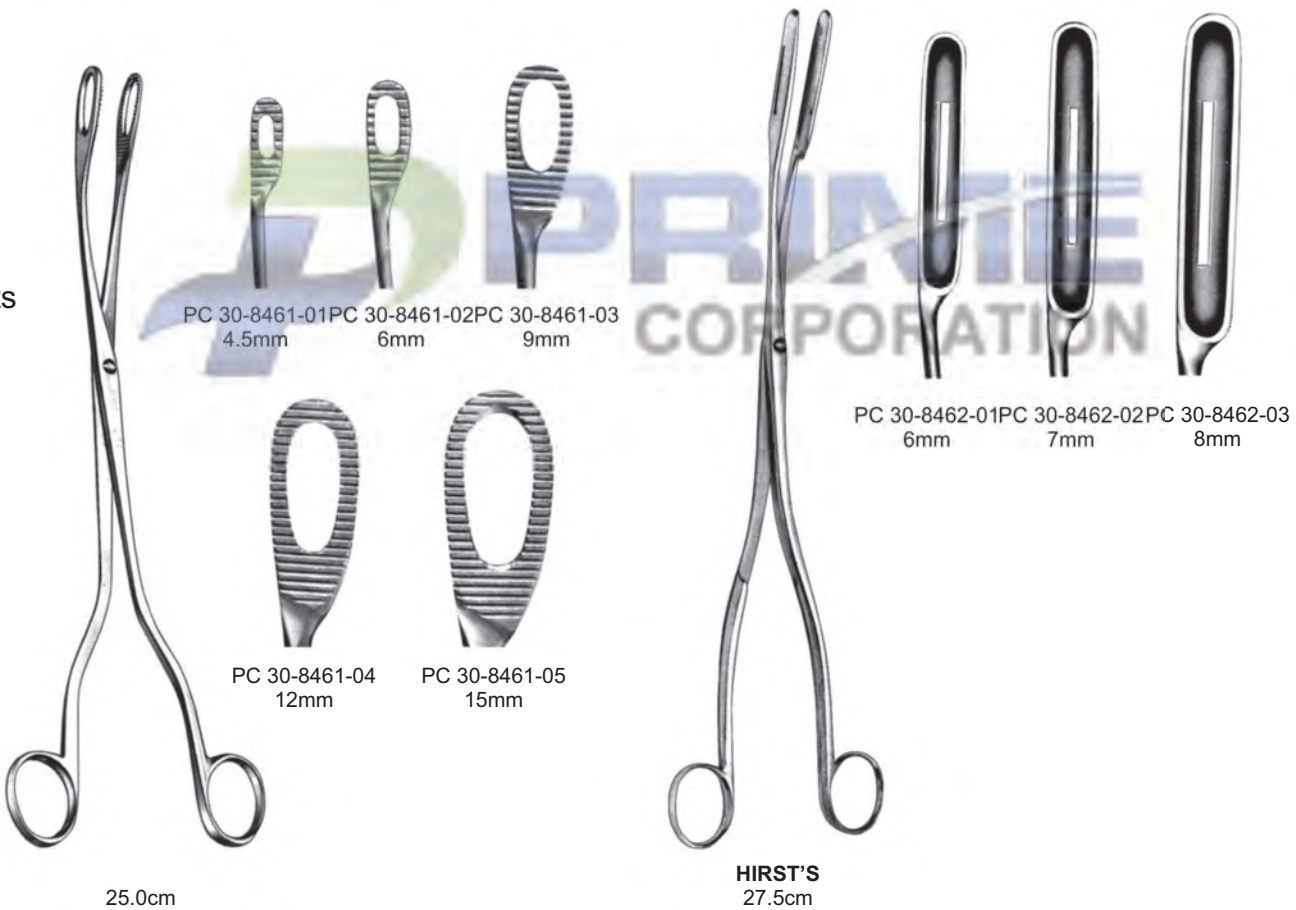



- EN —• Uterine Elevator  
 DE —• Uterus Elevatorien  
 ES —• Elevadores uterinos

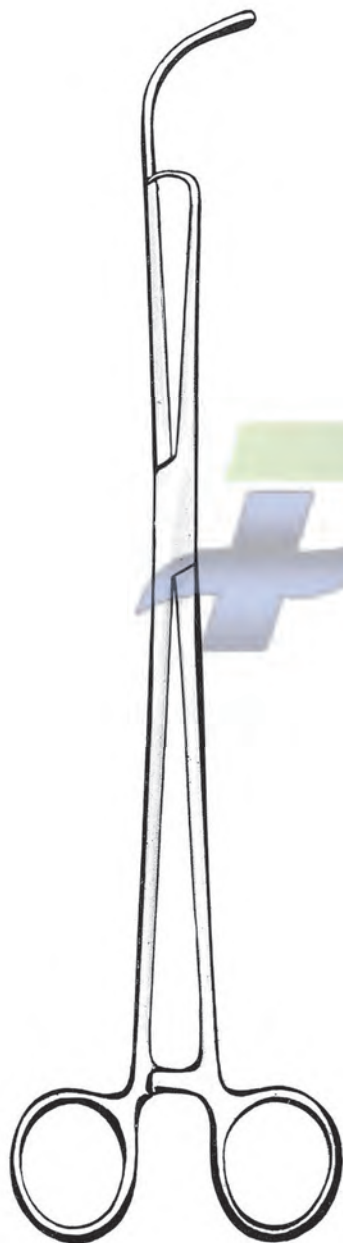

**HULKA**  
 PC 30-8463-30  
 30.0cm



**HULKA**  
 PC 30-8464-30  
 30.0cm

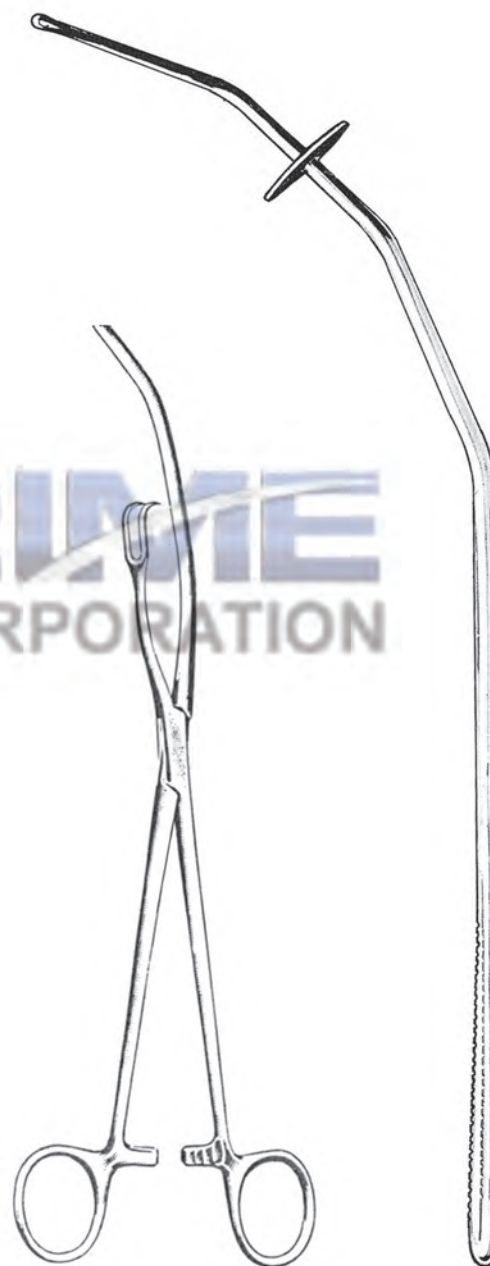

**HULKA-KENWICK**  
 PC 30-8465-27  
 27.5cm

**RAMATHIBODI**  
 PC 30-8466-00



Catheters ●— EN  
 Katheter ●— DE  
 Traqueal ●— ES



**CARTON**  
 PC 30-8467-30  
 30.0cm  
 5mm Ø



**MARSHAL-COWELL**  
 PC 30-8468-00



**BOZEMANN-FRITSCH**  
 PC 30-8469-08 8mm Ø  
 PC 30-8469-10 10mm Ø  
 PC 30-8469-12 12mm Ø



**DREW-SMYTHE**  
 PC 30-8470-33  
 33.5cm

- EN —● Intra-Uterine Cannula
- DE —● Intrauterine Kanülen
- ES —● Canulas intrauterino



**SPACKMANN**  
PC 30-8471-35  
35.0cm



**SPACKMANN**  
PC 30-8472-35  
35.0cm



**LEECH-WILKINSON**  
26.5cm



PC 30-8473-01  
Ø 10 x 25mm  
small



PC 30-8473-02  
Ø 13 x 30mm  
medium



PC 30-8473-03  
Ø 16 x 30mm  
large

Ovum Curettes, Abortion Scoops ●— EN  
 Abortuskuretten und loffel ●— DE  
 Curetas y cucharillas para aborto ●— ES



- EN — Aspirating Curettes
- DE — Absaygkuretten
- ES — Curetas de aspiracion

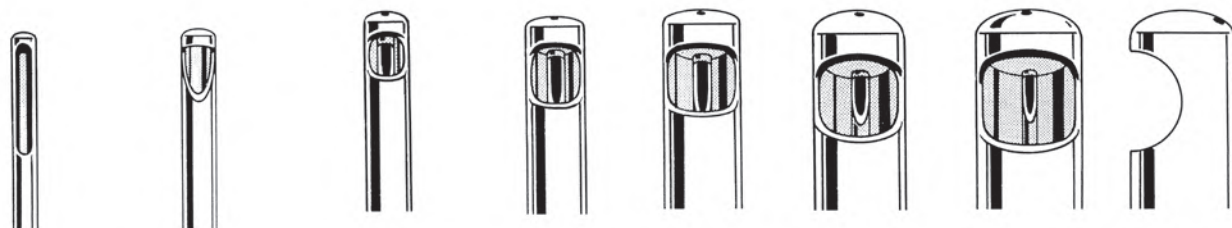

PC 30-8477-03 3 mm Ø    PC 30-8478-04 4,5 mm Ø    PC 30-8479-06 6 mm Ø    PC 30-8480-08 8 mm Ø    PC 30-8481-10 10 mm Ø    PC 30-8482-12 12 mm Ø    PC 30-8483-14 14 mm Ø    PC 30-8484-50

- Abortion Cannulas ●— EN
- Abtreibungskanülen ●— DE
- Aborto cannulas ●— ES





- EN —●— Obstetric Hooks
- DE —●— Beckenzirkel
- ES —●— Ganchos p/partos



**SMELLIE**  
PC 30-8487-33  
33.0cm



**BRAUN**  
PC 30-8488-30  
30.0cm



PC 30-8489-26  
26.0cm



**TARGETT**  
PC 30-8490-30  
30.0cm



**RAMATHIBODI**  
PC 30-8491-00



**IUD**  
PC 30-8492-00



PC 30-8493-00



**IUD**  
PC 30-8494-00

Pelvimeters ●— EN  
 Beckenzirkel ●— DE  
 Pelvimetros ●— ES



**COLLYER**  
 PC 30-8495-33 33.0cm  
 cm / inch scale



**DELEE**  
 PC 30-8496-20 20.0cm  
 cm / inch scale



**MARTIN**  
 PC 30-8497-34 34.0cm  
 PC 30-8498-34 34.0cm  
 cm / inch scale



**COLLIN**  
 PC 30-8499-35  
 35.0cm  
 cm scale



**BREISKY**  
 PC 30-8500-33  
 33.0cm  
 cm / inch scale

- EN** Goitre
- DE** Kropfchirurgie
- ES** Bocio

Page 741



- EN —● Goitre Enucleator, Goitre Grasping Forceps
- DE —● Kropfsonden, Kropffasszangen
- ES —● Sondas para bocio, Pinzas para coger el bocio

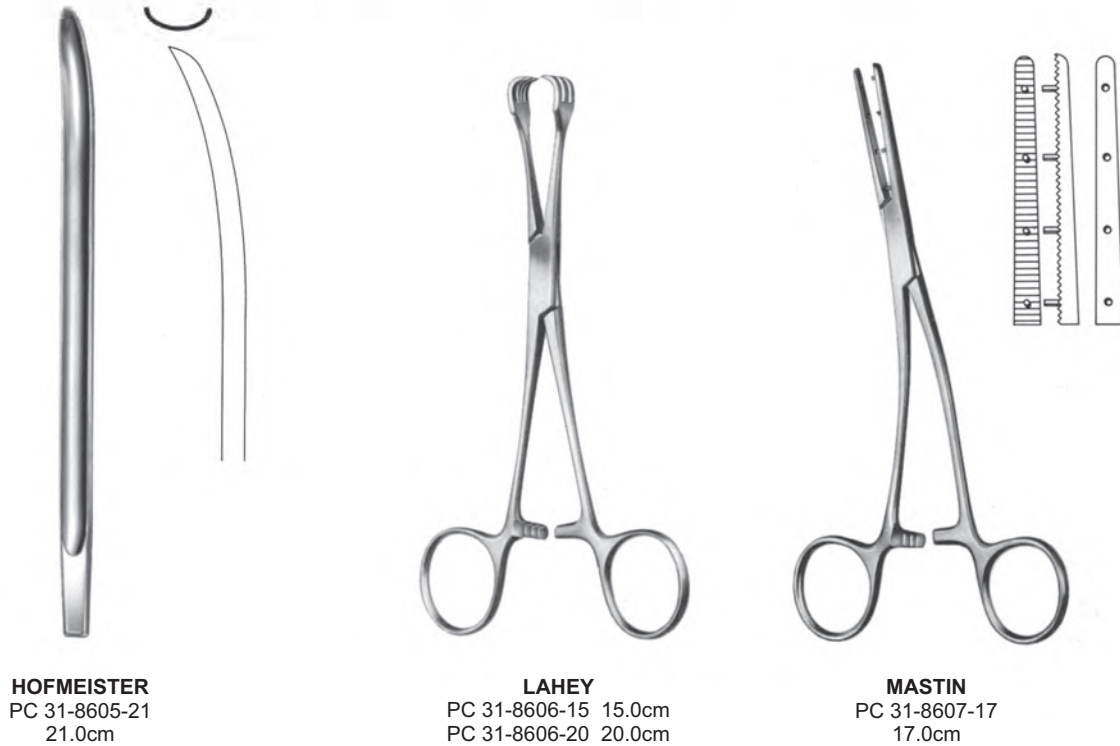

- EN** Sterilization
- DE** Sterilisation
- ES** Esterilización

Page 742 to 743





- EN —● Sterilizing Forceps  
 DE —● Sterilisierzangen  
 ES —● Pinzas para esterilización



**CHEATLE**  
 PC 32-8701-27  
 27.0cm

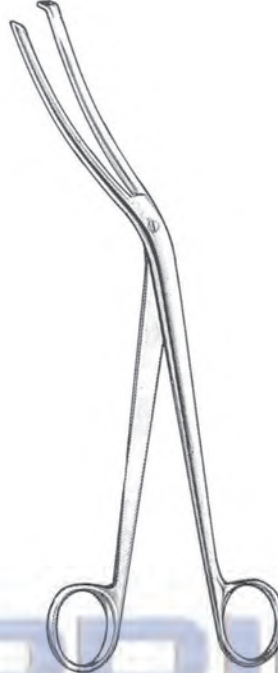

**CHEATLE**  
 PC 32-8702-26  
 26.5cm



**CHEATLE**  
 PC 32-8703-28  
 28.0cm



PC 32-8704-20 20.0cm  
 PC 32-8704-30 30.0cm



**ROGGE**  
 PC 32-8705-23  
 23.0cm



**DAVIS**  
 PC 32-8706-16 16.0cm  
 PC 32-8706-20 20.0cm  
 PC 32-8706-24 24.0cm

Sterilizing Forceps and Safety Pins ●— EN  
 Sterilisierzangen, Sterilisierklammern ●— DE  
 Pinzas para esterilización, Porta-instrumentos ●— ES



**UNIVERSAL**  
 PC 32-8707-20 20.0cm  
 PC 32-8707-28 28.0cm



**UNIVERSAL**  
 PC 32-8708-20 20.0cm  
 PC 32-8708-28 28.0cm



**PYE-SMITH (HARRISON)**  
 PC 32-8709-25 25.0cm  
 PC 32-8709-30 30.0cm

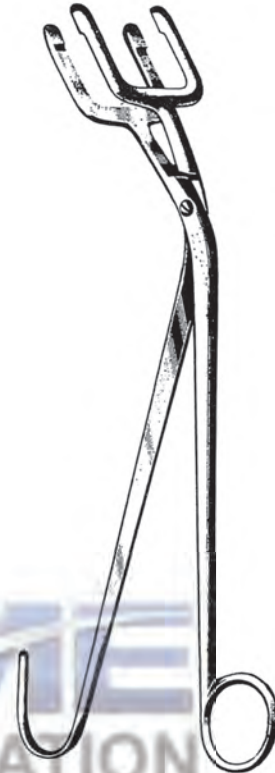

**HARRISON**  
 PC 32-8710-25 25.0cm  
 PC 32-8710-30 30.0cm  
 PC 32-8710-35 35.0cm  
 PC 32-8710-45 45.0cm

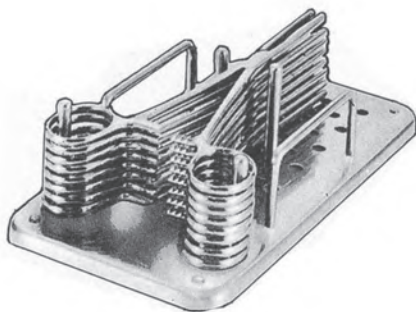

PC 32-8711-00



**BUNT**  
 PC 32-8712-12 12.0cm



**MAYO**  
 PC 32-8713-10 10.0cm  
 PC 32-8713-12 12.0cm  
 PC 32-8713-14 14.0cm  
 PC 32-8713-15 15.0cm



**MAYO**  
 PC 32-8714-14 14.0cm

**EN** Asepsis

**DE** Asepsis

**ES** Asepsia

**Page 744 to 745**

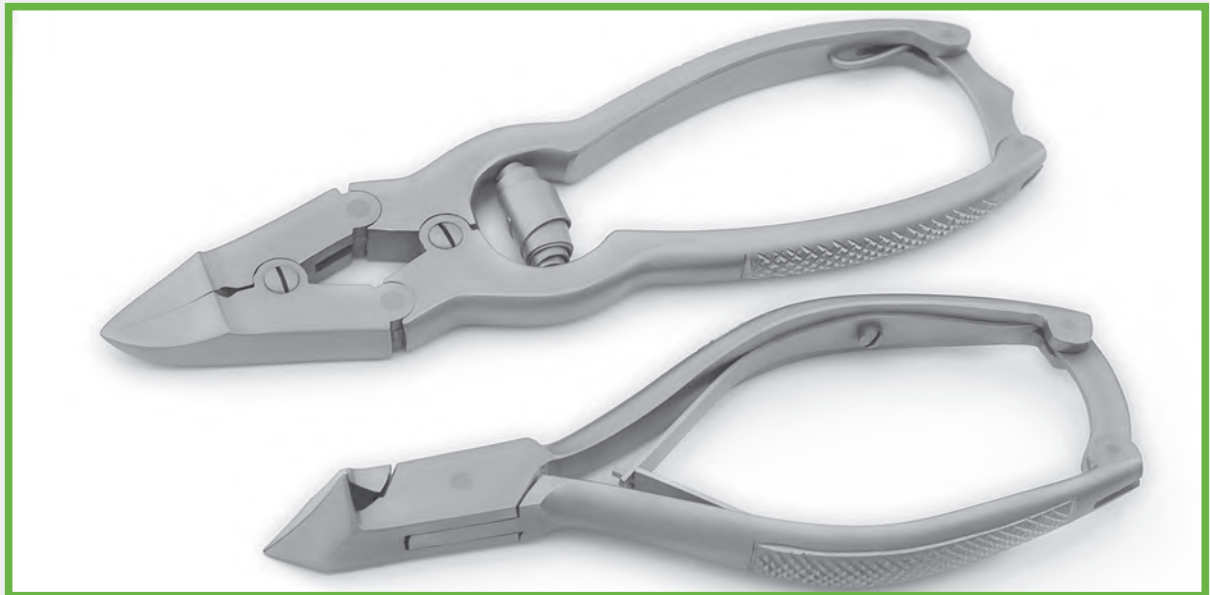

- EN —● Cuticle Scissors, Cuticle Nippers, Nail Files
- DE —● Hautscheren, Nagelhautzangen, Nagelfeilen
- ES —● Pinzas y tijeras cuticulares, limas para unhas

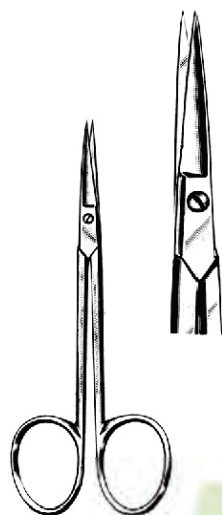

PC 33-8801-10  
10.5 cm/4"

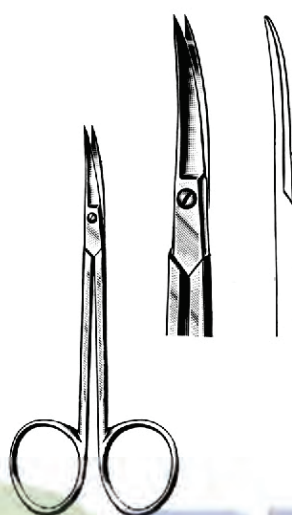

PC 33-8802-10  
10.5 cm/4"

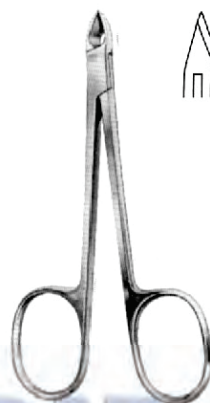

PC 33-8803-10  
10.5 cm/4"

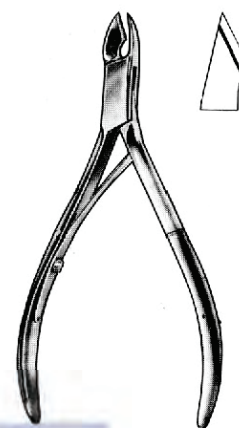

PC 33-8804-10 10.5 cm/4"  
PC 33-8804-11 11.5 cm/4 1/2"  
PC 33-8804-13 13 cm/5"



PC 33-8805-10 10.5 cm/4"  
PC 33-8805-11 11.5 cm/4 1/2"  
PC 33-8805-13 13 cm/5"  
PC 33-8805-15 15 cm/6"

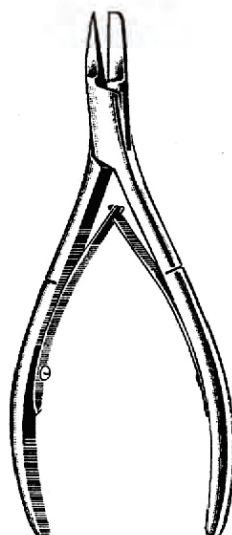

**INGROWN TOE NAIL FORCEPS  
ENGLISH (ANVIL) PATTERN**  
PC 33-8806-12  
12.5 cm/5"



PC 33-8807-10 10 cm/4"  
PC 33-8807-12 12 cm/5"



PC 33-8808-16  
16 cm/6 1/2"



Nail Scissors, Nippers ●— EN  
 Nagelscheren, Nagelzangen ●— DE  
 Tijeras para unhas, pinzas corta-unhas ●— ES

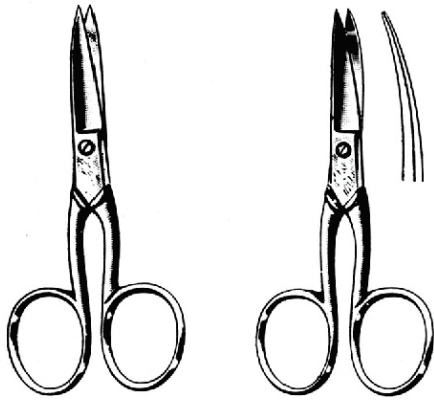

PC 33-8809-09 9 cm/3 1/2" PC 33-8810-09  
 PC 33-8809-10 10 cm/4" PC 33-8810-10  
 PC 33-8809-11 11cm/4 1/2" PC 33-8810-11

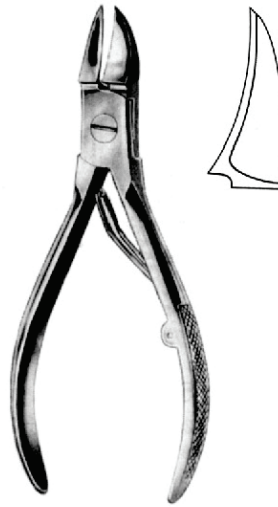

PC 33-8811-12 12 cm/5"  
 PC 33-8811-13 13 cm/5 1/4"

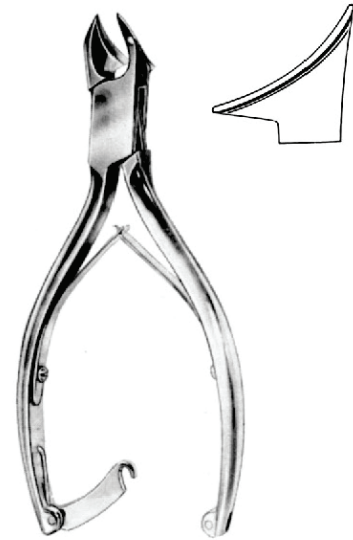

PC 33-8812-14  
 14 cm/5 1/2"

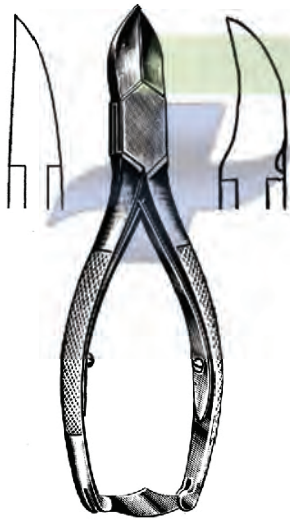

PC 33-8814-14 14 cm/5 1/2"  
 PC 33-8814-16 16 cm/6 1/2"



**TURNBULL**  
 PC 33-8815-11 11 cm/4 1/2"  
 PC 33-8815-13 13 cm/5"



**NAIL NIPPER  
 Double Action**  
 PC 33-8816-15  
 15 cm/6"

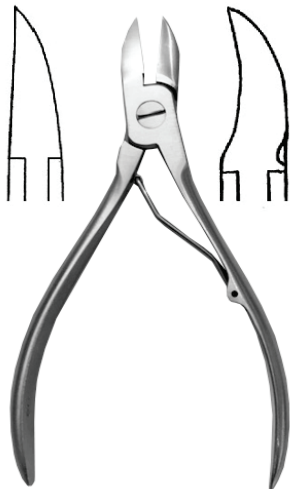

PC 33-8817-12 12 cm/5" PC 33-8818-12  
 PC 33-8817-13 13 cm/5 1/2" PC 33-8818-13



PC 33-8819-15  
 S/E



PC 33-8820-15  
 D/E



**EN** Hollowware

**DE** Hollowware

**ES** Hollowware

**Page 746 to 753**



- EN** —● Needle Case, Endodontic Box, Tube Rack, Cotton Holder,
- DE** —● Needle Case, Endodontic Box, Tube Rack, Cotton Holder
- ES** —● Caso aguja, Caja de endodoncia, bastidor de tubo



**Needle Case Round with Cover**  
PC 34-8901-01 65x15mm



**Needle Case Round**  
PC 34-8902-01 80x20mm



**Needle Case Rectangle**  
PC 34-8903-01 70x70x10mm

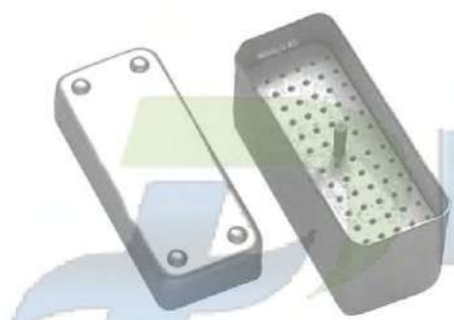

**Endodontic Box**  
PC 34-8904-01  
100x40x50mm

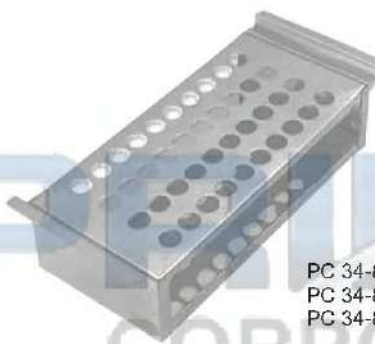

**Tube Rack**

- PC 34-8905-01 6.35x15.25x5cm for 12 tubes
- PC 34-8905-02 6.35x17.75x7.5cm for 27 tubes
- PC 34-8905-03 7.50x17.75x6.35cm for 36 tubes



**Sprit Lamp**  
PC 34-8906-01  
Standard Size



**Sprit Lamp**  
PC 34-8907-01  
Standard Size



**Sputum Cup**  
PC 34-8908-01 75x80mm  
PC 34-8908-02 100x50mm  
PC 34-8908-03 100x80mm

Jars, Jallipot, Bowls, Cups — EN  
 Jars, Jallipot, Schalen, Becher — DE  
 Frascos, Jallipot, tazones, tazas — ES



**Dressing Jar**

PC 34-8909-01	80x60mm	PC 34-8910-01
PC 34-8909-02	80x80mm	PC 34-8910-02
PC 34-8909-03	100x100mm	PC 34-8910-03
PC 34-8909-04	120x120mm	PC 34-8910-04
PC 34-8909-05	150x150mm	PC 34-8910-05
PC 34-8909-06	180x180mm	PC 34-8910-06
PC 34-8909-07	200x200mm	PC 34-8910-07



**Dressing Jar**



**Fennle**

PC 34-8912-01	100mm Ø
PC 34-8912-02	120mm Ø
PC 34-8912-03	150mm Ø
PC 34-8912-04	200mm Ø



**Cotton Holder**  
PC 34-8911-01

**Cotton Holder**  
PC 34-8911-02



**Forceps Jar**

PC 34-8913-01	30x90mm
PC 34-8913-02	50x125mm
PC 34-8913-03	50x170mm
PC 34-8913-04	50x200mm
PC 34-8913-05	40x230mm
PC 34-8913-06	70x110mm
PC 34-8913-07	80x150mm
PC 34-8913-08	100x200mm
PC 34-8913-09	150x30mm



**Gallipot**

PC 34-8914-01	01 oz	PC 34-8914-09	09 oz
PC 34-8914-02	02 oz	PC 34-8914-10	10 oz
PC 34-8914-03	03 oz	PC 34-8914-11	11 oz
PC 34-8914-04	04 oz	PC 34-8914-12	12 oz
PC 34-8914-05	05 oz	PC 34-8914-13	13 oz
PC 34-8914-06	06 oz	PC 34-8914-14	14 oz
PC 34-8914-07	07 oz	PC 34-8914-15	15 oz
PC 34-8914-08	08 oz	PC 34-8914-16	16 oz



**Spong Bowl**

PC 34-8915-01	12 cm
PC 34-8915-02	15 cm
PC 34-8915-03	20 cm

- EN —● Cup, Bowl, Kedney Trays  
 DE —● Cup, Schüssel, Nierenschalen  
 ES —● Copa, Bowl, bandejas de riñón

**Medicine Cup**

PC 34-8916-01 50ml  
 PC 34-8916-02 60ml  
 PC 34-8916-03 70ml

**Lotion Bowl without spout**

PC 34-8917-01 40x19mm	PC 34-8917-08 150x65mm
PC 34-8917-02 50x25mm	PC 34-8917-09 180x85mm
PC 34-8917-03 60x30mm	PC 34-8917-10 200x100mm
PC 34-8917-04 80x40mm	PC 34-8917-11 250x120mm
PC 34-8917-05 100x50mm	PC 34-8917-12 300mm
PC 34-8917-06 120x60mm	PC 34-8917-13 350mm
PC 34-8917-07 140x60mm	PC 34-8917-14 400mm

**Wash Basin**

PC 34-8918-01 300x80mm  
 PC 34-8918-02 320x85mm  
 PC 34-8918-03 330x90mm  
 PC 34-8918-04 350x110mm  
 PC 34-8918-05 400x115mm

**Kick Bucket with Trolley**

PC 34-8919-01  
 390x280x180mm

**Kidney Tray Shallow**

PC 34-8920-01 17cm  
 PC 34-8920-02 22cm  
 PC 34-8920-03 24cm

**Kidney Tray**

PC 34-8921-01 12cm  
 PC 34-8921-02 15cm  
 PC 34-8921-03 18cm  
 PC 34-8921-04 20cm  
 PC 34-8921-05 25cm  
 PC 34-8921-06 28cm  
 PC 34-8921-07 30cm

**Kidney Tray (with cover)**

PC 34-8922-01 15cm  
 PC 34-8922-02 20cm  
 PC 34-8922-03 25cm  
 PC 34-8922-04 30cm



Wire Mesh Trays, Instruments Trays — EN  
 Maschendraht-Tablets, Instrumentarium Trays — DE  
 Las bandejas de malla de alambre — ES

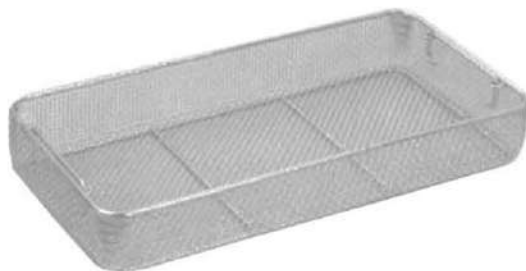

**Wire Mesh Tray**

- PC 34-8923-01 240x250x5mm
- PC 34-8923-02 480x250x5mm
- PC 34-8923-03 550x250x5mm
- PC 34-8923-04 240x250x7mm
- PC 34-8923-05 480x250x7mm
- PC 34-8923-06 240x250x10mm
- PC 34-8923-07 480x250x10mm

**Wire Mesh Tray with Lid**

- PC 34-8924-01 240x250x5mm
- PC 34-8924-02 480x250x5mm
- PC 34-8924-03 550x250x5mm
- PC 34-8924-04 240x250x7mm
- PC 34-8924-05 480x250x7mm
- PC 34-8924-06 240x250x10mm
- PC 34-8924-07 480x250x10mm



**Perforated Tray**

- PC 34-8925-01 200x100x40mm
- PC 34-8925-02 250x120x50mm
- PC 34-8925-03 300x150x50mm
- PC 34-8925-04 350x170x50mm
- PC 34-8925-05 400x200x50mm

**Instruments Tray without Lid**

- PC 34-8926-01 100x150x25mm
- PC 34-8926-02 150x200x40mm
- PC 34-8926-03 200x250x45mm
- PC 34-8926-04 250x300x50mm
- PC 34-8926-05 300x350x50mm
- PC 34-8926-06 150x300x50mm
- PC 34-8926-07 200x300x50mm
- PC 34-8926-08 230x150x50mm

**Instruments Tray with Lid**

- PC 34-8927-01 100x150x25mm
- PC 34-8927-02 150x200x40mm
- PC 34-8927-03 200x250x45mm
- PC 34-8927-04 250x300x50mm
- PC 34-8927-05 300x350x50mm
- PC 34-8927-06 150x300x50mm
- PC 34-8927-07 200x300x50mm
- PC 34-8927-08 230x150x50mm



- EN — Instruments Tray, Instruments Boxes  
 DE — Instrumente Tray, Instrumente Boxen  
 ES — Bandeja instrumentos, Instrumentos Cajas



**Burr Tray**  
PC 34-8928-01  
190x100x20mm



**Cathetes Tray with Lid**  
PC 34-8929-01 300x80x40mm  
PC 34-8929-02 350x90x45mm  
PC 34-8929-03 400x100x50mm



**Scaler Tray with cover**  
PC 34-8930-01  
200x100x16mm



**Instruments Box  
with Hooks**

PC 34-8931-01 170x70x30mm  
 PC 34-8931-02 180x80x40mm  
 PC 34-8931-03 200x100x40mm  
 PC 34-8931-04 230x120x50mm  
 PC 34-8931-05 250x125x50mm  
 PC 34-8931-06 300x150x50mm  
 PC 34-8931-07 350x170x50mm  
 PC 34-8931-08 400x200x90mm  
 PC 34-8931-09 500x200x120mm



**Instruments Box**

PC 34-8932-01 170x70x30mm  
 PC 34-8932-02 180x80x40mm  
 PC 34-8932-03 200x100x40mm  
 PC 34-8932-04 230x120x50mm  
 PC 34-8932-05 250x125x50mm  
 PC 34-8932-06 300x150x50mm  
 PC 34-8932-07 350x170x50mm  
 PC 34-8932-08 400x200x90mm  
 PC 34-8932-09 500x200x120mm

Instruments Box, Sterilization Box ● EN  
 Instrumente Box, Sterilisation Box ● DE  
 Instrumentos de pelo, caja de esterilización ● ES



**Instruments Box Perforated**  
 PC 34-8933-01 200x100x40mm  
 PC 34-8933-02 250x150x40mm  
 PC 34-8933-03 300x150x40mm



**Electric Sterilizer**  
 PC 34-8934-01 200x100x120mm  
 PC 34-8934-02 250x120x140mm  
 PC 34-8934-03 300x150x150mm  
 PC 34-8934-04 350x170x170mm  
 PC 34-8934-05 400x200x180mm  
 PC 34-8934-06 450x230x190mm



**Non Electric Sterilizer**  
 PC 34-8935-01 200x100x65mm  
 PC 34-8935-02 250x125x65mm  
 PC 34-8935-03 300x150x100mm  
 PC 34-8935-04 350x170x65mm  
 PC 34-8935-05 400x200x100mm



**Electric Sterilizer**  
 PC 34-8936-01  
 280x125x65mm

- PC 34-8937-01 125x80mm
- PC 34-8937-02 125x120mm
- PC 34-8937-03 150x100mm
- PC 34-8937-04 150x150mm
- PC 34-8937-05 180x180mm
- PC 34-8937-06 190x140mm
- PC 34-8937-07 190x190mm
- PC 34-8937-08 200x200mm
- PC 34-8937-09 240x120mm
- PC 34-8937-10 240x240mm
- PC 34-8937-11 290x140mm
- PC 34-8937-12 290x240mm
- PC 34-8937-13 290x290mm
- PC 34-8937-14 340x160mm
- PC 34-8937-15 340x340mm
- PC 34-8937-16 390x150mm
- PC 34-8937-17 390x200mm
- PC 34-8937-18 390x290mm



**Sterilizer Drum**

- EN —● Bedpan  
 DE —● Bettpfanne  
 ES —● Calentador de cama



**Bedpan Hand Made**  
 PC 34-8938-01  
 Standard



**Bedpan Hand Made**  
 PC 34-8939-01 Adult  
 PC 34-8939-02 Child



**Bedpan Hand Made**  
 PC 34-8940-01  
 Standard



**Bedpan Simple**  
 pressed body with handle  
 PC 34-8942-01 Adult  
 PC 34-8942-02 Child



**Bedpan Sleeper Type**  
 PC 34-8943-01 Adult  
 PC 34-8943-02 Child



**Bedpan Chamber Port**  
 PC 34-8944-01  
 Standard



Urinal, Bedpan, Bucket, Jug ● EN  
 Pissoir, Bedpan, Eimer, Krug ● DE  
 Urinario, Bedpan, Cubo, Jarro ● ES



**Urinal Female**  
 PC 34-8945-01  
 Standard

**Urinal Male Vertical**  
 PC 34-8946-01  
 Standard

**Urinal Male**  
 PC 34-8947-01  
 Standard



**Bedpan perfection type seamless**  
 PC 34-8948-01  
 350x300mm

**Bedpan perfection type**  
 PC 34-8949-01 370x290mm  
 PC 34-8949-02 320x240mm



**Measuring Jug**  
 PC 34-8950-01 0.5 Ltr  
 PC 34-8950-02 1.0 Ltr  
 PC 34-8950-03 1.5 Ltr  
 PC 34-8950-04 2.0 Ltr



**Pail/Bucket with Lid**  
 PC 34-8951-01 06 Ltr  
 PC 34-8952-02 10 Ltr  
 PC 34-8952-03 15 Ltr



**Douch Can/Irrigator**  
 PC 34-8952-01 1.0 Ltr  
 PC 34-8952-02 1.5 Ltr  
 PC 34-8952-03 2.0 Ltr



## **Pakistan Address**

Mundeke-Berian, Pasrur  
Sialkot, Pakistan  
Contact Person: Asif Munir Bajwa  
(Chief Executive)  
Cell: +92 300 4201777  
Telephone: +92 333 4201777  
info@primesialkot.com  
www.primesialkot.com

## **Italy Address**

Italy Office Via Cadorna, 2A  
39100-Bolzano (BZ)  
Cell: + 39 349 222 4550  
Email: info@primesialkot.com